

## SEM Specimen Stubs

### Short Pin Type

#### Aluminium

$\frac{1}{2}$ "  $\varnothing$  (12.5mm) with 3.2mm  $\varnothing$ , 8mm long pin with groove for Cambridge/LEO, Philips, Etec etc instruments.

<b>S081</b>	$\frac{1}{2}$ " Pin type stub (with groove)	pack of 100
<b>S081/I</b>	$\frac{1}{2}$ " Pin type stub (with groove)	pack of 1000
<b>S081/HP</b>	$\frac{1}{2}$ " Pin type stub (with groove) high purity Al for analysis apps	pack of 100
<b>S081/T</b>	$\frac{1}{2}$ " Pin type sticky tab stub	pack of 1000
<b>S081/T1</b>	$\frac{1}{2}$ " Pin type sticky tab stub	pack of 100
<b>S182</b>	$\frac{1}{2}$ " Pin type stub (without groove)	pack of 100
<b>S433</b>	$\frac{1}{2}$ " Pin type stub (with groove) Pin 3.2mm $\varnothing$ , 6mm long	for LEO pack of 100
<b>S434</b>	$\frac{1}{2}$ " Pin type stub (no groove) Pin 3.2mm $\varnothing$ , 6mm long	for LEO pack of 100

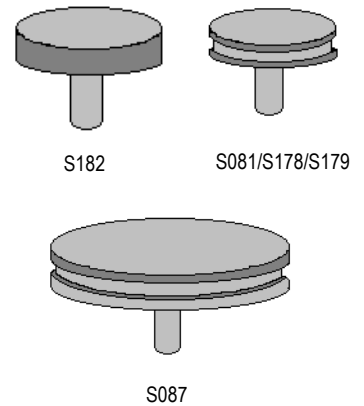

#### Brass

**S178**  $\frac{1}{2}$ " Pin type stub (with groove) pack of 10

#### Copper

**S179**  $\frac{1}{2}$ " Pin type stub (with groove) pack of 10

**1"  $\varnothing$  (25.4mm)** Aluminium Short Pin type stub with 3.2mm  $\varnothing$ , 8mm long pin for Cambridge/LEO and Philips instruments.

**S087** 1" Pin type stub pack of 50



**32mm  $\varnothing$**  Aluminium Short Pin type stub with 3.2mm  $\varnothing$  pin for Camscan

**S181** 32mm  $\varnothing$  pin type stub pack of 50

### Long Pin Type

Aluminium  $\frac{1}{2}$ "  $\varnothing$  (12.5mm) with 3.2mm  $\varnothing$  pin 15mm long for Amray

**S180**  $\frac{1}{2}$ " Amray pin stub pack of 50

### Re-entry Type

32mm ( $1\frac{1}{4}$ "  $\varnothing$ ) re-entry (dish) type stub for Cambridge/LEO

**S091** 32mm ( $1\frac{1}{4}$ "  $\varnothing$ ) Aluminium re-entry type stub pack of 50

### Cylinder Type

Plain cylindrical aluminium stubs for JEOL instruments

<b>S187</b> 12.5mm $\varnothing$ x 15mm high	pck of 50	<b>S189</b> 50mm $\varnothing$ x 10mm high	pck of 50
<b>S183</b> 10mm $\varnothing$ x 3.5mm high	pck of 50	<b>S084</b> 15mm $\varnothing$ x 5mm high	pck of 50
<b>S082</b> 10mm $\varnothing$ x 5mm high	pck of 50	<b>S085</b> 15mm $\varnothing$ x 10mm high	pck of 50
<b>S083</b> 10mm $\varnothing$ x 10mm high	pck of 50	<b>S086</b> 15mm $\varnothing$ x 15mm high	pck of 50
<b>S184</b> 10mm $\varnothing$ x 12.5mm high	pck of 50	<b>S089</b> 32mm $\varnothing$ x 5mm high	pck of 50
<b>S185</b> 12.5mm $\varnothing$ x 5mm high	pck of 50	<b>S090</b> 32mm $\varnothing$ x 10mm high	pck of 50
<b>S186</b> 12.5mm $\varnothing$ x 10mm high	pck of 50	<b>S188</b> 32mm $\varnothing$ x 20mm high	pck of 50

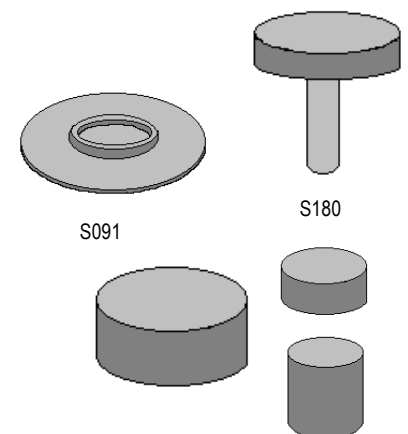

### Re-entry Type Stub Adapter

A simple, effective adapter to convert 12.5mm ( $\frac{1}{2}$ " pin stubs to allow 32mm ( $1\frac{1}{4}$ "  $\varnothing$ ) re-entry dish type stubs to be used on  $\frac{1}{8}$ " stage. The ball catch gives a trouble free, quick solution to a difficult problem.

**S261** SEM stub adapter - re-entry stub



### Chamfered Type

Aluminium stubs with a chamfered angle of 45° suitable for **JEOL** or **ISI** instruments where fitting stages are not available.

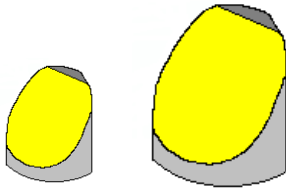

<b>S127</b>	Angled stub 10mm Ø	pack of 10
<b>S190</b>	Angled stub 12.5mm Ø	pack of 10
<b>S126</b>	Angled stub 15mm Ø	pack of 10

### Threaded Type

Aluminium stubs threaded with M4 female thread in base for **Hitachi** instruments.

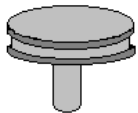
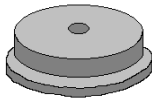
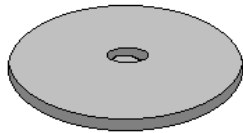

Types S100/101

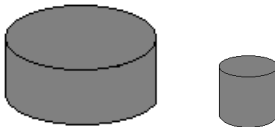

Types S102/103/104/105

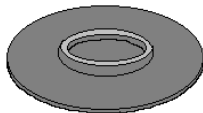

S106/107

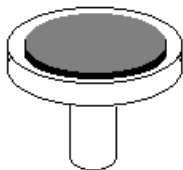

<b>S128</b>	Threaded stub 15mm Ø x 6mm high	pack of 50
<b>S191</b>	Threaded stub 25mm Ø x 6mm high	pack of 50
<b>S192</b>	Threaded stub 32mm Ø x 2mm high	pack of 50
<b>S193</b>	Threaded stub 32mm Ø x 10mm high	pack of 50

### Carbon Stubs

Where the background radiation from the specimen stub is troublesome, a specimen stub manufactured from spectroscopic carbon may be used. Stubs for **Cambridge/LEO**, **JEOL** and **ISI** microscopes are available. They can have a *standard* finish or an *ultra smooth* finish for small particles or fibres.

<b>S100</b>	Carbon stub for Cambridge/LEO standard finish	each
<b>S101</b>	Carbon stub for Cambridge/LEO <i>ultra smooth</i> finish	each
<b>S102</b>	Carbon stub for JEOL (10 Ø x 10mm H) standard	each
<b>S103</b>	Carbon stub for JEOL (10 Ø x 10mm H) <i>ultra smooth</i>	each
<b>S104</b>	Carbon stub for ISI (15mm Ø x 10mm H) standard	each
<b>S105</b>	Carbon stub for ISI (15mm Ø x 10mm H) <i>ultra smooth</i>	each
<b>S106</b>	Carbon stub for Cambridge microanalysis stage std	each
<b>S107</b>	Carbon stub for Cambridge m/analysis stage <i>u/smooth</i>	each

### Carbon Disc on Stub

This is an economical solution to the need for a light element surface for mounting specimens that are to be used for microanalysis. The carbon disc is 3mm thick and is glued to a standard ½" (12.5mm) stub.

Supplied in batches of 8 stubs in a stub storage box.

**S111** Box of 8 carbon covered ½" (12.5mm) stubs

### Beryllium Discs (Planchettes)

An alternative to carbon as a support for certain applications. Two types are available:

1) 50µm Beryllium laminate on a copper support to give excellent price/performance. The laminate Be/Cu is thick enough to reduce background radiation to levels achieved by solid Be. In addition, the ductile Cu layer will inhibit fracture of the brittle Be.

<b>D211</b> Be/Cu disc 1cm Ø x 0.25mm thick	<b>D214</b> Be/Cu disc 50.8mm Ø x 1mm thick
<b>D212</b> Be/Cu disc 1.27cm Ø x 0.25mm thick	<b>D215</b> Be/Cu disc 101.6mm Ø x 1mm thick
<b>D213</b> Be/Cu disc 2.5cm Ø x 1mm thick	<b>D216</b> Be/Cu disc 203.2mm Ø x 2mm thick

The above are also available with a *raised and numbered grid* for easy location in the SEM

<b>D217</b> Be/Cu disc 1cm Ø x 0.25mm	<b>D219</b> 2.5cm Ø x 1mm
<b>D218</b> Be/Cu disc 1.27cm Ø x 0.25mm	

2) Solid beryllium discs 50µm thick

<b>D220</b> Be disc 10mm Ø	<b>D221</b> Be disc 12.5mm Ø	<b>D222</b> Be disc 25mm Ø
----------------------------	------------------------------	----------------------------

## Preparation Stand for SEM Specimens

A cylindrical aluminium block for holding up to 10 specimen mounts for attachment of, or manipulation of samples. A rubber 'O' ring retains the mounts.

<b>M168</b>	Mounting block - pin stubs	each
<b>M169</b>	Mounting block - 10mm cylinders	each

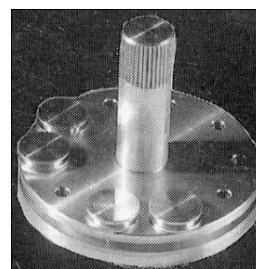

## Storage Boxes for SEM

TAAB offers a range of storage boxes that will accept specimen mounts in common use. The units consist of a transparent plastic box containing a white plastic insert. The specimen mounts are a push fit into the appropriate holes and do not shake loose during transportation. There is sufficient height above the specimen (approx. 12mm) to permit the storage of very thick mounted specimens. An identification label is enclosed to record specimens.

<b>B098</b>	Storage box for 8 x 1/2" pin type mounts	each
<b>B157</b>	Storage box for 8 x 10mm Ø mounts	each
<b>B099</b>	Storage box for 8 x 15mm Ø mounts	each
<b>B158</b>	Storage box for 3 x 32mm dish type mounts	each

B098

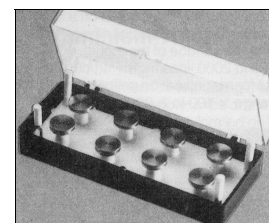

B097

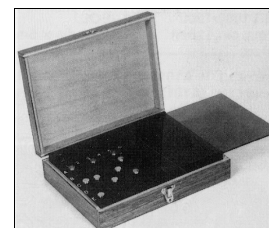

### Wooden Box

<b>B097</b>	Storage box for 54 x 1/2" pin type mounts	each
-------------	---	------

### SEM-STOR Economical Storage

Sem-Stor is the answer to economical storage of SEM specimens. It is made from cardboard and has a fold-up insert that takes 8 specimen mounts of the 1/2" pin type. The front lip of the box is cut away for convenient observation and handling of stubs. Shipped flat, makes up into a 7 x 3.8 x 3.5cm high box.

<b>B135</b>	Sem-Stor cardboard storage box for 1/2" mounts	each
<b>B135/1</b>	Sem-Stor cardboard storage box for 1/2" mounts	per 100

B135



## Single Stub Storage Tube

For storage or transportation. The SEM stub pin is a tight push fit inside the cap that is then placed in the clear acrylic tube. A secure and effective method for post or pocket.

<b>T350</b>	Single stub storage tube	pack of 5
<b>T350/1</b>	Single stub storage tube	pack of 25

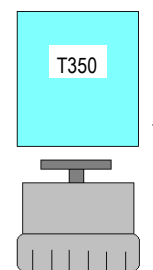

## Tweezers for Stubs

Tweezers specially designed for handling 1/2" specimen stubs commonly used in SEM.

<b>T137</b>	Tweezer for 1/2" stubs	each
-------------	------------------------	------

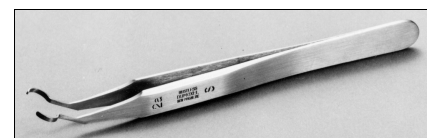

T137

**T330** SEM stub handling tool - A simple robust tool to fit 12.5mm pin stubs as an alternative to T137 suitably angled to allow convenient handling of the stubs in confined areas. The beryllium copper prongs allow a firm grip to be repeatedly achieved without loss of spring tension.

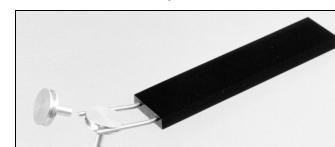

T330

### Tweezer for Hitachi Stubs

<b>T329</b>	Special tweezer for handling 15mm Ø Hitachi stubs	each
-------------	---	------

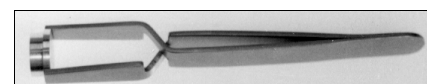

T329

## SEM Specimen/Stub Adhesives

A listing of many different adhesive methods for attaching specimens to SEM mounts.

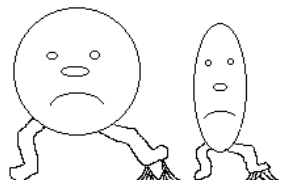
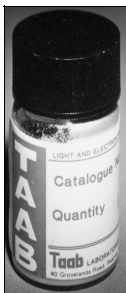

### Colloidal Graphite

A suspension of pure, fine colloidal graphite in water or in isopropanol based solution. To form a conducting dry film of graphite on a variety of materials.

<b>C107</b>	Colloidal graphite - aqueous base	500g
<b>C126</b>	Colloidal graphite - isopropanol base	500g

### Silver Paint

An air drying paint containing silver flakes. Dries to form a conducting film that is ideal for sample mounting.

<b>S269</b>	Silver paint	10g
<b>S270</b>	Silver paint	50g

#### Silver Paint Thinners

A thinner to reduce the thickness of our silver paint S066 to make thin conductive tracks on the specimen for microprobe work.

<b>S271/1</b>	Silver Paint Thinners	25ml
<b>S271</b>	Silver paint thinners	100ml

### Silver Epoxy Adhesive

A two part silver filled epoxy adhesive providing a conducting joint and bond. *Silver content 70%*. Information sheet provided with each pack.

<b>S055</b>	Silver epoxy adhesive	pack of 10g
-------------	-----------------------	-------------

### Conducting Carbon Cement (Leit-C)

A suspension of very fine carbon particles in a volatile carrier. Suitable for forming a conducting film bond between specimen or carbon disc to stub.

<b>C198</b>	Carbon cement (Leit-C)	30g
<b>C198/1</b>	Thinners for Leit-C	30ml

### Leit-C Plast

A plasticine like material with low outgassing properties suitable for use in the high vacuum of the SEM. Leit-C Plast is a conductive material requiring no additional coating and is suitable for many applications in specimen preparation.

<b>C199</b>	Leit-C-Plast	15g
-------------	--------------	-----

### Tempfix

A thermoplastic adhesive that when applied to a heated stub at approximately +40°C yields a sticky surface suitable for holding specimens. It dries quickly to a very smooth surface and remains stable under the SEM.

<b>T328</b>	Tempfix	set
-------------	---------	-----

### Microstik

A clear adhesive for mounting small particles. Provides an ultrathin base when applied to the SEM specimen mount. Dries quickly and is non-conductive

<b>M167</b>	Microstik solution	14ml
-------------	--------------------	------

## Conducting Film Aerosol

A rapid method of spraying a conductive film onto SEM specimens such as pieces of biological tissue. Effects are not permanent so it is ideal for rapid examination in the SEM.

**C212** Conducting film aerosol 397ml can

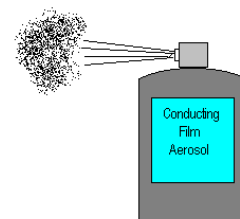

## Carbon Discs

A range of discs 3mm thick with diameters of 12.5mm, 15mm or 25mm for mounting specimens in the SEM.

**C304/10** Carbon discs 12.5mm Ø pack of 10    **C305** Carbon disc 15mm Ø  
**C305/10** Carbon discs 15mm Ø pack of 10    **C306** Carbon disc 25mm Ø  
**C306/10** Carbon discs 25mm Ø pack of 10

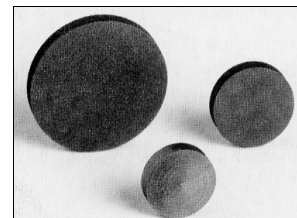

## Conductive Carbon Adhesive Discs

**For SEM stubs.** An improvement on double sided tape. These new doubly adhesive carbon based discs ensure good electrical connection whilst retaining the benefits of a quick mounting method.

**C263/N** 9mm Ø pack of 100  
**C249/N** 12mm Ø pack of 100  
**C252/N** 25mm Ø pack of 51

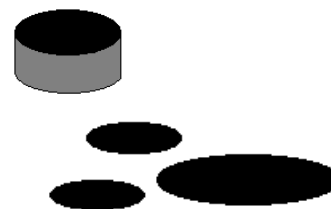

## Sulphur-Free Conductive Carbon Discs

Adhesive discs with low background for microanalysis

**C272** Sulphur-free conductive carbon tabs 12mm Ø pack of 120



## Double Sided Sticky Carbon Tape

Highly conductive tape for SEM and EDS applications. The double adhesive and conductive design permits quick mounting of samples without using liquid or colloidal adhesives. The tape is relatively solid and non-porous and does not absorb small samples. Thickness is 0.16mm.

**C261** Carbon tape 8mm x 20m long each  
**C277** Carbon tape 12mm x 20m long each  
**C278** Carbon tape 50mm x 20m long each

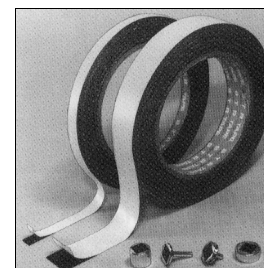

## Conductive Carbon Adhesive Sheet

For SEM or EDS we have available double sided carbon sheet for eliminating background X-rays. When cut to size it is easy to place on SEM stubs and is contaminant free.

**C206** Carbon conductive adhesive sheet 5 x 12cm pack of 10



## Sticky Tabs

Sticky tabs may be affixed to most types of stubs. Once affixed to the top of a stub simply remove the peel-off tab to leave a 1/2" (12.7mm) Ø layer of adhesive to which small specimens can be fixed, or impressions such as fingerprints can be made in the adhesive for examination. Non conducting and the strong silicone adhesive does not outgas in the vacuum. The adhesive can be removed with acetone.

**T199** Sticky tabs pack of 100

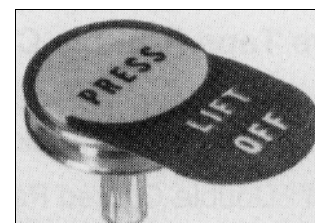

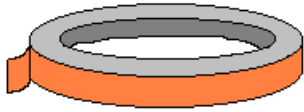

### Copper Tape

Copper strip with pressure sensitive adhesive backing. Ideal for static charging problems etc.

**T188** Copper tape 12mm x 16m per roll



### Aluminium Tape

Two sizes of aluminium strip with pressure sensitive adhesive backing. Ideal for conductive connections etc.

**T189** Al tape 12mm x 55m x 0.09mm per roll **T189/1** As T189 but 0.13mm thick

**T190** Al tape 25mm x 55m x 0.09mm per roll **T190/1** As T190 but 0.13mm thick



### Magic Tape

This 3M tape is transparent when affixed to objects and makes amending and updating documents easy. It is ideal for making small labels being easy to type or write on and is invisible on photocopies.

**T191** Magic tape 12mm x 66m per roll

**T523** Magic tape 25mm x 66m per roll

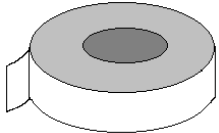

### Double Sided Tape

A thin double sided sticky tape in two widths suitable for mounting specimens and for general SEM work.

**T063** Double sided tape 12mm x 66m per roll

**T064** Double sided tape 38mm x 66m per roll

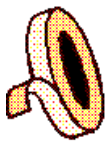

### Silver Conducting Adhesive Sheet

Highly electrically conductive sheet 5 x 12 x 0.16cm thick suitable for cutting and sizing to samples for SEM.

- Little outgassing under vacuum
- Doesn't absorb or penetrate specimens

**S331** Silver conductive sheet pack of 5

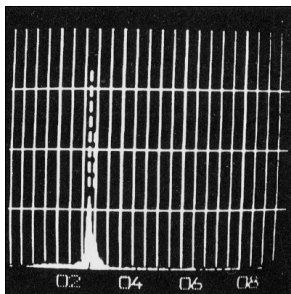

EDS spectrum of silver sheet S331

### Silicon Chip Specimen Supports

Si-chips are opaque, of low electrical resistance and have surface properties equal to glass. They are chemically inert and make good substrates for growing or mounting cells or ferritin particles. They are useful for determining resolution and contrast capabilities of the "in-the-lens" SEMs equipped with high brightness electron emitters. Si-chips are precleaned before packing

**S332** 4" (10cm) silicon wafer diced into approx. 270 chips 5 x 5mm

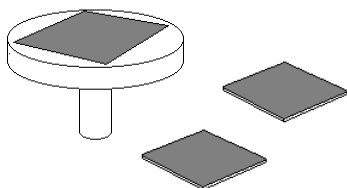

## Scintillator Discs

### Plano P47 Scintillator Discs

These discs are highly recommended for routine use, being coated with a very uniform layer of carefully selected P47 phosphor. They have a high signal output and a good working life. They should not normally be coated with aluminium unless cathodoluminescence studies are envisaged. An aluminium coating reduces the efficiency by some 20%. Discs are available for all principal types of microscopes. Special sizes are available on request.



### YAG Single Crystal Scintillator Discs

Yttrium Aluminium Garnet has a very fast response time of 50-60 ns and unlike plastic or most phosphor scintillators they do not degrade when bombarded by electrons or ions. They are very suitable for high current operations and have a very long lifetime. Light emission peaks about 560nm, response time below 5kV is better with YAG than for P47. The crystal should be coated with 50nm of aluminium before use. If the layer becomes damaged it can be removed with sodium hydroxide without damaging the surface of the crystal. The crystal is mounted with the matt surface in contact with the light pipe as this has been shown to increase efficiency.

The discs are all 1mm thick unless otherwise specified.

### YAP Single Crystal Scintillator Discs

Yttrium Aluminium Perovskite crystals are more efficient in light output than YAG (see graph). Also the emission spectrum peaks at about 378nm which corresponds closely to the maximum sensitivity of the S11 photo multiplier that is in general use in most electron microscopes. There is therefore a significant improvement in signal by using the YAP crystal rather than the YAG. The decay time of YAP crystals is 40ns compared with YAG of 80ns, so overall performance of YAP is superior to YAG.

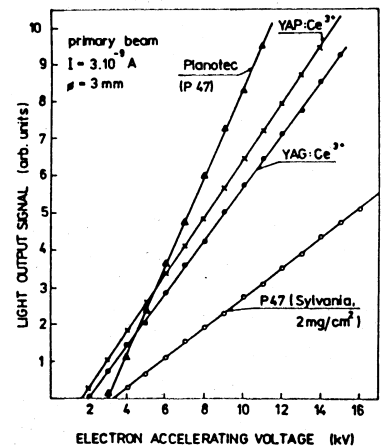

## Usage Chart

Diameter	Instrument	P47	YAG	YAP
7.7mm	ISI Mini SEM	S214	S214/G	S214/P
8.8 x 2mm	JEOL, JSM, T20, T200, 840	S215	S215/G	S215/P
9.0 x 3mm	ETEC	S216	S216/G	S216/P
10.0mm	Cambridge/LEO (except S600), AMR1200	S217	S217/G	S217/P
12.0mm	Cambridge S600	S218	S218/G	S218/P
12.0 x 0.17mm	Zeiss SEM	S219	S219/G	S219/p
12.4 x 3.2mm	Cameca	S220	S220/G	S220/P
13.7mm	ISI, JEOL	S221	S221/G	S221/P
16.4 x 0.17mm	Zeiss, Novascan, Semco/Zeiss	S222	S222/G	S222/P
18.0mm	Camscan/Balscan	S223	S223/G	S223/P
19.8mm	Hitachi with metal ring	S224	S224/G	S224/P
20.0mm	JEOL except JSM T20, T200, 840, AMR1000, 1400, 1600, 1700	S225	S225/G	S225/P
20.0 x 2mm	Philips	S226	S226/G	S226/P



### Phosphor Powder

For those wishing to prepare their own scintillator discs, TAAB offers a P47 phosphor powder to a specification recommended for scintillator coating.

**P065** Phosphor powder P47 25g

### SEM Specimen Holders and Mounts

A wide range of multi stub and specimen mounting clamps for SEMs is available to fit most scanning electron microscopes that extend the range and versatility of the instrument. They allow either a number of stubs to be loaded into the SEM at the same time as in the case of the multi stub holder or alternatively samples of irregular shape can be examined by use of one of the specimen clamping devices. The clamping devices can also be used where it is difficult or impossible to attach a sample to a normal stub.

When ordering please give full details of the SEM including accessories.

### Multi Stub Holder

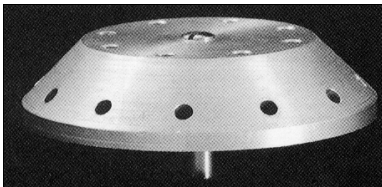

This holder will accommodate 20 pin type stubs 12 at an angle of 45°, 8 horizontal. The top part of the holder has been removed allowing samples to be examined at zero tilt. The holder may need factory modification to match the microscope to which it is to be fitted. Please state make and model of SEM.

**S163** Multi stub holder 65mm Ø x 15mm H for SEM specimen stubs

### Bar Clamp

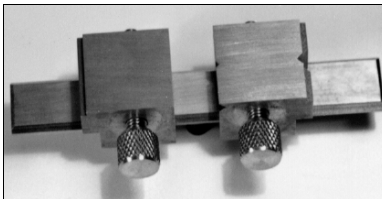

This bar type specimen clamp has a standard pin stub type mount on the reverse side and will accommodate specimens up to 72mm wide. The reversible jaws operate independently allowing the area of interest to be positioned accurately within the travel limits of the microscope stage. When ordering please specify model of microscope, stage type in use, and any other accessories such as X-ray or back scattered detectors.

*Overall length* 102mm      *Width including jaw mechanism* 42mm  
*Width of bar* 16mm      *Height (excl base mount)* 19mm

**S160** Bar clamp

### Thumbwheel Clamp

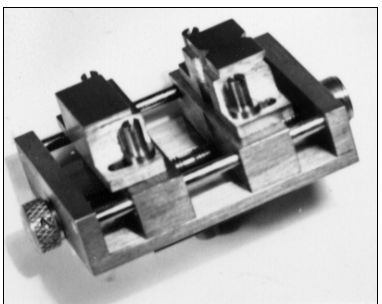

The thumbwheel clamp has single operation symmetrical vice motion with reversible clamping bars to give different sized indentations to clamp irregular shaped specimens. Two models are available for specimens up to 34mm or up to 51mm

**S161** Thumbwheel clamp 34mm  
*Base length* 62mm (including thumbwheel mechanism 72mm)  
*Width* 42mm, *Height (excl base mount)* 27mm, *Max jaw opening* 34mm

**S162** Thumbwheel clamp 51mm  
*Base length* 82mm (including thumbwheel mechanism 96mm)  
*Width* 58mm, *Height (excl base mount)* 30mm, *Max jaw opening* 51mm



S402

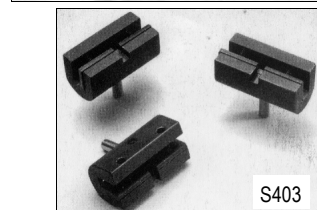

S403

### Slotted Specimen Stubs

1) A 12.5mm slotted aluminium pin stub with two Allen screws allowing the specimen to be securely clamped for examination. Allen key supplied.

**S402** Slotted specimen stub with two screws

2) A gripping pin stub with slot and single screw to allow specimens to be mounted edge-on for examination (designed at the University of Leicester).

**S403** Gripping stub



## Multi Stub Holder - Flat

A carousel style multiple pin stub holder that will hold eight 12.7mm pin stubs.

**S396** Multi stub holder, flat (please state make and model of SEM)

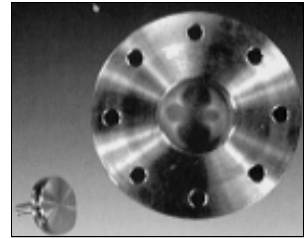

## Multi Stub Holder - Flat Top

This flat top holder permits seven (7) 12.5mm pin stubs to be loaded into the SEM at one time.

*Overall diameter* 39mm      *Height (excl base mount)* 16mm

**S296** Multi stub holder - flat top for Hitachi

**S296/A** Multi stub holder - flat top for other instruments (please specify)

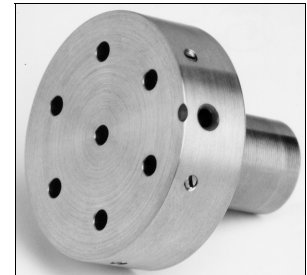

## Multi Stub Holder - Conical

Conical shaped pin stub holder. Will fit Hitachi SEM stages without affecting standard tilt and rotation. Accepts six (6) stubs at an angle of 45°.

*Overall diameter* 39mm      *Height (excl base mount)* 16mm

**S164** Multi stub holder - conical for Hitachi

**S164/A** Multi stub holder - conical for other makes (please specify)



## Specimen Clamp

This clamp is supplied with five interchangeable jaws for accommodating samples of different sizes. Maximum width is 20mm.

*Overall length* 39mm,      *Overall width* 26mm,      *Height (excl base mount)* 16mm

**S165** Specimen clamp for Hitachi

**S165/A** Specimen clamp for other makes (please specify)

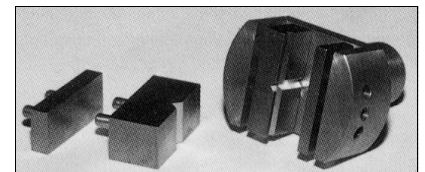

## Stub Adapters

These adapters allow JEOL, ISI/ABT and Hitachi users to accommodate the standard pin stubs of the European and American manufacturers. The conversion cylinder contains a clip to hold the pin stub.

**S367** Converter for JEOL, 10mm Ø cylinder

**S367/1** Converter for JEOL, 12.5mm Ø cylinder

**S367/2** Converter for ISI/ABT, 15mm Ø cylinder

**S367/3** Converter for Hitachi, 15mm Ø cylinder with M4 internal thread

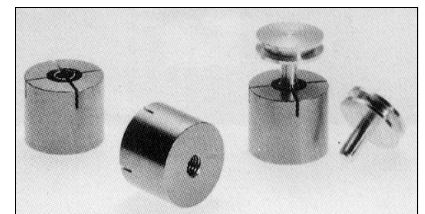

## Lacomit Varnish and Remover

For those who wish to prepare thinned TEM specimens by one of the 'window' techniques, Lacomit is a peelable varnish for blanking off the portions of the specimen that are not to be polished. A solvent remover is also available. Both reagents are flammable and special transportation and limitations apply for shipping overseas.

**L063** Lacomit varnish 500ml

**L064** Lacomit remover 500ml

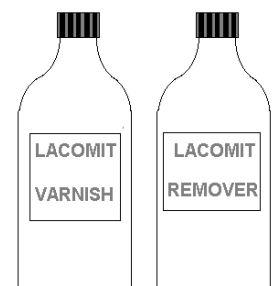



### M-Bond™ 610 Adhesive

A non-conductive two-component, solvent-thinned, epoxy-phenolic adhesive for high performance applications. Chemically resistant providing a thin layer of glue with good ion milling properties. Has low viscosity with minimum creep, hysteresis and linearity problems. Solids content is 22%. It is an excellent adhesive for mounting samples for TEM dimpling and bonding of samples to TEM grids for imaging or FIB. Operating temperature range short term is -269° to +370°C; long term, -269° to +260°C.

This may be the widest temperature range general-purpose adhesive that is available.

Kit contains: Resin (4 bottles 14g each) Curing Agent (4 bottles 11g each), 4 brush caps for dispensing mixed adhesives, 4 disposable mixing funnels and instructions.

**AXXX**



### Hitachi Three Stub Holder

An aluminium holder with M4 thread that will accommodate three 15mm Hitachi stubs.

**S397** Hitachi holder for three stubs



### Hitachi Holder for Six Pin Stubs

An aluminium holder with M4 thread to accommodate six pin stubs.

**S398** Hitachi holder for 6 pin stubs



### Freeze Drying Holder for Pin Stubs

A holder for five 12.7mm pin stubs for drying, carbon or metal coating.

Dimensions: 37.5mm Ø x 12.5mm high

**S399** Freeze drying, metal coating holder



### SEM Stub for TEM Grids

In some applications (e.g. some SEM/EDX) results are improved if particulate samples are mounted on thin films deposited onto TEM grids. This pin-type aluminium stub allows four grids to be held securely for SEM work. There is a hole under each grid to reduce the backscatter component in electron collection and prevent extraneous X-ray collection.

**S400** SEM stub aluminium (pin-type) for TEM grids

**S401** SEM stub copper (pin-type) for TEM grids for cryo applications

### SEM Finder Grid

This finder grid incorporates several easy location features for the identification of areas of special interest. Grid available in copper, nickel or gold.

- The annular ring identifies North, East, South and West
- The four quadrant markers are tapered towards the centre
- 100 radial sectors are easily identified by reference to decimal numbers in the annular rim and alphabet letters in the four quadrants
- A matt surface on one side is for correct positioning - matt side up

Overall diameter 10mm

Thickness 50µm

**G198/C** SEM finder grid *copper* (10)

**G198/N** SEM finder grid *nickel* (10)

**G198/G** SEM finder grid *gold* (5)

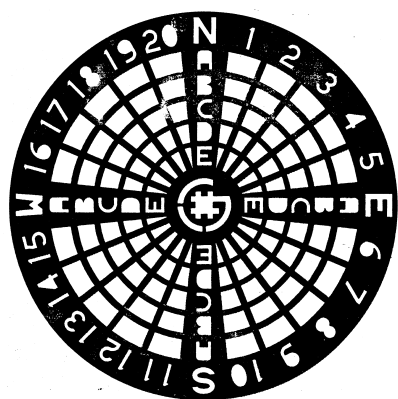

## AFM/STM/SPM Accessories

### Highly Orientated Pyrolytic Graphite

H.O.P.G is widely used as a substrate for AFM/STM specimens. It can also be used as a calibration specimen.

G260 H.O.P.G.

piece approx. 10 x 10 x 2mm

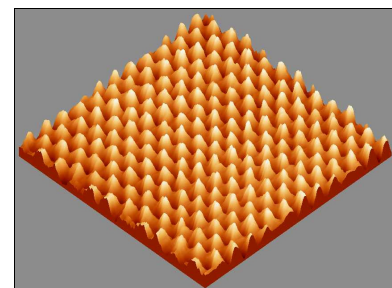

### SPM Metal Specimen Discs

These high quality discs for SPM are manufactured with smooth edges and consistently flat surfaces.

D245 SPM specimen discs, 12mm Ø, pack of 50

D246 SPM specimen discs, 15mm Ø, pack of 50

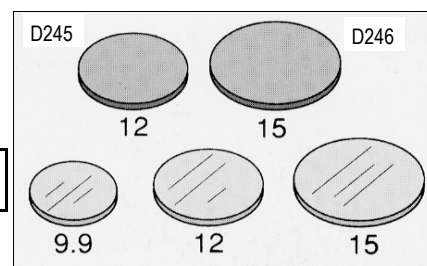

### Mica Mounting Discs and Glass Coverslips

An alternative to metal discs for certain applications.

M406 Mica discs 9.9mm Ø, pack of 10

M407 Mica discs 14mm Ø, pack of 10

C302 Round glass coverslips, 12mm Ø, box of 100

C303 Round glass coverslips, 15mm Ø, box of 100

### SPM Dispenser for Discs

An easy and clean way to store and dispense SPM discs. The plastic package containing the discs is inserted into the dispenser and a single disc can be dispensed with a simple turn of the cylinder. This can then be picked up using the disc gripper. The dispenser is suitable for 12 or 15mm Ø discs.

D247 SPM disc dispenser

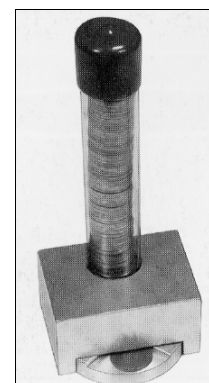

### Disc Gripper

A gripper specially designed to pick up discs from a flat surface without damage due to the rubber coated tips.

G199/12 Gripper for 12mm Ø discs

G199/15 Gripper for 15mm Ø discs

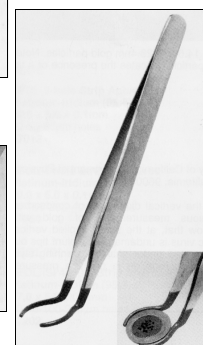
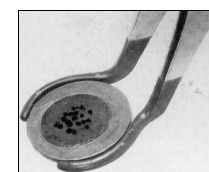

### Disc Carrier/Storage

A practical and dust-free way to store 12mm and 15mm Ø discs. Discs are placed face down in a stepped cavity that prevents damage to the specimen. The sliding cover secures the disc in position.

D248 Disc carrier to take ten (10) 12mm Ø discs

D249 Disc carrier to take eight (8) 15mm Ø discs

### Magnetic Pick-up Tool

A convenient magnetic tool for picking up and manoeuvring discs without damage to the specimen.

T543 Magnetic pick-up tool

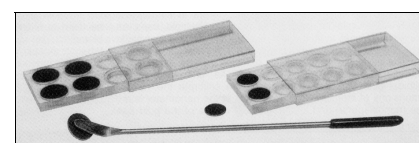

Magnetic Pick-up Tool

For up-to-date information visit our web page

[www.taab.co.uk](http://www.taab.co.uk)

This will enable you to download all or part of our catalogue as PDFs.

We can also source products not listed as standard in our catalogue so give us a call to find that elusive product on:

**++44(0)118 981 7775**

or

e-mail [sales@taab.co.uk](mailto:sales@taab.co.uk)

**TAAB**

**Laboratory & Microscopy**