

SEM Specimen Stubs

Short Pin Type

Aluminium

1/2" Ø (12.7mm) with 3.2mm Ø x 8mm long pin, with groove for **Cambridge/LEO, Philips, Etec** etc instruments.

S081	1/2" Pin type stub (with groove)	pack of 100
S081/N	As above with alpha/numeric numbering	min pack of 100
S081/1	1/2" Pin type stub (with groove)	pack of 1000
S081/HP	1/2" Pin type stub (with groove) high purity Al for analysis apps	pack of 100
S182	1/2" Pin type stub (without groove)	pack of 100

S433	1/2" Pin type stub (with groove) Pin 3.2mm Ø x 6mm long for LEO	pack of 100
S434	1/2" Pin type stub (no groove) Pin 3.2mm Ø x 6mm long for LEO	pack of 100

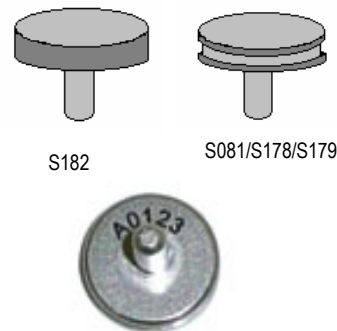

Please state sequence when ordering

Brass

S178	1/2" Pin type stub (with groove)	pack of 10
-------------	----------------------------------	------------

Copper

S179	1/2" Pin type stub (with groove)	pack of 10
-------------	----------------------------------	------------

1" Ø (25.4mm) Aluminium Short Pin type stub with 3.2mm Ø pin for **Cambridge/LEO** and **Philips** instruments.

S087	1" Pin type stub	pack of 50
-------------	------------------	------------

32mm Ø Aluminium Short Pin type stub with 3.2mm Ø pin for **Camscan**

S181	32mm Ø pin type stub	pack of 50
-------------	----------------------	------------

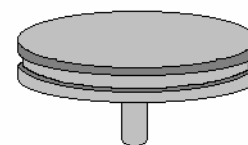

S087

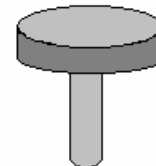

S180



S091

Long Pin Type

Aluminium 1/2" Ø (12.7mm) with 3.2mm Ø pin for **Amray**

S180	1/2" Amray pin stub	pack of 50
-------------	---------------------	------------

Re-entry Type

32mm (1 1/4") Ø re-entry (dish) type stub for **Cambridge/LEO**

S091	32mm (1 1/4") Ø Aluminium re-entry type stub	pack of 50
-------------	--	------------

Cylinder Type

Plain cylindrical aluminium stubs for **JEOL** instruments

S183	10mm Ø x 3.5mm high	pck of 50	S084	15mm Ø x 5mm high	pck of 50
S082	10mm Ø x 5mm high	pck of 50	S085	15mm Ø x 10mm high	pck of 50
S083	10mm Ø x 10mm high	pck of 50	S086	15mm Ø x 15mm high	pck of 50
S184	10mm Ø x 12.5mm high	pck of 50	S089	32mm Ø x 5mm high	pck of 50
S185	12.7mm Ø x 5mm high	pck of 50	S090	32mm Ø x 10mm high	pck of 50
S186	12.7mm Ø x 10mm high	pck of 50	S188	32mm Ø x 20mm high	pck of 50
S187	12.7mm Ø x 15mm high	pck of 50	S189	50mm Ø x 10mm high	pck of 50

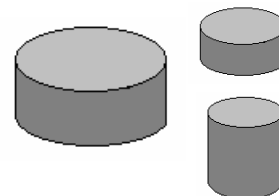

S261



Re-entry Type Stub Adapter

A simple, effective adapter to convert 12.7mm (1/2") pin stubs to allow 32mm (1.5") Ø re-entry dish type stubs to be used on 1/8" stage. The ball catch gives a trouble free, quick solution to a difficult problem.

S261	SEM stub adapter - re-entry stub
-------------	----------------------------------

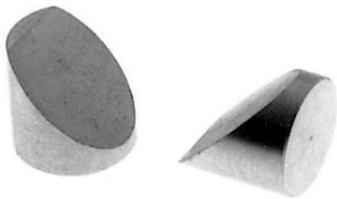

Chamfered Type

Aluminium stubs with a chamfered angle of 45° suitable for **JEOL** or **ISI** instruments where fitting stages are not available.

S127	Angled stub 10mm Ø	pack of 10
S190	Angled stub 12.7mm Ø	pack of 10
S126	Angled stub 15mm Ø	pack of 10

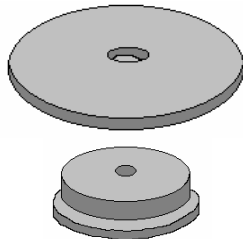

Threaded Type

Aluminium stubs threaded with M4 female thread in base for **Hitachi** instruments.

S128	Threaded stub 15mm Ø x 6mm high	pack of 50
S191	Threaded stub 25mm Ø x 6mm high	pack of 50
S192	Threaded stub 32mm Ø x 2mm high	pack of 50
S193	Threaded stub 32mm Ø x 10mm high	pack of 50

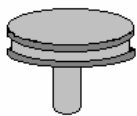

Types S100/101

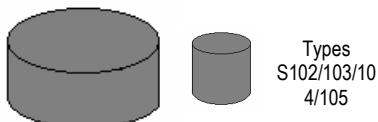
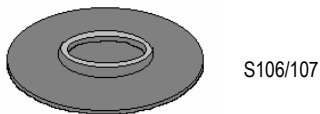
Types
S102/103/104/105

S106/107

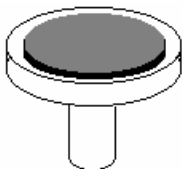

Carbon Stubs

Where the background radiation from the specimen stub is troublesome, a specimen stub manufactured from spectroscopic carbon may be used. Stubs for **Cambridge/LEO**, **JEOL** and **ISI** microscopes are available. They can have a *standard* finish or an *ultra smooth* finish for small particles or fibres.

S100	Carbon stub for Cambridge/LEO standard finish	each
S101	Carbon stub for Cambridge/LEO <i>ultra smooth</i> finish	each
S102	Carbon stub for JEOL (10mm Ø x 10mm H) standard	each
S103	Carbon stub for JEOL (10mm Ø x 10mm H) <i>ultra smooth</i>	each
S104	Carbon stub for ISI (15mm Ø x 10mm H) standard	each
S105	Carbon stub for ISI (15mm Ø x 10mm H) <i>ultra smooth</i>	each
S106	Carbon stub for Cambridge microanalysis stage std	each
S107	Carbon stub for Cambridge m/analysis stage <i>u/smooth</i>	each

Carbon Disc on Stub

This is an economical solution to the need for a light element surface for mounting specimens that are to be used for microanalysis. The carbon disc is 3mm thick and is glued to a standard ½" (12.7mm) stub.

Supplied in batches of 8 stubs in a stub storage box.

S111 Box of 8 carbon covered ½" (12.7mm) stubs



S402

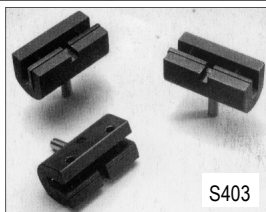

S403

Slotted Specimen Stubs

S402 A 12.5mm slotted aluminium pin stub with two Allen screws allowing the specimen to be securely clamped for examination. Allen key supplied.

S403 A gripping pin stub with slot and single screw to allow specimens to be mounted edge-on for examination (designed at the University of Leicester).

Stub Adapters

These adapters allow JEOL, ISI/ABT and Hitachi users to accommodate the standard pin stubs of the European and American manufacturers. The conversion cylinder contains a clip to hold the pin stub.

S367	Converter for JEOL, 10mm Ø cylinder
S367/1	Converter for JEOL, 12.5mm Ø cylinder
S367/2	Converter for ISI/ABT, 15mm Ø cylinder
S367/3	Converter for Hitachi, 15mm Ø cylinder with M4 internal thread

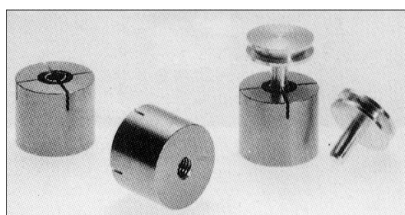

Specialised SEM Specimen Stubs

Stub for TEM Grids

In some applications (e.g. some SEM/EDX) results are improved if particulate samples are mounted on thin films deposited onto TEM grids. This pin-type aluminium stub allows four grids to be held securely for SEM work. There is a hole under each grid to reduce the backscatter component in electron collection and prevent extraneous X-ray collection.

- S400 SEM stub aluminium (pin-type) for TEM grids
- S401 SEM stub copper (pin-type) for TEM grids for cryo applications

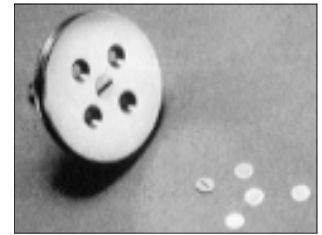

Pin Stubs with Engraved Divisions

Aluminium SEM pin mounts with **engraved and numbered** divisions for multiple smaller samples to fit **FEI/Philips, ZEISS/LEO, Cambridge, Leica, Amray, Tescan** and **Camscan** SEMs. Pin is 3.2mm (1/8") and 9mm (3/8") long. Quality machined smooth surface.

- | | | |
|--------|--------------------------------------|------------|
| S536 | 12.7mm Ø pin mount with 4 divisions | each |
| S536/1 | 12.7mm Ø pin mount with 4 divisions | pack of 10 |
| S537 | 19mm Ø pin mount with 4 divisions | each |
| S537/1 | 19mm Ø pin mount with 4 divisions | pack of 10 |
| S538 | 25.4mm Ø pin mount with 12 divisions | each |
| S538/1 | 25.4mm Ø pin mount with 12 divisions | pack of 10 |
| S539 | 32mm Ø pin mount with 12 divisions | each |
| S539/1 | 32mm Ø pin mount with 12 divisions | pack of 10 |

Pin Stubs

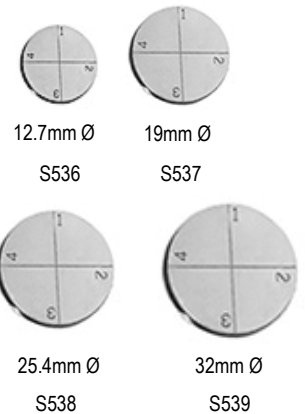

Special Size Aluminium Pin Stubs

- | | | |
|--------|--|-------------|
| S540 | SEM pin stub 6.4mm Ø diameter, standard pin | pack of 50 |
| S540/1 | SEM pin stub 6.4mm Ø diameter, standard pin | pack of 100 |
| S541 | SEM pin stub 12.7mm Ø with <i>Flat on side</i> | pack of 10 |
| S541/1 | SEM pin stub 12.7mm Ø with <i>Flat on side</i> | pack of 50 |
| S541/2 | SEM pin stub 12.7mm Ø with <i>Flat on side</i> | pack of 100 |
| S542 | SEM pin stub 38mm Ø with standard pin | each |
| S542/1 | SEM pin stub 38mm Ø with standard pin | pack of 10 |
| S543 | SEM pin stub 50mm Ø with standard pin | each |
| S543/1 | SEM pin stub 50mm Ø with standard pin | pack of 10 |
| S544 | SEM pin stub 63mm Ø with standard pin | each |
| S544/1 | SEM pin stub 63mm Ø with standard pin | pack of 10 |
| S545 | SEM pin stub 100mm Ø with standard pin | each |
| S545/1 | SEM pin stub 100mm Ø with standard pin | pack of 10 |



Angled Pin Stubs

- | | | |
|--------|--|------------|
| S546 | Pin stub swivel mount , 15mm Ø, 15mm pin | each |
| S547 | 45° angled <i>high profile</i> Al SEM pin stub 12.7mm Ø standard pin | pack of 5 |
| S548 | 45/90° angled <i>high profile</i> SEM pin stub 12.7mm Ø standard pin | each |
| S548/1 | 45/90° angled <i>high profile</i> SEM pin stub 12.7mm Ø standard pin | pack of 5 |
| S548/2 | 45/90° angled <i>high profile</i> SEM pin stub 12.7mm Ø standard pin | pack of 10 |
| S549 | 45° angled <i>standard profile</i> SEM pin stub 12.7mm Ø std pin | each |
| S549/1 | 45° angled <i>standard profile</i> SEM pin stub 12.7mm Ø std pin | pack of 5 |
| S549/2 | 45° angled <i>standard profile</i> SEM pin stub 12.7mm Ø std pin | pack of 10 |
| S550 | 45° angled <i>standard profile</i> SEM pin stub 25.4mm mm Ø std pin | each |
| S550/1 | 45° angled <i>standard profile</i> SEM pin stub 25.4mm mm Ø std pin | pack of 5 |
| S550/2 | 45° angled <i>standard profile</i> SEM pin stub 25.4mm mm Ø std pin | pack of 10 |
| S551 | 45/90° angled <i>standard profile</i> SEM pin stub 25.4mm Ø std pin | each |
| S551/1 | 45/90° angled <i>standard profile</i> SEM pin stub 25.4mm Ø std pin | pack of 5 |
| S551/2 | 45/90° angled <i>standard profile</i> SEM pin stub 25.4mm Ø std pin | pack of 10 |
| S660 | TV12 mini variable 0-90° angle tilt sample holder 11x12mm, std pin | each |
| S661 | TV25 variable 0-90° angle tilt holder for stubs up 38mm Ø, std pin | each |



Angled Pin Stubs cont..



S552	Double 45/90° angled SEM pin stub 25.4mm Ø standard Al pin	each
S552/1	Double 45/90° angled SEM pin stub 25.4mm Ø standard Al pin	pack of 5
S553	Double 90° SEM pin stub 25.4mm Ø standard pin Al pin	each
S553/1	Double 90° SEM pin stub 25.4mm Ø standard pin Al pin	pack of 5
S554	45/90° SEM pin stub 32mm Ø standard pin Al	each
S554/1	45/90° SEM pin stub 32mm Ø standard pin Al	pack of 5
S555	Double 90° SEM pin stub 32mm Ø standard pin Al pin	each
S555/1	Double 90° SEM pin stub 32mm Ø standard pin Al pin	pack of 5

SEM Pin Stubs with Extra Height



S556	Pin stub extender 12.7mm Ø x 22.7mm (10mm extra height)	each
S557	Pin stub 12.7mm Ø 4mm extra height std pin Al	pack of 5
S557/1	Pin stub 12.7mm Ø 4mm extra height std pin Al	pack of 10
S557/2	Pin stub 12.7mm Ø 4mm extra height std pin Al	pack of 50
S558	Pin stub 12.7mm Ø 6mm extra height std pin Al	pack of 5
S558/1	Pin stub 12.7mm Ø 6mm extra height std pin Al	pack of 10
S558/2	Pin stub 12.7mm Ø 6mm extra height std pin Al	pack of 50
S559	Pin stub 25.4mm Ø 4mm extra height std pin Al	pack of 5
S559/1	Pin stub 25.4mm Ø 4mm extra height std pin Al	pack of 10
S559/2	Pin stub 25.4mm Ø 4mm extra height std pin Al	pack of 50

SEM Pin Stubs Low Profile



S560	Low profile SEM pin stub 12.7mm Ø with 1mm height, Al	pack of 5
S560/1	Low profile SEM pin stub 12.7mm Ø with 1mm height, Al	pack of 10
S560/2	Low profile SEM pin stub 12.7mm Ø with 1mm height, Al	pack of 50
S561	Low profile pin stub 12.7mm Ø with 35° for Tescan, FIB x SEM	pack of 5
S561/1	Low profile pin stub 12.7mm Ø with 35° for Tescan, FIB x SEM	pack of 10
S561/2	Low profile pin stub 12.7mm Ø with 35° for Tescan, FIB x SEM	pack of 50
S562	Low profile pin stub 12.7mm Ø with 90° Al	pack of 5
S562/1	Low profile pin stub 12.7mm Ø with 90° Al	pack of 10
S562/2	Low profile pin stub 12.7mm Ø with 90° Al	pack of 50

Dish top Pin Stub

S563	SEM Dish pin stub, 12.7mm Ø x 7mm with 1.5mm dish depth Al	each
S563/1	SEM Dish pin stub, 12.7mm Ø x 7mm with 1.5mm dish depth Al	pack of 5
S563/2	SEM Dish pin stub, 12.7mm Ø x 7mm with 1.5mm dish depth Al	pack of 10

Specialised JEOL SEM Stubs

S564	JEOL 9.5mm Ø x 9.5mm angled SEM stub with 45° and 90° Al	pack of 10
S564/1	JEOL 9.5mm Ø x 9.5mm angled SEM stub with 45° and 90° Al	pack of 50
S565	JEOL 12.2mm Ø x 10mm angled SEM stub with 45° and 90° Al	pack of 10
S565/1	JEOL 12.2mm Ø x 10mm angled SEM stub with 45° and 90° Al	pack of 50
S566	JEOL 25mm Ø x 16mm angled SEM sample stub with 45° Al	pack of 5
S566/1	JEOL 25mm Ø x 16mm angled SEM sample stub with 45° Al	pack of 10
S567	JEOL 25mm Ø x 16mm SEM sample stub with 45° & 90° angles Al	each
S567/1	JEOL 25mm Ø x 16mm SEM sample stub with 45° & 90° angles Al	pack of 5
S568	JEOL 25mm Ø x 16mm SEM sample stub with double 90° Al	each
S568/1	JEOL 25mm Ø x 16mm SEM sample stub with double 90° Al	pack of 5
S569	JEOL Dish stub, 12.2mm Ø x 10mm with 1.5mm dish depth Al	pack of 10
S569/1	JEOL Dish stub, 12.2mm Ø x 10mm with 1.5mm dish depth Al	pack of 50
S646	Swivel mount sample holder with 1 clip on 15mm Ø plate on 12.2mm Ø JEOL stub	each

Specialised Hitachi SEM Stubs

S570	Hitachi 15mm Ø x 10mm M4 angled SEM sample stub 45° Al	each
S570/1	Hitachi 15mm Ø x 10mm M4 angled SEM sample stub 45° Al	pack of 10
S571	Hitachi 25mm Ø x 16mm M4 angled SEM sample stub 45° Al	each
S571/1	Hitachi 25mm Ø x 16mm M4 angled SEM sample stub 45° Al	pack of 10
S572	Hitachi 15mm Ø x 10mm M4 angled SEM sample stub 45° & 90° Al	each
S572/1	Hitachi 15mm Ø x 10mm M4 angled SEM sample stub 45° & 90° Al	pack of 10
S573	Hitachi 25mm Ø x 16mm M4 angled SEM sample stub 45° & 90° Al	each
S573/1	Hitachi 25mm Ø x 16mm M4 angled SEM sample stub 45° & 90° Al	pack of 10
S574	Hitachi 25mm Ø x 16mm M4 angled SEM stub, double 90° Al	each
S574/1	Hitachi 25mm Ø x 16mm M4 angled SEM stub, double 90° Al	pack of 10
S575	Hitachi 32mm Ø x 12mm M4 angled SEM sample stub 45° & 90° Al	each
S575/1	Hitachi 32mm Ø x 12mm M4 angled SEM sample stub 45° & 90° Al	pack of 10
S576	Hitachi 15mm Ø x 10mm M4 dish SEM sample stub, Al	pack of 5
S576/1	Hitachi 15mm Ø x 10mm M4 dish SEM sample stub, Al	pack of 10
S576/2	Hitachi 15mm Ø x 10mm M4 dish SEM sample stub, Al	pack of 50
S689	Hitachi stub swivel mount M4 15mm Ø x 30mm ± 90° Al/brass	each



Pin Stubs with SEM Sample Clips

The S-Clip sample holders comprise one or more spring loaded sample clips either on an SEM sample stub or holder. The spring loaded S-clips are specifically designed to hold thin specimens up to 2mm. Optional elevating (blocks) pillars are available to accommodate thicker samples. Washers can also be used to increase the clamping height.

The S-clips are made from conductive spring grade copper alloy mounted with a small M2 screw which allows the clip to rotate. Samples are clamped securely without the need for adhesives or conductive pastes. Sample changing is quick, easy and clean; contamination issues due to adhesives or glues are eliminated. They are ideal to hold Si chips and other thin samples. The S-Clip sample holders are available to hold samples horizontal (flat), at 45° or at 90°. The 45° and 90° are useful for holding cross sections of thin samples and wafer pieces. S-Clip sample holders are a cost effective alternative for the 1"-3" wafer holders. They can hold the smaller 1" (25.4mm), 2" (51mm) and 3" (76mm) wafers if it is allowed to hold the wafer down with clips:

38mm stub diameter is suitable for 1" (25.4mm) wafers; 63mm stub diameter is suitable for 2" (51mm) wafers and 100mm stub diameter is suitable for 3" (76mm) wafers.

The S-Clips are also separately available to enable customers to make their own custom made sample clip holders. Dimensions are 12.8mm long, tip is 1.6mm wide, height is 1.5mm with a 2.2mm Ø hole for mounting with an M2 screw. Made from 0.25mm thin spring grade copper alloy. Included with the S-clips are the M2 (x3) mounting screws.

S587	19mm Ø standard pin stub with 1 x S-Clip for FEI/Philips, LEO etc	
S588	19mm Ø short (6mm) pin stub with 1 x S-Clip for Zeiss	
S577/1	25mm Ø x 9mm pin stub with 1 clip for FEI/Philips, ZEISS/LEO, Cambridge,	each
S577/2	25mm Ø x 9mm pin stub with 2 clips for FEI/Philips, ZEISS/LEO, Cambridge,	each
S577/3	25mm Ø x 9mm pin stub with 3 clips for FEI/Philips, ZEISS/LEO, Cambridge,	each

Shorter version

S578/1	25mm Ø x 6mm pin stub with 1 clip for ZEISS/LEO, SEM, FIBs	each
S578/2	25mm Ø x 6mm pin stub with 2 clips for ZEISS/LEO, SEM, FIBs	each
S578/3	25mm Ø x 6mm pin stub with 3 clips for ZEISS/LEO, SEM, FIBs	each

S579/1	32mm Ø x 9mm pin stub with 1 clip for FEI/Philips, ZEISS/LEO, Cambridge,	each
S579/2	32mm Ø x 9mm pin stub with 2 clips for FEI/Philips, ZEISS/LEO, Cambridge,	each
S579/3	32mm Ø x 9mm pin stub with 3 clips for FEI/Philips, ZEISS/LEO, Cambridge,	each

S580/1	38mm Ø x 9mm pin stub with 1 clip for FEI/Philips, ZEISS/LEO, Cambridge,	each
S580/2	38mm Ø x 9mm pin stub with 2 clips for FEI/Philips, ZEISS/LEO, Cambridge,	each
S580/3	38mm Ø x 9mm pin stub with 3 clip for FEI/Philips, ZEISS/LEO, Cambridge,	each



Pin Stubs with Sample Clips cont...

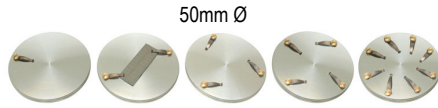

- S581/1** 50mm Ø x std pin stub with 1 clip for [FEI/Philips](#), [ZEISS/LEO](#), [Cambridge](#) each
- S581/2** 50mm Ø x std pin stub with 2 clips for [FEI/Philips](#), [ZEISS/LEO](#), [Cambridge](#) each
- S581/3** 50mm Ø x std pin stub with 3 clips for [FEI/Philips](#), [ZEISS/LEO](#), [Cambridge](#) each
- S581/4** 50mm Ø x std pin stub with 4 clips for [FEI/Philips](#), [ZEISS/LEO](#), [Cambridge](#) each
- S581/8** 50mm Ø x std pin stub with 8 clips for [FEI/Philips](#), [ZEISS/LEO](#), [Cambridge](#) each

- S582/1** 63mm Ø x std pin stub with 1 clip for [FEI/Philips](#), [ZEISS/LEO](#), [Cambridge](#) each
- S582/2** 63mm Ø x std pin stub with 2 clips for [FEI/Philips](#), [ZEISS/LEO](#), [Cambridge](#) each
- S582/3** 63mm Ø x std pin stub with 3 clips for [FEI/Philips](#), [ZEISS/LEO](#), [Cambridge](#) each
- S582/4** 63mm Ø x std pin stub with 4 clips for [FEI/Philips](#), [ZEISS/LEO](#), [Cambridge](#) each
- S582/8** 63mm Ø x std pin stub with 8 clips for [FEI/Philips](#), [ZEISS/LEO](#), [Cambridge](#) each

- S583/1** 100mm Ø x std pin stub with 1 clip for [FEI/Philips](#), [ZEISS/LEO](#), [Cambridge](#) each
- S583/2** 100mm Ø x std pin stub with 2 clips for [FEI/Philips](#), [ZEISS/LEO](#), [Cambridge](#) each
- S583/3** 100mm Ø x std pin stub with 3 clips for [FEI/Philips](#), [ZEISS/LEO](#), [Cambridge](#) each
- S583/4** 100mm Ø x std pin stub with 4 clips for [FEI/Philips](#), [ZEISS/LEO](#), [Cambridge](#) each
- S583/8** 100mm Ø x std pin stub with 8 clips for [FEI/Philips](#), [ZEISS/LEO](#), [Cambridge](#) each

S-Clips 45° & 90° on 25.4mm Ø & 12.7mm Ø Pin Stubs

- S589** S-Clip sample holder with 1 clip 45° on [25.4mm Ø](#) pin stub each
- S590** S-Clip sample holder swivel mount with 1 S-Clip on [25.4mm Ø](#) pin stub each
- S591** S-Clip sample holder with 2x S-Clips 45°/90° on [25.4mm Ø](#) pin stub each
- S592** S-Clip sample holder with 2x S-Clips double 90° on [25.4mm Ø](#) pin stub each
- S593** S-Clip sample holder with 1x S-Clip at 90° on [12.7mm Ø](#) pin stub each
- S594** S-Clip sample holder with 4x S-Clips at 90° on [12.7mm Ø](#) pin stub each
- S595** S-Clip sample holder with 4x S-Clips at 45° & 90° on pin stub each
- S596** S-Clip sample holder with 10x S-Clips at 90° on 10 x 50mm pin stub each

S-Clips on M4 Hitachi Stubs

- S597** S-Clip sample holder with 1x S-Clip on 15mm Ø x 10mm stub, M4 each
- S598** S-Clip sample holder with 1x S-Clip on 25mm Ø x 10mm stub, M4 each
- S598/2** S-Clip sample holder with 2x S-Clip on 25mm Ø x 10mm stub, M4 each
- S598/3** S-Clip sample holder with 3x S-Clip on 25mm Ø x 10mm stub, M4 each
- S599** S-Clip sample holder with 1x S-Clip on 32mm Ø x 10mm stub, M4 each
- S599/2** S-Clip sample holder with 2x S-Clip on 32mm Ø x 10mm stub, M4 each
- S599/3** S-Clip sample holder with 3x S-Clip on 32mm Ø x 10mm stub, M4 each
- S630** S-Clip sample holder with 1x S-Clip on 50mm Ø x 6mm stub, M4 each
- S630/2** S-Clip sample holder with 2x S-Clip on 50mm Ø x 6mm stub, M4 each
- S630/3** S-Clip sample holder with 3x S-Clip on 50mm Ø x 6mm stub, M4 each
- S630/4** S-Clip sample holder with 4x S-Clip on 50mm Ø x 6mm stub, M4 each
- S631** S-Clip sample holder with 1x S-Clip on 63mm Ø x 6mm stub, M4 each
- S631/2** S-Clip sample holder with 2x S-Clip on 63mm Ø x 6mm stub, M4 each
- S631/3** S-Clip sample holder with 3x S-Clip on 63mm Ø x 6mm stub, M4 each
- S631/4** S-Clip sample holder with 4x S-Clip on 63mm Ø x 6mm stub, M4 each
- S631/8** S-Clip sample holder with 8x S-Clip on 63mm Ø x 6mm stub, M4 each
- S632** S-Clip sample holder with 1x S-Clip on 100mm Ø x 6mm stub, M4 each
- S632/2** S-Clip sample holder with 2x S-Clip on 100mm Ø x 6mm stub, M4 each
- S632/3** S-Clip sample holder with 3x S-Clip on 100mm Ø x 6mm stub, M4 each
- S632/4** S-Clip sample holder with 4x S-Clip on 100mm Ø x 6mm stub, M4 each
- S632/8** S-Clip sample holder with 8x S-Clip on 100mm Ø x 6mm stub, M4 each

S-Clips on M4 Hitachi Stubs 45° & 90°

- S633** S-Clip sample holder 45° with 1x S-Clip on 25mm Ø stub M4 each
S634 S-Clip sample holder 45°/90° with 2x S-Clip on 25mm Ø stub M4 each
S634/A S-Clip sample holder double 90° with 2x S-Clip on 25mm stub M4 each
S635 S-Clip sample holder 90° with 4x S-Clip on 12.7x12.7mm Ø stub M4 each
S636 S-Clip sample holder with 4x S-Clips at 45° & 4x S-Clips at 90°, M4 each
S637 S-Clip sample holder with 10x S-Clips at 90°, 10x50mm, stub M4 each



Spare S-Clip Screws & Elevating Blocks

- S638** 5 Copper alloy S-Clips with 5 each brass M2 x 3mm screws set
S639 6 each S-Clip elevating pillars, 4mm height, M2 x3mm male/female set



S-Clips on Flat JEOL Specimen Stubs

- S640** S-Clip sample holder with 1x S-Clip on 25mm Ø x 10mm JEOL SEM stub each
S640/2 S-Clip sample holder with 2x S-Clip on 25mm Ø x 10mm JEOL SEM stub each
S640/3 S-Clip sample holder with 3x S-Clip on 25mm Ø x 10mm JEOL SEM stub each



- S641** S-Clip sample holder with 1x S-Clip on 32mm Ø x 10mm JEOL SEM stub each
S641/2 S-Clip sample holder with 2x S-Clip on 32mm Ø x 10mm JEOL SEM stub each
S641/3 S-Clip sample holder with 3x S-Clip on 32mm Ø x 10mm JEOL SEM stub each



- S642** S-Clip sample holder with 1x S-Clip on 50mm Ø x 10mm JEOL SEM stub each
S642/2 S-Clip sample holder with 2x S-Clip on 50mm Ø x 10mm JEOL SEM stub each
S642/3 S-Clip sample holder with 3x S-Clip on 50mm Ø x 10mm JEOL SEM stub each
S642/4 S-Clip sample holder with 4x S-Clip on 50mm Ø x 10mm JEOL SEM stub each
S646 Swivel mount sample holder with 1 clip on 15mm Ø plate on 12.2mm Ø JEOL stub each



S-Clips on 45° & 90° JEOL Stubs

- S643** S-Clip sample holder with 1x S-Clip on 45° x 25mm Ø JEOL stub each
S644 S-Clip sample holder with 2x S-Clips at 45° & 90° on 25mm Ø JEOL stub each
S645 S-Clip sample holder with 2x S-Clips double 90° on 25mm Ø JEOL stub each



Stub Gripper Tweezers

The EM-Tec SEM stub tweezers securely grip SEM stubs and mounts to avoid touching them by hand to eliminate contamination issues. They are made from *anti-magnetic stainless steel* and are clean room compatible. They are excellent quality at an affordable price **and are available for:**

- All **grooved pin stubs** with 12.7, 19, 25.4 and 32mm head diameters (45° handle angle)
T600 anti-magnetic S/S tweezers for grooved pin stubs 12.7mm Ø 120mm long each
T601 anti-magnetic S/S tweezers for grooved pin stubs 19mm Ø 120mm long each
T602 anti-magnetic S/S tweezers for grooved pin stubs 25.4mm Ø 120mm long each
T603 anti-magnetic S/S tweezers for grooved pin stubs 32mm Ø 115mm long each
All **JEOL cylinder stubs** with 9.5, 12.2, 25.4 and 32mm head diameters (30° handle angle)
T604 anti-mag S/S grippers for 9.5mm Ø JEOL cylinder stubs 114mm long each
T605 anti-mag S/S grippers for 12.2mm Ø JEOL cylinder stubs 120mm long each
T606 anti-mag S/S grippers for 15mm Ø JEOL cylinder stubs 120mm long each
T607 anti-mag S/S grippers for 25mm Ø JEOL cylinder stubs 115mm long each
T608 anti-mag S/S grippers for 32mm Ø JEOL cylinder stubs 115mm long each
All **Hitachi cylinder stubs** with 15, 25 and 32mm head diameters (30° handle angle)
T609 anti-mag S/S grippers for 15mm Ø Hitachi & ISI cylinder stubs 120mm long each
T610 anti-mag S/S grippers for 25mm Ø Hitachi & ISI cylinder stubs 120mm long each
T611 anti-mag S/S grippers for 32mm Ø Hitachi & ISI cylinder stubs 120mm long each



SEM Sample Stub Adapters

Em-Tec SEM stub adapters enable the use of all common types of SEM stubs or mounts in your SEM. The advantages are:

- sample mounting independent of SEM platform
- time saved with no need to re-mount samples
- use of calibration and resolution standards mounted on different stubs
- no need to risk sample integrity
- enables collaborative investigation of samples

There are basically 5 common types of SEM sample stubs:

- Standard pin stubs with standard 9.5mm long pin used on FEI, Philips, Tescan, Phenom, Aspex, RJ Lee, Cambridge Instruments, Leica, Cam-Scan, ETEC and Novascan SEMs and SEM/FIB systems
- Zeiss pin stubs with short 6mm pin for Zeiss and LEO SEMs, CrossBeams and SEM/FIB systems
- Plain cylinder stubs for JEOL SEMs and SEM/FIB systems
- Hitachi cylinder stubs with M4 threaded base for Hitachi SEMs and FIBs
- Plain cylinder stubs for ISI, ABT, Topcon SEMs

For each of the above type mentioned SEM stubs there are EM-Tec SEM stub adapters available. The stub adapters are essentially made with the base of one type of an SEM stub and a top compatible with another type of SEM sample stub. All adaptors are all constructed from vacuum grade aluminium and made to original manufacturers specifications. The Hitachi stub extensions are made from self-lubricating brass with aluminium locking ring. Stub adapters are available as:

- Pin stub adapters for using other SEM stubs in pin type SEMs such as FEI, Philips, Tescan, Phenom, Aspex, Cambridge Instruments, Leica, etc. These can be used in Amray systems as well.
- Short pin stub adapters for using other SEM stubs in Zeiss and LEO SEMs
- JEOL stub adapters for using other pin stubs and Hitachi stubs in JEOL SEMs
- Hitachi M4 stub adapters for using pin stubs and JEOL stubs in Hitachi SEMs
- Other SEM stub adapters for less common SEMs such as ISI/ABT/Topcon and Agilent/Keysight
- Metal slide adapter to accommodate pin stubs on reflected light microscopes

For labs with multiple SEM platforms or for those who are regularly using different brands of SEMs, we offer the EM-Tec universal SEM stub adapter set. This universal SEM stub adapter set includes pin stub adapters, JEOL stub adapters (up to 25mm) and Hitachi stub adapters, all both ways. If you can't find the SEM stub or mount adapter you are looking for, please contact us. We might be able to offer a different solution or can manufacture custom SEM stub adapters.

Pin stub adapters for using different SEM stubs in pin type SEMs such as FEI, Philips, Tescan, Phenom, Aspex, Cambridge Instruments, Leica, etc.

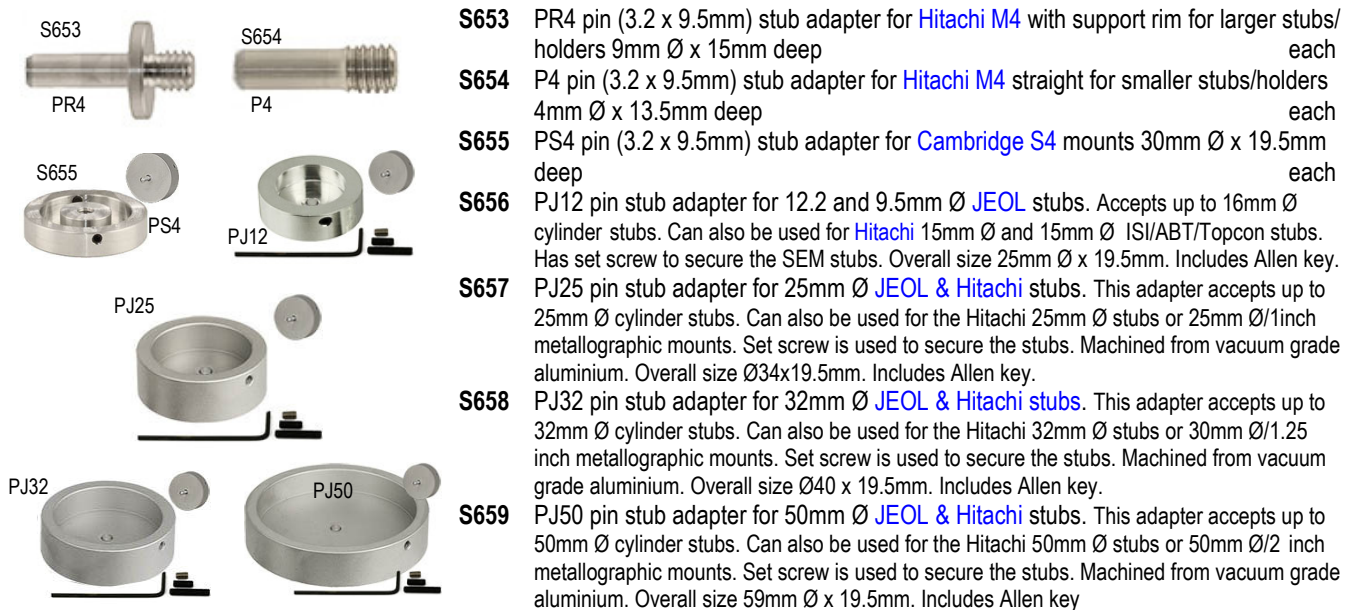

Zeiss short pin stub adapters for using different SEM stubs in Zeiss and LEO SEMs.
Pin stub adapters with the longer pin can be easily modified for use on Zeiss & LEO SEMs.

S647 ZR4 Zeiss pin stub adapter for **Hitachi M4** with support rim. Suitable for larger SEM stubs and larger SEM holders with M4 thread. Used on Zeiss and LEO SEMs. Pin is standard **3.2mm Ø and 6mm** long. The support rim has a 9mm Ø to give extra stability for larger SEM stubs and holders. Machined from vacuum grade aluminium. Overall size is 9mm Ø x11.5mm.



S648 Z4 Zeiss pin stub adapter to **Hitachi M4** for smaller SEM stubs and SEM holders with M4 thread. Used on Zeiss and LEO SEMs. Pin is standard 3.2mm diameter and 6mm long. Small design where the head of the adapter fits in the M4 thread. Machined from vacuum grade aluminium. Overall size is 4mm Ø x10mm.

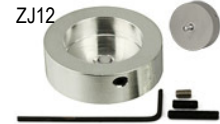

S649 ZJ12 Zeiss pin stub adapter for 12.2mm and 9.5mm Ø **JEOL** stubs. This stub adapter accepts up to 16mm Ø cylinder stubs. Can also be used for the **Hitachi** and **ISI/ABT/Topcon** 15mm Ø stubs. Set screw is used to secure the stubs. Machined from vacuum grade aluminium. Overall size Ø25x16mm. Includes Allen key.



S650 ZJ25 Zeiss pin stub adapter for 25mm Ø **JEOL** stubs. This stub adapter accepts up to 25mm Ø cylinder stubs. Can also be used for the **Hitachi** 25mm/1" Ø stubs or 25mm Ø/1" metallographic mounts.. Set screw is used to secure the stubs. Machined from vacuum grade aluminium. Overall size Ø34x16mm. Includes Allen key.



S651 ZJ32 Zeiss pin stub adapter for 32mm Ø **JEOL** stubs. This stub adapter accepts up to 32mm Ø cylinder stubs. Can also be used for the **Hitachi** 32mm/1" Ø stubs or 30mm Ø/1.25" metallographic mounts.. Set screw is used to secure the stubs. Machined from vacuum grade aluminium. Overall size Ø34x16mm. Includes Allen key.



S652 ZJ50 Zeiss pin stub adapter for 50mm Ø **JEOL** stubs. This stub adapter accepts up to 50mm Ø cylinder stubs. Can also be used for the 50 mm/2" Ø stubs or 30mm Ø/2" metallographic mounts.. Set screw is used to secure the stubs. Machined from vacuum grade aluminium. Overall size Ø34x16mm. Includes Allen key

Other Pin Stub Adapters

These adapters allow JEOL, ISI/ABT and Hitachi users to accommodate the standard pin stubs of the European and American manufacturers. The conversion cylinder contains a clip to hold the pin stub.

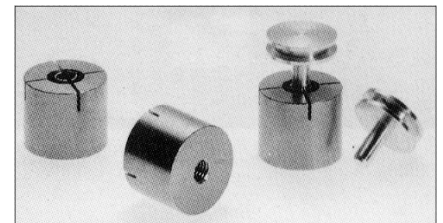

- S367** Converter for JEOL, 10mm Ø cylinder
- S367/1** Converter for JEOL, 12.5mm Ø cylinder
- S367/2** Converter for ISI/ABT, 15mm Ø cylinder
- S367/3** Converter for Hitachi, 15mm Ø cylinder with M4 internal thread

Gatan 3View sample pin stubs, tweezers and storage box

- G311** Gatan 3View system SEM pin stubs with standard 1.4mm Ø flat, 2mm Ø pin x12.5mm H, aluminium pack of 10
- G311/1** Gatan 3View system SEM pin stubs with standard 1.4mm Ø flat, 2mm Ø pin x12.5mm H, aluminium pack of 50
- G213** Gatan 3View system SEM pin stubs with large 2.4mm Ø flat, 2mm Ø pin x12.5mm H, aluminium pack of 10
- G312/1** Gatan 3View system SEM pin stubs with large 2.4mm Ø flat, 2mm Ø pin x12.5mm H, aluminium pack of 50
- T612** Gatan 3View stub handling tweezers, 118mm, anti-magnetic S/S each



B581 PS28 storage box for 28 Gatan 3View pin stubs each

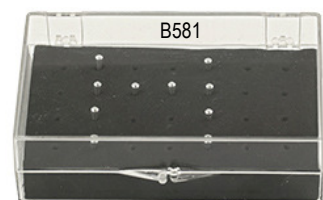

SEM Multiple Stub Holders

Our multiple pin stub holders are an efficient and cost-effective way to load multiple pin stubs with specimens in the SEM. Saves time, allows multi sample processing or quick comparison between samples. Intended for holding the standard 12.7mm (1/2") pin stubs, although the larger 25.4mm (1") pin stubs can be used on the holders for 6 pin stubs or more. All the positions on the holders for 6 pin stubs or more are **numbered** for easy identification and stubs are securely held with small M3 stainless steel set screws for the multi pin stub holders up to 12 pin stubs; an Allen key is included. On the 29 and 49 multi pin stub holders, the pin stubs are held with an integrated stainless steel spring. The 6 and 8 multi pin holders comprise engraved crossed lines to assist with directional navigation. They are all made from vacuum grade aluminium and have undergone a final cleaning step which results in a satin surface finish. Available with **standard pin** to fit FEI, Philips, Tescan, Phenom, Aspex, RJE, AmRay, Cambridge Instruments, Leica, CamScan, Aspex, ETEC and Novascan SEMs.

M4 threaded hole compatible with Hitachi SEMs, FESEMs and table top SEMs and **32mm JEOL SEM stub format** compatible with 32mm stub holders on JEOL SEMs. Additionally there are two **45° degrees pre-tilt multi-pin holders** available:

SEM Multi Pin Stub Holders on Standard Pin Base



Flat - Pin stubs 12.7 & 25.4mm Ø



- S662/4** P4 multi pin stub holder for 4 pin stubs, 31.5 mm Ø x 10.5mm, std pin each
S662/6 P6 multi pin stub holder for 6 pin stubs, 43mm Ø x 10.5mm, std pin each
S662/8 P8 multi pin stub holder for 8 pin stubs, 50mm Ø x 10.5mm, std pin each
S662/12 P12 multi pin stub holder for 12 pin stubs, 62mm Ø x 10.5mm, std pin each
S662/29 P29 multi pin stub holder for 29 pin stubs, 90mm Ø x 7mm, std pin each
S662/49 P49 multi pin stub holder for 49 pin stubs, 117mm Ø x 7mm, std pin each

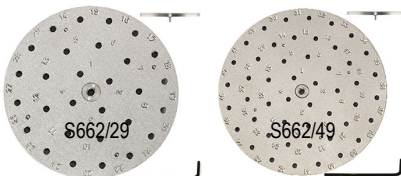

S663 P7 multi pin stub holder for 7 pin stubs 25.4mm Ø, 78mm Ø x 15mm, std pin each
 (No image)

Angled



- S664/3** P3/45 multi pin stub holder 45° for 3 pin stubs, 25mm Ø x 14mm, std pin each
S664/6 P6/45 multi pin stub holder 45° for 6 pin stubs, 35mm Ø x 14mm, std pin each

SEM Multiple Pin Stub Holders on M4 Hitachi Base



Flat - Pin stubs 12.7 & 25.4mm Ø



- S665/4** P4 multi pin stub holder for 4 pin stubs on M4 base 31mm Ø x 10.5mm each
S665/6 P6 multi pin stub holder for 6 pin stubs on M4 base 43mm Ø x 10.5mm each
S665/8 P8 multi pin stub holder for 8 pin stubs on M4 base 50mm Ø x 10.5mm each
S665/12 P12 multi pin stub holder for 12 pin stubs on M4 base 62mm Ø x 10.5mm each
S665/29 P29 multi pin stub holder for 29 pin stubs on M4 base 90mm Ø x 7mm each
S665/49 P49 multi pin stub holder for 49 pin stubs on M4 base 117mm Ø x 7mm each

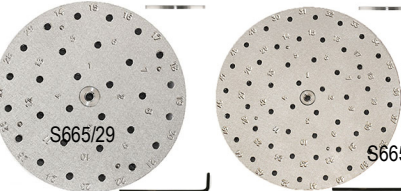

S666/7 P7 multi pin stub holder for 7 x 25.4mm Ø pin stubs, 78mm Ø 15mm M4 base each

Angled



- S667/3** P3/45° multi pin stub holder for 3 pin stubs, 25mm Ø x 14mm M4 base each
S667/6 P6/45° multi pin stub holder for 6 pin stubs, 35mm Ø x 14mm M4 base each

S668 Flat multi pin holder for 4 pin stubs 31.5mm Ø x 10.5mm on JEOL base each



Multiple Stub Holders for M4 Hitachi Stubs

Our multiple stub holders are an economical and simple way to load multiple Hitachi sample stubs with specimens in the SEM. Using multiple stub holders saves time, allows multi sample processing or allows quick comparison of samples. The horizontal multi stub holders are based on the 25mm Ø x 6mm x M4 and the 50mm Ø x 6mm x M4 Hitachi stubs to hold multiple stubs on M4 screws. The 45° multiple holders allow for a 45° pre-tilt which is beneficial for table top SEMs w/o a stage tilt or to quickly image under 45° w/o having to tilt the SEM stage. 45° tilted imaging tends to give a higher SE signal and reveals more of the topography of the specimen surface. The 45° multi stub holders are offered in two versions:

- Fixed M4 threaded screws to hold the Hitachi stubs
- Adjustable rotation M4 threaded screws for individual rotation of the Hitachi stubs to optimize viewing angle for the sample area

Flat

- S669** Multi stub holder for 3x15mm Ø M4 stubs, 25mm Øx6mm, 3.2mm Ø stage pin each
S670 Multi stub holder for 3x15mm Ø M4 stubs, 25mm Øx6mm with M4 thread each
S671 Multi stub holder for 3x25mm Ø M4 stubs, 50mm Øx6mm, 3.2mm Ø stage pin each
S672 Multi stub holder for 3x25mm Ø M4 stubs, 50mm Øx6mm with M4 thread each
S669/6 Multi stub holder for 6x15mm Ø M4 stubs, 50mm Øx6mm, 3.2mm Ø stage pin each
S670/6 Multi stub holder for 6x15mm Ø M4 stubs, 50mm Øx6mm with M4 thread each

Angled 45°

- S673** Multi holder 45° for 3x15mm Ø M4 stubs 25mm Ø x14mm, 3.2mm Ø stage pin each
S674 Multi stub holder for 3x15mm Ø M4 stubs, 25mm Øx14mm with M4 thread each
S673/6 Multi stub holder for 6x15mm Ø M4 stubs, 50mm Øx6mm, 3.2mm Ø stage pin each
S674/6 Multi stub holder for 6x15mm Ø M4 stubs, 50mm Øx6mm, with M4 thread each

45° Angled Stub Holders with Individual Rotation (IR)

Each M4 stub can be individually rotated to optimise the viewing angle for the sample area

- S675** Multi holder 45° IR for 3x15mm Ø M4 stubs, 25mm Øx14mm, std stage pin each
S676 Multi holder 45° IR for 3x15mm Ø M4 stubs, 25mm Øx14mm, M4 thread each
S675/6 Multi holder 45° IR for 6x15mm Ø M4 stubs, 35mm Øx14mm, std stage pin each
S676/6 Multi holder 45° IR for 6x15mm Ø M4 stubs, 35mm Øx14mm, M4 thread each

JEOL Multiple Cylinder Stub Holders

- S677** Multi stub holder for 4x 9.5mm Ø cylinder stubs 31.5mm Ø x 10mm deep each
S678 Multi stub holder for 3x 12.2mm Ø cylinder stubs 31.5mm Ø x 10mm deep each

JEOL multiple cylinder stub holders on standard (3.2mm Ø) pin base

- S679** Multi stub holder for 4x 9.5mm Ø cylinder stubs 31.5mm Ø x 10mm on std pin each
S680 Multi stub holder for 3x 12.2mm Ø cylinder stubs 31.5mm Ø x 10mm on std pin each
S681 Multi stub holder for 6x 12.2mm Ø cylinder stubs 50mm Ø x 10mm on std pin each

JEOL multiple cylinder stub holders on Hitachi M4 base

- S682** Multi stub holder for 4x 9.5mm Ø cylinder stubs 31.5mm Ø x 10mm M4 each
S683 Multi stub holder for 3x 12.2mm Ø cylinder stubs 31.5mm Ø x 10mm M4 each
S684 Multi stub holder for 6x 12.2mm Ø cylinder stubs 50mm Ø x 10mm M4 each



Gold Series SEM Sample Holders and Pin Stub Adapters

Our gold series SEM sample holders comprise a selection of compact holders, all made from brass and plated with 1µm of pure gold. Brass is chosen for greater strength and is fully non-magnetic. The gold plating assists in keeping the sample holders clean during handling. The superior chemical resistance of the gold plating facilitates the use of cleaning solutions or plasma cleaning. Clean sample holder surfaces will also greatly reduce contamination transfer to the samples. Intended for use with table top SEMs, laboratory grade SEMs and FESEMs.



Rectangular type bulk sample holder with pin (or M4) and two side brackets for sample thickness up to 16mm. Made from brass, 1µm thick gold plated. Ideal for smaller samples and smaller SEMs. Provided with 4 set screws.

S690 Bulk sample holder for up 16mm, gold plated brass, [Pin mount](#) each

S691 Bulk sample holder for up 16mm, gold plated brass, [M4 mount](#) each



Mini pin stub tube/needle clamp. Capacity up to 2mm Ø, the needle is secured with a small set screw. This holder is ideal for probes, needles, wire and thin tubes. Holder size is 6mm Ø x4mm. Made from brass and plated with 1µm of pure gold.

S692 Needle/tube sample holder for up to 2 mm Ø, gold plated brass, pin each



A swivel vice which covers a full 180° angle and can also be rotated with the stub. This is the ultimate holder for imaging cross sections at any desired angle. The swivel head size without clamping screws is only 16 x16 x 14mm. The sample is clamped with the two knurled clamping screws; the swivel head can be locked in place with the tilt clamping screw. Made from brass and plated with 1µm of pure gold.

S693 Swivel head sample holder for up 10mm samples, gold plated brass, pin each



Round type bulk sample holder with three brackets for round and awkwardly shaped samples up to 20mm Ø. Made from brass, 1µm thick gold plated. Ideal for smaller samples and smaller SEMs. Provided with 6 set screws.

S694 Bulk sample holder for up to 20mm Ø, gilded brass, [Pin mount](#) each

S695 Bulk sample holder for up to 20mm Ø, gilded brass, [M4 mount](#) each



Lightweight, spider like holder for awkwardly shaped samples up to 25mm Ø. Samples are supported by the three threaded legs and clamped by the flanges on the clamping nuts. Made from brass and plated with 1µm of pure gold.

S696 Spider type bulk sample holder for up to 25mm Ø, gold plated brass, [pin](#) each



Lightweight, spider like holder for awkwardly shaped samples up to 45mm Ø. Samples are supported by the three threaded legs and clamped by the flanges on the clamping nuts. Made from brass and plated with 1µm of pure gold.

S697 Spider type bulk sample holder for up to 45mm Ø, gold plated brass, pin each



Compact Zeiss pin stub adapter with M4 threaded head to convert stubs and sample holders with an M4 threaded hole to a Zeiss pin stub. Pin is 3.2mm diameter and 6mm long. Made from brass and plated with 1µm of pure gold.

S698 Compact Zeiss pin stub adapter with M4 thread, Au plated brass, short Zeiss pin each



Compact standard pin stub adapter with M4 threaded head to convert stubs and samples holders with an M4 threaded hole to a *standard pin stub*. Pin is 3.2mm diameter and 9.5mm long. Made from brass and plated with 1µm of pure gold.

S699 Compact standard pin stub adapter with M4 thread, gold plated brass, pin each

Universal SEM Sample Holder and SEM Stub Adapter Kit

The universal SEM sample holder and SEM stub adapter kit has been created to hold a wide variety of SEM samples up to 42mm. The samples can be flat, round, block or awkwardly shaped. Also included is a useful selection of SEM stub adapters which enables the kit to be used on virtually any SEM. Fully compatible with FEI/Philips, JEOL, Hitachi, Tescan, Zeiss/LEO and other brands of SEMs.

Ideally suited for:

- multi-user environments
- labs with different brands of SEMs
- labs with a large and changing variety of samples
- service labs to cope with different sample stubs
- portability between SEM platforms

The selection of SEM sample holders all include an M4 threaded hole. Fully compatible with the SEM stub adapters provided in this universal sample holder kit and with Hitachi SEMs.

Included SEM stub adapters in the kit are:

- pin stub adapters for FEI/Philips, Zeiss/LEO, Tescan, Amray
- a 12.2mm JEOL stub adapter with M4 screw
- a 12.2mm JEOL stub adapter for pin stubs
- Multi pin holder doubles as pin stub adapter for Hitachi SEMs.

List of included items: Compact vice clamp 0.22mm, Mini vice clamp 0.6mm, Multi holder for 4 pin stubs, Universal spring loaded vice holder up to 42mm, Bulk sample holder up to 32mm Ø, 3x S clip on 25mm Ø M4 stub, 2x S clip on 45/90° 25mm Ø M4 stub, Short pin stub adaptor with rim to M4, Std pin stub adaptor with rim to M4, Long pin stub adaptor with rim to M4, JEOL 12.2mm Ø stub to pin, JEOL 12.2mm Ø stub to M4.

The complete kit is presented in a high quality wooden box with all the SEM sample holder and adapters neatly arranged in a hard plastic insert. This kit can also be used to convert SEM sample stubs up to 32mm diameter to fit other SEM brands.

S475 Universal SEM sample holder and stub adapter kit in wooden box, complete with insert.



Details overleaf

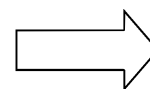

Vacu-Storr High Vacuum SEM Sample Storage Protect Sensitive Samples & Calibration Standards

Dimensions & Capacities of Vacu-Storr

Container	Vacu-Store Small	Vacu-Storr Medium	Vacu-Storr Large	Vacu-Storr X-large
Inside diameter	41mm	76mm	76mm	140mm
Outside diameter	54mm	85mm	90mm	153mm
Volume	40cc	320cc	680cc	3800cc
Top opening diameter	40mm	75mm	75mm	75mm
Inside useable height	30mm	71mm	150mm	305mm
Total height	95mm	140mm	190mm	350mm



EM-Storr Vacuum Storage & Shipping Container for FIB, SEM, TEM, & Calibration Specimens

The EM-Storr vacuum sample storage container has been specifically developed to store and protect SEM/FIB/TEM samples and calibration standards under vacuum. It protects valuable samples from air, moisture and dust. The superior EM-Storr vacuum container is constructed to the highest standards using high vacuum compatible materials, vacuum grade aluminium, a hardened safety glass lid, NBR O-ring and an all metal high vacuum valve with PTFE shaft seal. The outside of the aluminium container is hard anodised for protection. To reduce outgassing and to hold vacuum for extended periods, the inside surface is machined vacuum grade aluminium with a hardened glass lid. The EM-Storr vacuum desiccator is capable of reaching vacuum in the 10^{-4} mbar range. The vacuum connection for pump-down is a 6mm (1/4") barbed hose fitting – compatible with 6mm thick wall silicon vacuum hose. The EM-Storr vacuum containers are stackable and the octagonal design is optimised for handling, strength and weight.

Features

- Protects oxygen sensitive and/or moisture sensitive samples
- Protects samples and calibration standards against contamination
- Designed for SEM pin stubs and/or Hitachi M4 stubs
- Ideal for storing and transporting sensitive samples
- Clear hardened glass lid provides excellent vacuum seal
- Easy sample location through clear glass lid
- Sturdy, space-saving stackable and octagonal design

V106 EM-Storr vacuum sample storage container for 19 x 12.7mm Ø pin stubs

V107 EM-Storr vacuum sample storage container for 19 x 15mm Ø Hitachi stubs

V108 EM-Storr vacuum sample storage container for 60 TEM grids

V109 EM-Storr vacuum sample storage container for 100 FIB lift-out grids in box

V110 Replacement glass lid for EM-Storr vacuum sample container, 100mm Ø x 10mm



Vacu-Storr High Vacuum EM Sample Storage Containers

Protect Sensitive Samples & Calibration Standards

The Vacu-Storr high vacuum glass storage container have been especially developed for protecting materials and samples which are sensitive to dust, moisture, oxygen or other gases found in the environment. The containers consists of a soda lime glass jar, nickel plated aluminium lid, Viton O-ring seal and a metal sealed high vacuum valve. The high vacuum valve has a 6mm (1/4") barbed hose fitting to connect the hose to a vacuum pump or vacuum pumping system. The Vacu-Storr desiccators are capable of reaching a vacuum level of 10^{-4} mbar and expect to have an estimated vacuum holding time of 5 years to 100mbar. There are 4 sizes available, all supplied with a protective plastic netting and a protective polymer coating on the outside to prevent damage.

- | | | |
|-------------|-----------------------|-----------------|
| V111 | Vacu-Storr Small | Capacity 40ml |
| V112 | Vacu-Storr Medium | Capacity 320ml |
| V113 | Vacu-Storr Large | Capacity 680ml |
| V114 | Vacu-Storr Xtra Large | Capacity 3800ml |

Wafer Holders for SEM

Compatible with wafers with or without a notch

These wafer holders are specially designed to hold semi-conductor wafers in sizes of 100mm, 150mm and 200mm diameter (4 inch, 6 inch and 8 inch). They are compatible with wafers with either a flat or with a notch. The unique locking slide is adjustable to cope with non-standard wafers.

Unique features:

- low profile, weight balanced support disc
- square cut-outs for wafer tweezers
- adjustable spring tension
- adjustable for non-standard wafers
- self lubricating locking slide
- compatible with either wafers with a notch or wafers with a flat
- compatible with our stage adapters for all SEM platforms

Available with:

Standard pin to fit on SEMs FEI, Philips, Zeiss, LEO, Leica, Tescan, Aspex, R J Lee, AmRay, Cambridge Instruments, CamScan, ETEC and Novascan.

M4 threaded hole; compatible with Hitachi SEMs, FESEMs and table top SEMs and with the our versatile SEM stage adapters.

W106 **Standard pin** Wafer Holder for 100mm Ø (4")
W106/1 **M4 threaded hole** Wafer Holder 100mm Ø (4")

Dimensions without pin 106mm Ø x 16mm

W107 **Standard pin** Wafer Holder for 150mm Ø (6")
W107/1 **M4 threaded hole** Wafer Holder 150mm Ø (6")

Dimensions without pin 156mm Ø x 16mm

W108 **Standard pin** Wafer Holder for 200mm Ø (8")
W108/1 **M4 threaded hole** Wafer Holder 200mm Ø (8")

Dimensions without pin 206mm Ø x 16mm

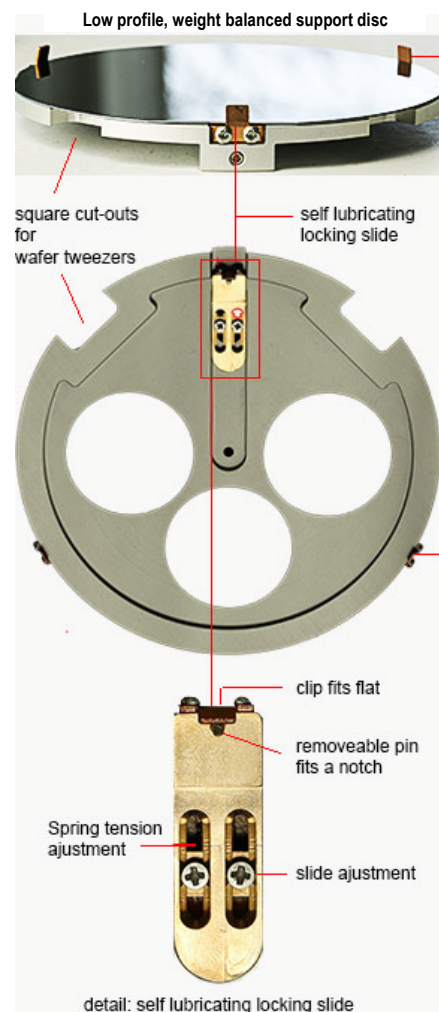

W106



W107



W108

Compact & Universal Vice Type SEM Sample Holders

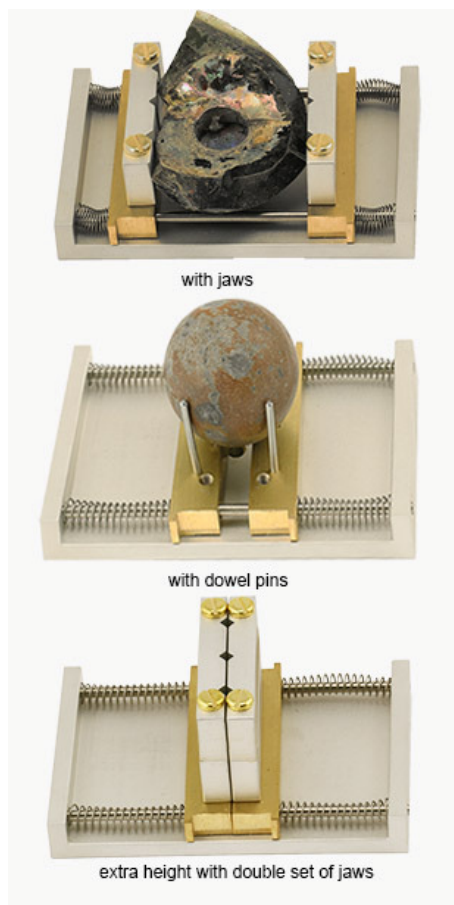

Vice type sample holders with a [standard pin](#) or [M4 threaded](#) hole are quick and easy to use holding the sample by clamping it between the moving jaws. They are especially useful when similar samples or a series of the same sample need to be examined. A vice clamps the sample and provides the rigidity needed for high resolution imaging and is a better alternative to adhesives or glue. All vice clamps are made from vacuum grade aluminium. Currently available items are:

- 1) Compact cost-effective vice sample holder for sample sizes up to 22mm using one fixed jaw and a spindle driven moving jaw. Can be used in both standard and table top SEMs. Brass spindle and stainless steel screws.
- 2) Single action spring-loaded vice for samples with a maximum clamping size of 12mm. The vice is opened by pushing the moving jaw with a push rod. The rod can be removed when the holder is loaded in the SEM. Dowel pins can be inserted in the fixed and moving jaws to increase the opening to a sample size up to 18mm diameter or to hold awkwardly shaped samples; 4 dowel pins are included. Stainless steel rods and springs.
- 3) Compact double action spring-loaded vice for samples with a maximum clamping size of 26mm. Due to the double sided spring, this vice acts as a centring vice. The jaws are opened by push rods which can be removed when the sample holder is loaded in the SEM. Dowel pins can be inserted in the jaws to increase the opening to a sample size up to 34mm diameter or to hold irregular shaped samples; 4 dowel pins are included. Stainless steel rods and springs.
- 4) Universal double sided spring-loaded larger vice for samples with a maximum size of 42mm. Different types of jaws can be mounted on this universal vice. Opens by pulling the jaws. Dowel pins can be inserted in the brass slider to extend the opening size and to hold awkwardly shaped samples. With the dowel pins a disc of up 50mm diameter can be held; 4 dowel pins are included. Includes triple grooved/smooth vice jaws. Additional optionally available vice jaws are:

Jaw with a single 120° large groove for round samples

Standard jaw with triple grooved/smooth side. vice jaws can be stacked to increase the jaw height from 12 to 24mm. Brass sliders and stainless steel rods and springs.

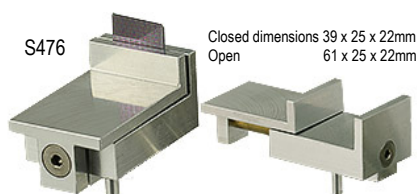

S476 Pin Vice clamp - includes a 2.5mm Allen key to operate the spindle screw for opening and closing this compact clamp for samples up to **22mm Ø**. Very thin samples can be securely held in this holder. For delicate samples, consider lining the jaws with conductive soft material (S480).

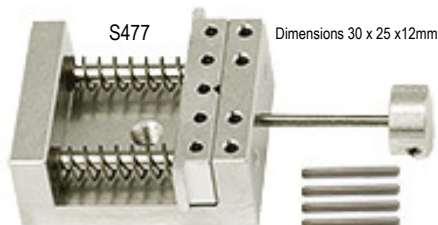

S476/1 As S476 but with [M4](#) threaded hole

S477 Pin single action spring-loaded vice clamp includes one removable push rod and four dowel pins which fit into the top of the jaws. The maximum clamping capacity between the vice jaws is **12mm**. Clamping size increases to **18mm** with dowel pins.

S477/1 As S477 but with [M4](#) threaded hole

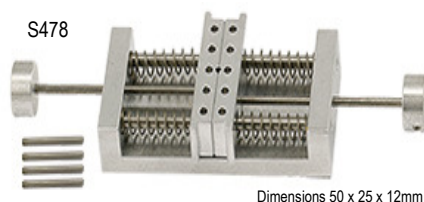

S478 Pin base dual action spring-loaded vice clamp includes two removable push rods and four dowel pins which fit into the top of the jaws. The maximum clamping capacity between the vice jaws is **26mm**. Clamping size increases to **34mm** with dowel pins.

S478/1 As S478 with [M4](#) threaded hole

S479 Pin base dual action spring-loaded vice clamp includes two removable push rods and four dowel pins which fit into the top of the jaws. The maximum clamping capacity between the jaws is **42mm**. The aluminium vice plates have reversible jaws with a smooth side and a side with three small grooves. The grooves are more suitable for small round samples or to hold samples with a rough sides. Maximum sample capacity between dowel pins is **50mm**.

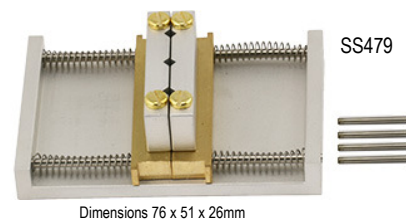

S479/1 As S479 with **M4** threaded hole

S479/T Standard triple groove/smooth vice jaw, 12 x 40 x 6mm, each



S479/S Single large groove/smooth vice jaw, 12 x 40 x 6mm, each



Conductive soft jaw lining kit for vice type SEM sample holders Comprises a conductive neoprene rubber sheet with a conductive adhesive layer on one side. It is intended to hold more delicate samples and to prevent damage to sensitive surfaces. The conductive medium soft rubber provides both a soft grip and a path to earth. This kit has been designed for use on all vice type holders. It comes as one piece and can be cut to size as required. After use it can be easily replaced or removed from the vice jaws (use acetone/isopropanol for cleaning). Supplied as a sheet which holds enough material to cut 5-6 sets of soft jaw linings.



S480 Conductive soft jaw lining kit for vice type SEM sample holders, 50x120mm sheet

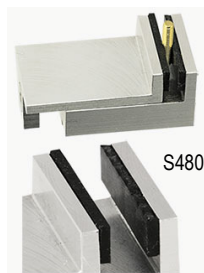

Large Versatile Vice Clamp Sample Holders

These holders are large vice clamps with movable jaws and can accommodate large, heavy or multiple samples. They are designed for SEMs with large sample stages. The holders consist of a base plate with two parallel rows of holes to position the vice jaws at 10mm intervals for optimum sample compatibility. Made from vacuum grade aluminium with brass mounting screws and steel clamping screws. The sample can be adequately held using the clamping screws. Two sets of 3 screws with 10mm and 16mm length are provided with each vice clamp plate. The holders are freely configurable. There are **two** models to fit various sample sizes:

- V80 versatile vice clamp holder - for samples up to 80mm
- V120 versatile vice clamp holder – for samples up to 120mm.
Additional jaws can be added to mount multiple samples in the same holder. Currently, there are three types of vice clamps available:
 - standard vice clamp plates with 12mm height
 - optional grooved vice clamp plates with 16mm height
 - height extension clamp plates with 12mm height. Mount one or two additional extension clamps to increase the height to 24mm or even 36mm. The standard and height extension vice clamp plates can be mounted either way to optimise the height of the set screws.

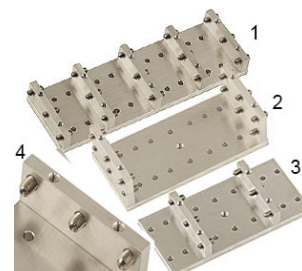

S700 Versatile vice clamp sample holder for up to 80mm **pin stub**

S701 Versatile vice clamp sample holder for up to 80mm **M4 threaded hole**

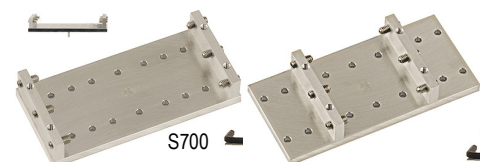

S702 Versatile vice clamp sample holder for up to 120mm **pin stub**

S703 Versatile vice clamp sample holder for up to 120mm **M4 threaded hole**



Additional adjustable clamps next page

With extra clamp plates (not included)



S704

Clamp plates attached in standard position with set screws in a higher location

Clamp plates attached upside down with set screws in a lower location

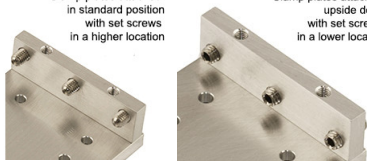

Additional Clamping Jaws for Large Versatile Specimen Clamps

S704 VC12 standard vice jaw plate 12 x 44 x 5mm incl. set screws.

The vice jaw plates can be mounted either way to optimise the height of the clamping screws. When the plates are attached in the standard position, the clamping screws are in a higher position. Attach the plates upside down, and the clamping screw will be in a lower position.

Multiple vice clamps can be used on one vice base plate. The jaw plates can be mounted on the base plate at 10mm intervals to maximise sample size compatibility.

S705 VC16 grooved jaw plate 16 x 44 x 5mm incl. set screws

The grooved vice clamping plates can be mounted either way to optimise the height of the clamping screws. When the grooved vice clamping plates are attached in the standard position, the clamping screws are in a higher position. Attach the grooved clamping plates upside down and the clamping screw will be in a lower position.

Multiple vice clamping plates can be used on one vice base plate. The vice clamping plates can be mounted on the base plate in 10mm intervals to maximise sample size.

S706 VH12 height extension clamping plate for VC12 with mounting screws, incl. set screws

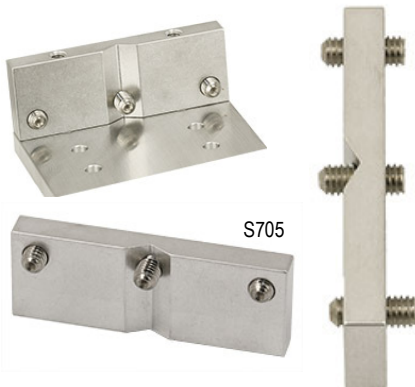

S705



S706



Shown with base plate (not included)

Height extension vice clamp with 12mm height and 3 set screws. Can be mounted on top of the standard or grooved vice clamps to increase the clamp height to 24 or even 30mm. The vice clamps can be mounted either way to optimize the height of the set screws.

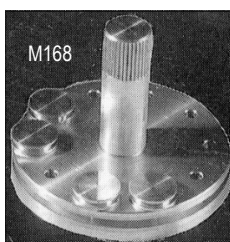

M168

Preparation Stand for SEM Specimens

A cylindrical aluminium block for holding up to 10 specimen mounts for attachment of, or manipulation of samples. A rubber 'O' ring retains the mounts.

M168 Mounting block - pin stubs each

M169 Mounting block - 10mm cylinders each



T137

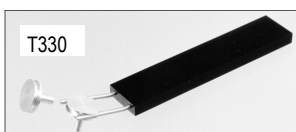

T330

Tweezers for Stubs

Tweezers specially designed for handling 1/2" specimen stubs commonly used in SEM.

T137 Tweezer for 1/2" stubs each

T330 SEM stub handling tool - A simple robust tool to fit 12.5mm pin stubs as an alternative to T137 suitably angled to allow convenient handling of the stubs in confined areas. The beryllium copper prongs allow a firm grip to be repeatedly achieved without loss of spring tension.

Tweezer for Hitachi Stubs

T329 Special tweezer for handling 15mm Ø Hitachi stubs each

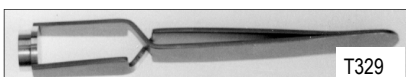

T329

SEM, TEM, STM Supplies 10

Large Capacity Stub Boxes

Two high capacity **wooden boxes** for storage of light sensitive specimens.

B585 Holds **176** standard 12.7mm Ø pin stubs or **40** x 25.4mm Ø stubs. Pin stubs up to 100mm can be stored in this box. Made from *clear coated beech and birch* with 2 brass plated hinges and clasps. Max. specimen height of 22mm. Dimensions 276 x 189 x 46mm.

B586 Holds **77** x 12.7mm Ø pin stubs or **20** x 25.4mm Ø stubs. Construction as BXXX but with single clasp. Dimensions 189 x 138 x 46mm.

Two high capacity **clear styrene** boxes.

B587 Holds **153** x 12.7mm Ø pin stubs or 40 x 25.4mm Ø stubs. Can store stubs up to 100mm Ø. Dimensions 274 x 160 57mm. Maximum specimen height 34.5mm

B588 Holds **28** x 12.7mm pin stubs. Can store stubs up to 50mm Ø. Maximum specimen height 13.5mm. Dimensions 120 x 84 x 36mm.



Storage Boxes for SEM Stubs

We offer a range of boxes that will accept specimen mounts in common use. They consist of a transparent plastic box with a *white plastic insert*. The specimen mounts are a push fit into the appropriate holes and do not shake loose during transportation. There is sufficient height above the specimen (approx. 12mm) to permit the storage of very thick mounted specimens. An identification label is enclosed to record specimens.

- | | | |
|-------------|--|------|
| B098 | Storage box for 8 x 1/2" pin type mounts | each |
| B157 | Storage box for 8 x 10mm Ø JEOL mounts | each |
| B099 | Storage box for 8 x 15mm Ø JEOL mounts | each |
| B158 | Storage box for 3 x 32mm dish type mounts | each |
| B576 | Storage box for up to 9 mounting stubs of either 1" (25mm) in diameter or a stub with 1/8" (3.2mm) diameter pin. Insert made from a <i>soft silicone base</i> with 9 holes each 1" (25mm) in diameter and 1/4" (6mm) deep. Overall measurements 4 3/4" L x 3 5/8" W x 1.2" H (12 x 9 x 3cm) | |

Wooden Box

- | | | |
|-------------|---|------|
| B097 | Storage box for 54 x 1/2" pin type mounts | each |
|-------------|---|------|

SEM-STOR Economical Storage

Sem-Stor is the answer to economical storage of SEM specimens. It is made from cardboard and has a fold-up insert that takes 8 specimen mounts of the 1/2" pin type. The front lip of the box is cut away for convenient observation and handling of stubs. Shipped flat, makes up into a 7 x 3.8 x 3.5cm high box.

- | | | |
|---------------|--|---------|
| B135 | Sem-Stor cardboard storage box for 1/2" mounts | each |
| B135/1 | Sem-Stor cardboard storage box for 1/2" mounts | per 100 |

Single Stub Storage Tubes

For storage or transportation. The SEM stub pin is a tight push fit inside the cap that is then placed in the clear acrylic tube. A secure and effective method for post or pocket.

- | | | |
|---------------|--|------------|
| T350 | Single SEM pin stub storage tube for 1/2" (12.5mm) stub | pack of 5 |
| T350/1 | Single SEM pin stub storage tube for 1/2" (12.5mm) stub | pack of 25 |
| B421 | White cardboard storage box for 10 T350 tubes | 1 |
| B422 | White cardboard storage box <i>with</i> 10 T350 tubes | 1 |
| T570 | Single SEM pin stub storage tube for stubs up to 38mm Ø | pack of 10 |
| T571 | Single SEM stub storage tube for Hitachi M4 up to 38mm Ø | pack of 10 |

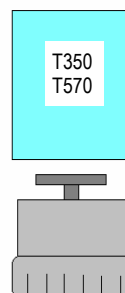

B421

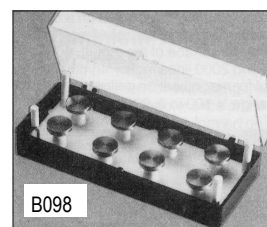

B098



B576

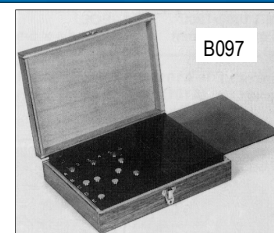

B097



B135

10 SEM, TEM, STM Supplies

SEM Specimen/Stub Adhesives

A listing of many different adhesive methods for attaching specimens to SEM mounts.



Colloidal Graphite

A suspension of pure, fine colloidal graphite in water or in isopropanol based solution. To form a conducting dry film of graphite on a variety of materials.

C107	Colloidal graphite - aqueous base	500g
C126	Colloidal graphite - isopropanol base	500g

Silver Paint

An air drying paint containing silver flakes. Dries to form a conducting film that is ideal for sample mounting.

S269	Silver paint	10g
S270	Silver paint	50g

Silver Paint Thinners

A thinner to reduce the thickness of our silver paint S066 to make thin conductive tracks on the specimen for microprobe work.

S271/1	Silver Paint Thinners	25ml
S271	Silver paint thinners	100ml

Silver Epoxy Adhesive

A two part silver filled epoxy adhesive providing a conducting joint and bond. *Silver content 70%*. Information sheet provided with each pack.

S055	Silver epoxy adhesive	pack of 10g
------	-----------------------	-------------

Conducting Carbon Cement (Leit-C)

A suspension of very fine carbon particles in a volatile carrier. Suitable for forming a conducting film bond between specimen or carbon disc to stub.

C198	Carbon cement (Leit-C)	30g
C198/1	Thinners for Leit-C	30ml

Leit-C Plast

A plasticine like material with low outgassing properties suitable for use in the high vacuum of the SEM. Leit-C Plast is a conductive material requiring no additional coating and is suitable for many applications in specimen preparation.

C199	Leit-C-Plast	15g
------	--------------	-----

Tempfix

A thermoplastic adhesive that when applied to a heated stub at approximately +40°C yields a sticky surface suitable for holding specimens. It dries quickly to a very smooth surface and remains stable under the SEM.

T328	Tempfix	set
------	---------	-----

Microstik

A clear adhesive for mounting small particles. Provides an ultrathin base when applied to the SEM specimen mount. Dries quickly and is non-conductive

M167	Microstik solution	14ml
------	--------------------	------

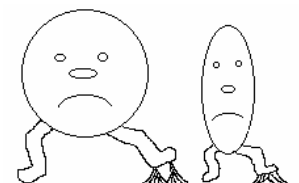
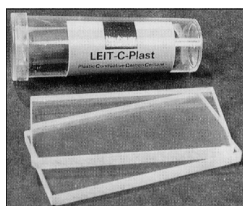

SEM, TEM, STM Supplies 10

Conducting Film Aerosol

A rapid method of spraying a conductive film onto SEM specimens such as pieces of biological tissue. Effects are not permanent so it is ideal for rapid examination in the SEM.

C212 Conducting film aerosol 397ml can

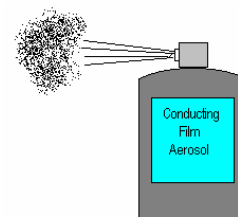

Carbon Discs

A range of discs 3mm thick with diameters of 12.5mm, 15mm or 25mm for mounting specimens in the SEM.

C304/10 Carbon discs 12.5mm Ø pack of 10 **C305** Carbon disc 15mm Ø
C305/10 Carbon discs 15mm Ø pack of 10 **C306** Carbon disc 25mm Ø
C306/10 Carbon discs 25mm Ø pack of 10

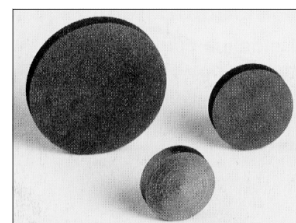

Conductive Carbon Adhesive Discs

For SEM stubs. An improvement on double sided tape. These new doubly adhesive carbon based discs ensure good electrical connection whilst retaining the benefits of a quick mounting method.

C263/N 9mm Ø pack of 100
C249/N 12mm Ø pack of 100
C252/N 25mm Ø pack of 51



Sulphur-Free Conductive Carbon Discs

Adhesive discs with low background for microanalysis

C272 Sulphur-free conductive carbon tabs 12mm Ø pack of 120



Double Sided Sticky Carbon Tape

Highly conductive tape for SEM and EDS applications. The double adhesive and conductive design permits quick mounting of samples without using liquid or colloidal adhesives. The tape is relatively solid and non-porous and does not absorb small samples. Thickness is 0.16mm.

C261 Carbon tape 8mm x 20m long each
C277 Carbon tape 12mm x 20m long each
C278 Carbon tape 50mm x 20m long each

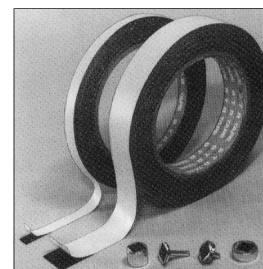

Conductive Carbon Adhesive Sheet

For SEM or EDS we have available double sided carbon sheet for eliminating background X-rays. When cut to size it is easy to place on SEM stubs and is contaminant free.

C206 Carbon conductive adhesive sheet 5 x 12cm pack of 10

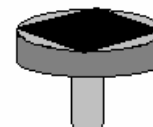

Sticky Tabs

Sticky tabs may be affixed to most types of stubs. Once affixed to the top of a stub simply remove the peel-off tab to leave a 1/2" (12.7mm) Ø layer of adhesive to which small specimens can be fixed, or impressions such as fingerprints can be made in the adhesive for examination. Non conducting and the strong silicone adhesive does not outgas in the vacuum. The adhesive can be removed with acetone.

T199 Sticky tabs pack of 100

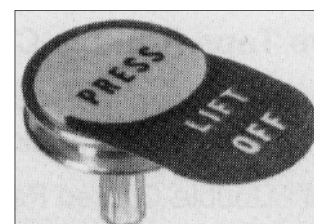

10 SEM, TEM, STM Supplies



Copper Tape

Copper strip with pressure sensitive adhesive backing. Ideal for static charging problems etc.

T188 Copper tape 12mm x 16m per roll

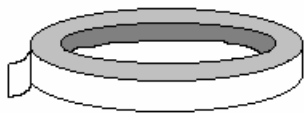

Aluminium Tape

Two sizes of aluminium strip with pressure sensitive adhesive backing. Ideal for conductive connections etc.

T189 Al tape 12mm x 55m x 0.09mm per roll

T189/1 As T189 but 0.13mm thick

T190 Al tape 25mm x 55m x 0.09mm per roll

T190/1 As T190 but 0.13mm thick

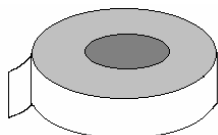

Magic Tape

This 3M tape is transparent when affixed to objects and makes amending and updating documents easy. It is ideal for making small labels being easy to type or write on and is invisible on photocopies.

T191 Magic tape 12mm x 66m

per roll

T523 Magic tape 25mm x 66m

per roll

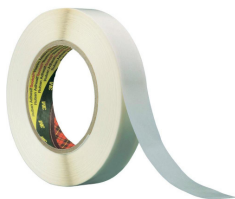

Double Sided Tape

A thin double sided sticky tape in two widths suitable for mounting specimens and for general SEM work.

T063 Double sided tape 12mm x 66m

per roll

T064 Double sided tape 38mm x 66m

per roll

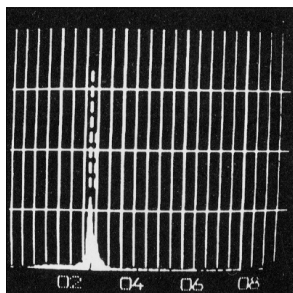

EDS spectrum of silver sheet S331

Silver Conducting Adhesive Sheet

Highly electrically conductive sheet 5 x 12 x 0.16cm thick suitable for cutting and sizing to samples for SEM.

- Little outgassing under vacuum
- Doesn't absorb or penetrate specimens

S331 Silver conductive sheet pack of 5

Silicon Chip Specimen Supports

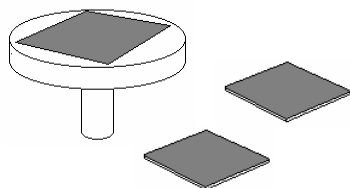

Si-chips are opaque, of low electrical resistance and have surface properties equal to glass. They are chemically inert and make good substrates for growing or mounting cells or ferritin particles. They are useful for determining resolution and contrast capabilities of the "in-the-lens" SEMs equipped with high brightness electron emitters. Si-chips are precleaned before packing

S332 4" (10cm) silicon wafer diced into approx. 270 chips 5 x 5mm

SEM, TEM, STM Supplies 10

AFM/STM/SPM Accessories

Highly Orientated Pyrolytic Graphite

H.O.P.G is widely used as a substrate for AFM/STM specimens. It can also be used as a calibration specimen.

G260 H.O.P.G.

piece approx. 10 x 10 x 2mm

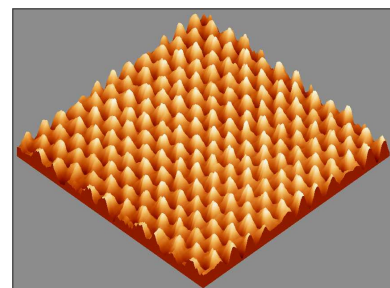

SPM Metal Specimen Discs

These high quality discs for SPM are manufactured with smooth edges and consistently flat surfaces.

D245 SPM specimen discs, 12mm Ø, pack of 50

D246 SPM specimen discs, 15mm Ø, pack of 50

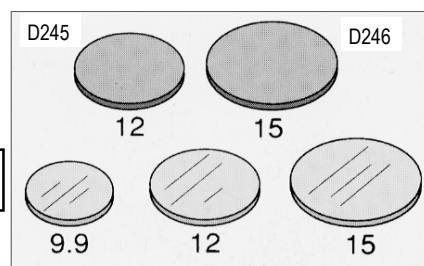

Mica Mounting Discs and Glass Coverslips

An alternative to metal discs for certain applications.

M406 Mica discs 9.9mm Ø, 0.2-0.22mm thick pack of 10

M407 Mica discs 14mm Ø, 0.1mm thick pack of 10

C302 Round glass coverslips, 12mm Ø, box of 100

C303 Round glass coverslips, 15mm Ø, box of 100

SPM Dispenser for Discs

An easy and clean way to store and dispense SPM discs. The plastic package containing the discs is inserted into the dispenser and a single disc can be dispensed with a simple turn of the cylinder. This can then be picked up using the disc gripper. The dispenser is suitable for 12 or 15mm Ø discs.

D247 SPM disc dispenser

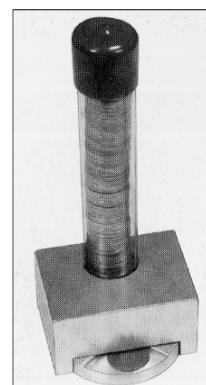

Disc Gripper

A gripper specially designed to pick up discs from a flat surface without damage due to the rubber coated tips.

G199/12 Gripper for 12mm Ø discs

G199/15 Gripper for 15mm Ø discs

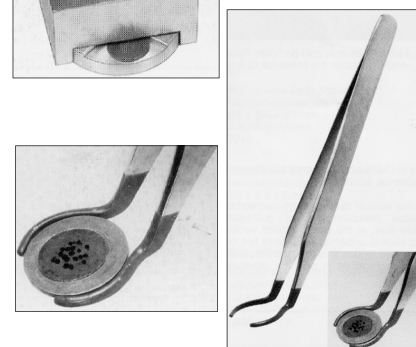

Disc Carrier/Storage

A practical and dust-free way to store 12mm and 15mm Ø discs. Discs are placed face down in a stepped cavity that prevents damage to the specimen. The sliding cover secures the disc in position.

D248 Disc carrier to take ten (10) 12mm Ø discs

D249 Disc carrier to take eight (8) 15mm Ø discs

Magnetic Pick-up Tool

A convenient magnetic tool for for picking up and manoeuvring discs without damage to the specimen.

T543 Magnetic pick-up tool

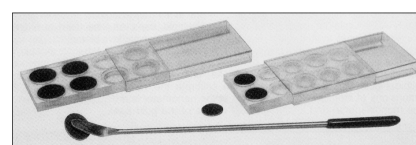

Magnetic Pick-up Tool

M-Bond™ 610 Adhesive



A non-conductive two-component, solvent-thinned, epoxy-phenolic adhesive for high performance applications. Chemically resistant providing a thin layer of glue with good ion milling properties. Has low viscosity with minimum creep, hysteresis and linearity problems. Solids content is 22%. It is an excellent adhesive for mounting samples for TEM dimpling and bonding of samples to TEM grids for imaging or FIB. Operating temperature range short term is

-269° to +370°C; long term, -269° to +260°C.

This may be the widest temperature range general-purpose adhesive that is available.

Kit contains: Resin (4 bottles 14g each) Curing Agent (4 bottles 11g each), 4 brush caps for dispensing mixed adhesives, 4 disposable mixing funnels and instructions.

AXXX

Lacomit Varnish and Remover

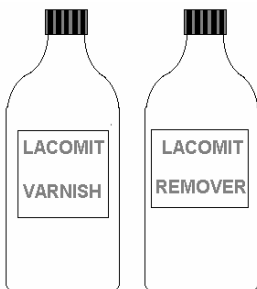

For those who wish to prepare thinned TEM specimens by one of the 'window' techniques, Lacomit is a peelable varnish for blanking off the portions of the specimen that are not to be polished. A solvent remover is also available. Both reagents are flammable and special transportation and limitations apply for shipping overseas.

L063 Lacomit varnish 500ml
L064 Lacomit remover 500ml

SEM Finder Grid

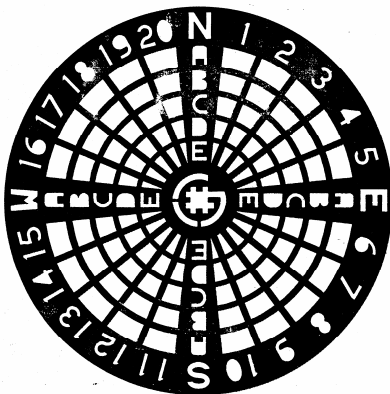

This finder grid incorporates several easy location features for the identification of areas of special interest. Grid available in copper, nickel or gold.

- The annular ring identifies North, East, South and West
- The four quadrant markers are tapered towards the centre
- 100 radial sectors are easily identified by reference to decimal numbers in the annular rim and alphabet letters in the four quadrants
- A matt surface on one side is for correct positioning - matt side up

Overall diameter 10mm
Thickness 50µm

G198/C SEM finder grid *copper* (10)
G198/G SEM finder grid *gold* (5)

G198/N SEM finder grid *nickel* (10)

Phosphor Powder

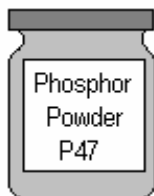

For those wishing to prepare their own scintillator discs, TAAB offers a P47 phosphor powder to a specification recommended for scintillator coating.

P065 Phosphor powder P47 25g

Scintillator Discs

Plano P47 Scintillator Discs

These discs are highly recommended for routine use, being coated with a very uniform layer of carefully selected P47 phosphor. They have a high signal output and a good working life. They should not normally be coated with aluminium unless cathodoluminescence studies are envisaged. An aluminium coating reduces the efficiency by some 20%. Discs are available for all principal types of microscopes. Special sizes are available on request.



YAG Single Crystal Scintillator Discs

Yttrium Aluminium Garnet has a very fast response time of 50-60 ns and unlike plastic or most phosphor scintillators they do not degrade when bombarded by electrons or ions. They are very suitable for high current operations and have a very long lifetime. Light emission peaks about 560nm, response time below 5kV is better with YAG than for P47. The crystal should be coated with 50nm of aluminium before use. If the layer becomes damaged it can be removed with sodium hydroxide without damaging the surface of the crystal. The crystal is mounted with the matt surface in contact with the light pipe as this has been shown to increase efficiency.

The discs are all 1mm thick unless otherwise specified.

YAP Single Crystal Scintillator Discs

Yttrium Aluminium Perovskite crystals are more efficient in light output than YAG (see graph). Also the emission spectrum peaks at about 378nm which corresponds closely to the maximum sensitivity of the S11 photo multiplier that is in general use in most electron microscopes. There is therefore a significant improvement in signal by using the YAP crystal rather than the YAG. The decay time of YAP crystals is 40ns compared with YAG of 80ns, so overall performance of YAP is superior to YAG.

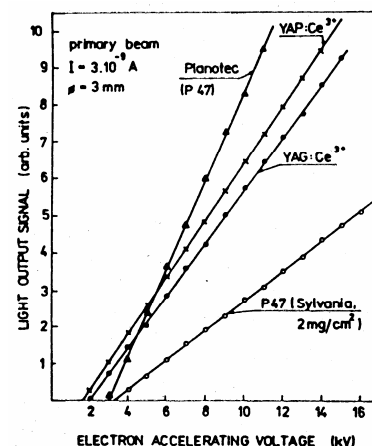

Usage Chart

Diameter	Instrument	P47	YAG	YAP
7.7mm	ISI Mini SEM	S214	S214/G	S214/P
8.8 x 2mm	JEOL, JSM, T20, T200, 840	S215	S215/G	S215/P
9.0 x 3mm	ETEC	S216	S216/G	S216/P
10.0mm	Cambridge/LEO (except S600), AMR1200	S217	S217/G	S217/P
12.0mm	Cambridge S600	S218	S218/G	S218/P
12.0 x 0.17mm	Zeiss SEM	S219	S219/G	S219/p
12.4 x 3.2mm	Cameca	S220	S220/G	S220/P
13.7mm	ISI, JEOL	S221	S221/G	S221/P
16.4 x 0.17mm	Zeiss, Novascan, Semco/Zeiss	S222	S222/G	S222/P
18.0mm	Camscan/Balscan	S223	S223/G	S223/P
19.8mm	Hitachi with metal ring	S224	S224/G	S224/P
20.0mm	JEOL except JSM T20, T200, 840, AMR1000, 1400, 1600, 1700	S225	S225/G	S225/P
20.0 x 2mm	Philips	S226	S226/G	S226/P