

Petri Dish – Polystyrene

Clear plastic disposable dishes, 90mm diameter x 12mm deep. Produced under sterile aseptic condition, comply with BS611 part 2 and can be used in automatic plate pouring machines

Product Circular	Description	Diam. x Depth mm	Quantity
P051	Triple vent	90 x 12	100
P250	2 Compartment, vented	90 x 12	100
P251	3 Compartment, vented	90 x 12	100

Square

P297	No vent	100 x 18	120
P298	Repli-dish with 25 - 18 x 18mm compartments each approx 1ml capacity	100 x 18	120

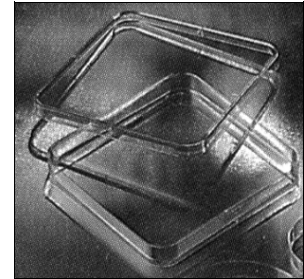
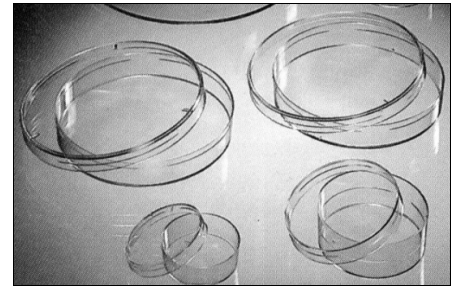

Petri Dish – Pyrex

A range of 20mm deep glass Petri dishes with 15mm deep covers, available singly.

Product Circular	Description	Base Diam. x Depth, mm	Cover Diam. x Depth, mm	Quantity
P224	60 x 20	54.5 x 20	55 x 15	1
P225	80 x 20	74 x 20	75 x 15	1
P226	100 x 20	94 x 20	95 x 15	1

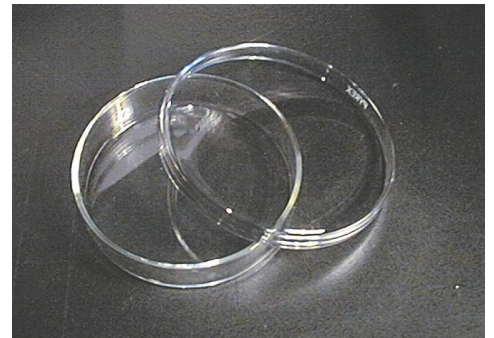

Filter Papers

Qualitative general purpose paper 0.18mm thickness.

P227	Filter paper No1, 90mm diameter	box 100
P228	Filter paper No1, 125mm diameter	box 100
P229	Filter paper No1, 55mm diameter	box 100
P295	Filter paper No1, 70mm diameter	box 100



Forceps - Membrane Filters

Membrane filters should only be handled with suitable forceps in order to avoid contamination, which can result from hand contact. These stainless steel forceps have smooth, flat tips. They are autoclavable and can be flamed.

T169	Forceps, stainless steel, membrane filters	each
------	--	------

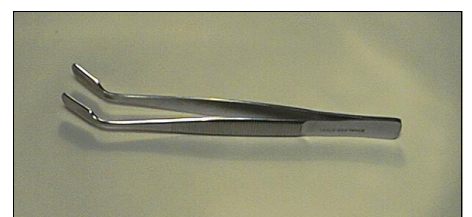

Petri Dish Stand

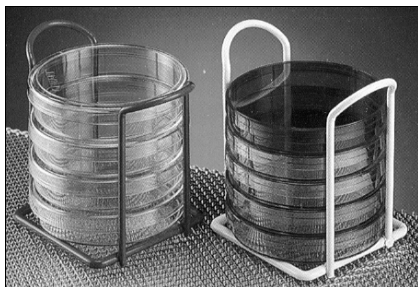

These useful stands will hold up to six 90mm Petri dishes. Manufactured from epoxy coated steel, dispenses 90mm Petri dishes from the base by gravity feed. Fully autoclavable and ideal for small batch incubation. The stands are available in seven different colours for easy batch coding.

P243	Petri dish stand – white	each
P244	Petri dish stand – red	each
P245	Petri dish stand – blue	each
P246	Petri dish stand – black	each
P249	Petri dish stand – grey	each

Plasticine



Soft moulding compound. In packs of 500g.

P234	Plasticine – blue	each
P235	Plasticine – white	each
P236	Plasticine – red	each
P237	Plasticine – grey	each

Melinex Film

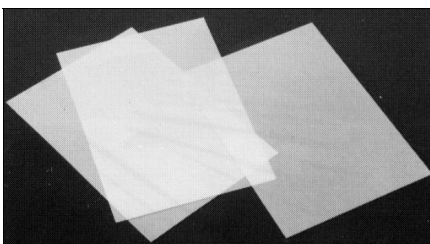

Ideal substrate for growing cell cultures which later can then be incorporated into blocks. Supplied as 10 x A5 sheets of Melinex, thickness 175µm.

M363	Melinex film - A5	pack 10
-------------	-------------------	---------

Weighing Paper

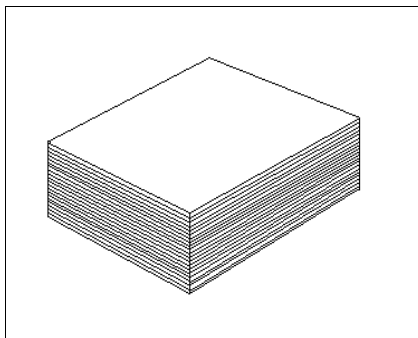

A special paper with a glossy surface which makes it very suitable for weighing powders. Dimensions are 100mm x 100mm

W105	Weighing paper 100mm x 100mm.	pack 1000
-------------	-------------------------------	-----------