

## TAAB Embedding Oven

A chest type oven with an operating temperature range of +40°C to 100°C. The temperature required is easily selected by the control knob on the front panel. Designed to maximise oven chamber space, the oven is capable of taking up to 416 TAAB capsules for polymerisation when mounted in the carrier trays provided. BEEM capsules trays (not provided) can be stacked on the carrier tray, then 5.2mm or 8mm BEEM capsules or a variety of embedding moulds can also be used.

The high precision oven is designed around a high thermal mass cast aluminium chamber which, together with a lid fabricated from aluminium plate, provides a construction with uniform heat distribution from replaceable heating elements embedded in the oven wall. The temperature differential throughout the oven is consequently very small. The construction also allows for rapid re-attainment of air temperature in the oven if the lid is removed. The body of the oven and the lid are efficiently insulated.

A probe buried in the body of the oven senses the temperature. This probe feeds a sophisticated electronic control system that controls the 4 elements in a proportional manner so there is consequently no differential in the heating cycle. The electrical supply to the circuitry is via a stabilised DC power supply that makes the oven insensitive to mains voltage fluctuations. The oven is insensitive to changes in the ambient temperature.

<b>E062</b>	TAAB embedding oven – 240 volt	each
<b>E063</b>	TAAB embedding oven – 110 volt	each
<b>E064</b>	Conversion trays – 8mm to 6mm	set 4

The conversion trays accept only TAAB 6mm capsules.

<b>E062/E</b>	Oven element – 240 volt	each
<b>E063/E</b>	Oven element – 110 volt	each

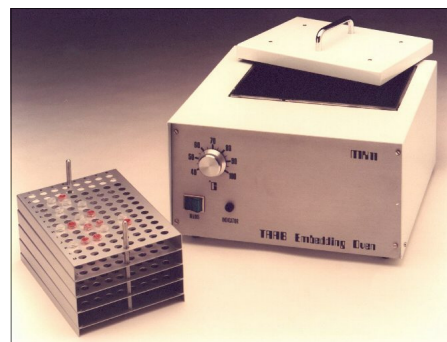

### SPECIFICATION

Internal dimension:	22.5 x 14.5 x 14cm
External dimension:	33.5 x 30.5 x 23cm
Temperature range:	40°C to 100°C
Temperature differential throughout oven:	0.5°C
Temperature differential at set temperature:	0°C
Accuracy:	0.5°C
Repeat accuracy:	0.25°C
Permissible variation in mains voltage:	15%
Rated voltage:	230v 50/60Hz 110v 50/60Hz
Power consumption:	100Va

The oven is built with a secondary safety thermostat which cuts the power supply should temperature exceed 105C.

## TAAB Oven with Temperature Readout

This model has all the features of the standard oven but has in addition visual temperature readout display. A three digit LCD with 15mm high digits is panel mounted to the front of the oven for ease of viewing.

<b>E100</b>	Embedding oven with temp/readout – 240 volt	each
<b>E101</b>	Embedding oven with temp/readout – 110 volt	each

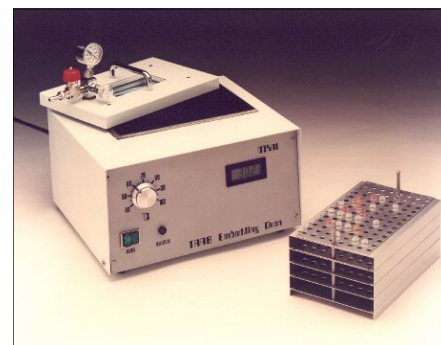

Oven shown with Optional vacuum lid

## Oven Vacuum Lid

The TAAB oven vacuum lid comes as standard with valves, vacuum gauge and a large glass viewing window. For those wishing to reduce costs without affecting the performance of the unit, there is a version without a vacuum gauge. The vacuum lid converts the TAAB Embedding Oven into an environment suitable for polymerising resins in a vacuum or in an inert environment that is particularly suitable for resins, which need to polymerise in an oxygen free gas.

The design of the TAAB oven is such that with a vacuum facility it becomes an ideal vessel for WAX impregnation of specimens, speeding up impregnation with a higher reproducibility of results.

<b>E087</b>	Oven vacuum lid – with gauge	each
<b>E104</b>	Oven vacuum lid – without gauge	each
<b>E087/G</b>	Replacement silicone gasket	each

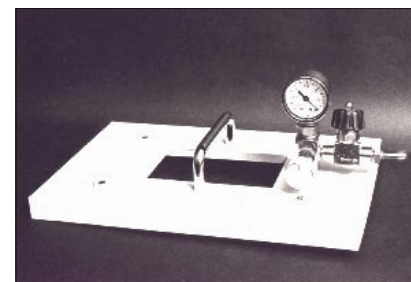

See page No.5.18 for details on the range of Mini-Vacuum pumps. Model **V079/KN** is recommended for use with the TAAB vacuum oven with the **V079/KT** where corrosion resistance is required.

# 5

# Specimen Preparation



## Incubators

Temperature range - Ambient +5°C to 70°C without fan  
Ambient +8°C to 70°C with fan

This general purpose **mini economy range** are highly efficient, reliable and cost effective. **The exterior** is constructed from sheet steel finished in an "easy clean" powder coated paint. **The interior** chamber is made from mild steel coated with aluminium (a stainless steel interior is an option). Fitted with fixed shelf runners and removable chrome plate wire grid shelves. There is a solid steel door as standard (Integral viewing window optional as is a double door, steel outer, glass inner). **Heating** is by Incoloy sheathed elements positioned below the chamber floor (natural convection units) and around the fan on the back wall (mechanical convection units) The simple to use thermostat system. **The control system** comprises a direct reading thermostat and an over-heat thermostat both with calibrated scales tamper-proof locks.. Mains power and over-heat indicators. For fan oven please add /F to catalogue number.

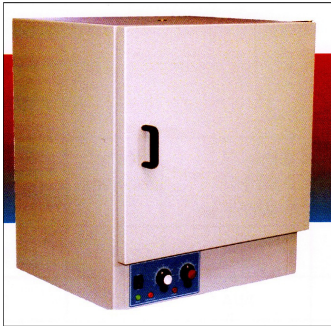

Digital Range also available

Please ask for particulars

## Specifications

Cat. No.	Volume litres	Internal Dims. H x W x D cm	Ext. Dims H x W x D cm		No. of shelves	No. of positions	Weight (Kg)
			No fan	With fan			
IXXX	6	15x23x19	39x32x33	N/A	1	1	7
IXXX	18	26x26x27	52x38x41	N/A	2	2	14
IXXX	30	24x36x35	50x48x49	50x48x62	2	2	20
IXXX	40	32x36x35	58x48x49	58x48x62	2	3	23
IXXX	50	33x49x33	59x61x60	59x61x59	2	3	26

## Ovens +40° to 250°C

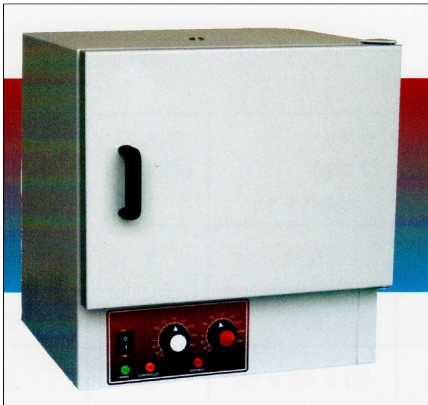

## TAAB Rotators

The **TAAB Rotator** imparts a gentle rotary motion to specimens during processing and is suitable for all fixing, staining, washing, dehydrating and embedding procedures. This speeds up penetration and ensures uniform exposure of the specimen to reagents. The standard head accepts 12 vessels up to 25mm Ø and the speed of rotation can be 2, 4 or 10 rpm. This ensures no frictional damage to the specimen and even viscous embedding media will be kept flowing during specimen impregnation. The small size of the Rotator allows use in refrigerator or incubator as well as on the bench and It will operate in the temperature range 0 to 32°C. The **standard** head can be exchanged at a small cost for other optional heads (see below). It may then necessary to raise the rotator to prevent the larger diameter head or vessels from touching the bench and TAAB offer a stand (**R070**) to raise the rotator 1" to avoid this problem.

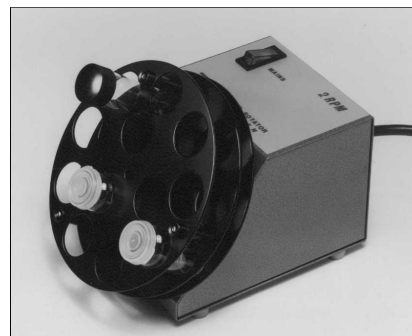

**Overall dimensions:**  
14cm wide x 21cm deep x 13.5cm high  
Weight: 1Kg

Designed to be used with glass vials G060, G061 with clip on closures and G074, G075 and G076 with screw on closures or similar vessels.

**R050** Rotator 2rpm – 240 volt 50Hz  
**R051** Rotator 2rpm – 110 volt 60Hz  
**R051/1** Rotator 2rpm – 110 volt 50H  
**R052** Rotator 4rpm – 240 volt 50Hz  
**R053** Rotator 4rpm – 110 volt 60Hz

**R053/1** Rotator 4rpm – 110 volt 50Hz  
**R054** Rotator 10rpm – 240 volt 50Hz  
**R055** Rotator 10rpm – 110 volt 60Hz  
**R055/1** Rotator 10rpm – 110 volt 50Hz

## TAAB Varispeed Rotator

The **TAAB Varispeed Rotator** offers the technician complete flexibility. It is capable of performing the duties of the original fixed speed range and still much more besides. The range of approximately 1 to 36 revolutions per minute is infinitely variable and the torque is constant throughout the speed range. The angle of tilt of the rotator head assembly is adjustable from a horizontal position through 75° movement, thereby greatly extending the possible use of the rotator. The rotator overall size of 17.5cm x 17cm x 19cm is small enough to permit its use in confined spaces.

The rotator comes complete with the **standard** head. However, for a small additional cost it is possible to order the rotator **exchanging** the standard head with one of the optional heads. ( Picture shows rotator with **R062** Optional head).



**Overall dimensions:**  
17.5cm wide x 17cm deep x 19cm high  
Weight: 2.53Kg

## Rotator Heads – Optional

Optional heads are available to extend the use of the TAAB Rotators. Two types of **inversion** mixing heads are available. One, the **R062** is capable of taking up to 12 plastic coated clips at any one time. This head is supplied with 4 x 1½", 6 x 1" and 12 x ½" clips and selection is made by the operator to meet their needs. The other larger diameter head **R071** comes complete with 18 x ½" diameter clips (requires the use of the **R070** Rotator Stand for the fixed speed rotators.)

Two additional **Rotary** heads are available. The **R072** is similar to the standard head but has a larger disc diameter that requires the use of the Rotator Stand for fixed speed rotators. This head has 12 x 30mm diameter holes to accept larger vessels. The second Rotary Head **R073** is of the standard disc size and has 32 x 13mm diameter holes.

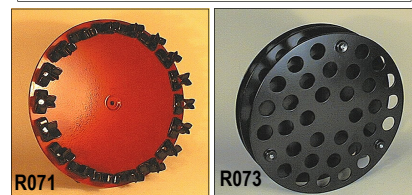

**R062** Optional head – inversion 12 clip type each  
**R071** Optional head – inversion 18 x ½" clip type each  
**R072** Optional head – rotary 30mm diameter type each

**R073** Optional head – rotary 12.5mm diameter type each  
**R070** Rotator stand – for **fixed** speed models each

**EXCHANGE HEAD** - When ordering a new Rotator, to exchange the **standard** head for one of the **optional** heads, order the Optional head with a " /E " suffix (example R072/E) – see price list.



# 5

# Specimen Preparation



SRT6



SRT9

## Tilting Roller/Mixer

Rocking and rolling action for complete mixing with a six roller design (SRT6) with small footprint or nine roller model (SRT9) for high throughput. Both designed for continuous quiet operation in cold rooms down to 4°C or incubators up to 60°C and 80% humidity. **Analogue control** is through a simple on/off switch and the unit will run continuously at the fixed speed of 33rpm. More advanced **digital model** SRT6D & SRT9D with variable speed from 5 to 60rpm and versatile timer which can be set from 1 second to 9 hours.

Both roller mixers are robustly constructed and designed for easy cleaning, having plastic rollers and a drip tray to collect accidental spillages. Most sizes of tubes, Bijoux, Universals and bottles can be accommodated, up to 100mm diameter. An accessory stacking system SRT/STACK is available where bench space is at premium.

Stacking Kit



SRT9D and SRT6 Stacked



Model	SRT6	SRT6D	SRT9	SRT9D
No. of Rollers	6	6	9	9
Speed range rpm	33	5-60	33	5-60
Roller L x D mm	340 x 30	340 x 30	340 x 30	340 x 30
Size W x D x H mm	240 x 565 x 110	240 x 565 x 110	240 x 565 x 110	240 x 565 x 110
Weight Kg	5.1	5.1	6.9	6.9

- R084** Tilting roller/mixer SRT9 - 9 roller **analogue**, fixed speed 230v 50Hz each
- R085** Tilting roller/mixer SRT6 - 6 roller analogue, fixed speed 230v 50Hz each
- R090** Tilting roller/mixer SRT9D - 9 roller **digital**, variable speed 230v 50Hz each
- R091** Tilting roller/mixer SRT6D - 6 roller digital, variable speed 230v 50Hz each
- R092** Stacking accessory kit 4x stacking blocks each



## Vibro-Gene® Mixer Shaker

Silent and vibration free mixer/shaker, mixes in seconds combining the action of a vortex mixer and shaker for mixing samples in 0.5 and 1.5ml conical or other tubes with samples as small as 10µl. Built-in illumination to facilitate viewing of samples. The vibrating bar is made of rubber with V shaped slots cut into it and vibrates at 2500 oscillations per minute. Sample tubes are held with the lower end of the tube located in a slot or against the vibrating bar. An illumination window is located under the vibrating bar so that samples are viewed against a bright background. Illuminated mains on/off switch that also switches on the illumination and a separate switch for the shaking action. Overall dimensions: H13cm x W11cm x D15.5cm. Weight net. 3Kg.

- M170** Vortex mixer shaker – 240 volt each

## Autovortex Mixers

Robust vortex mixer for single hand operation. Starts automatically when the cup is pressed down. Vibration free and quiet. Rubber cup with non slip surround for use with either single tube in the middle of the cup or one or more tubes on the surround. For use with tubes from 0.5ml conical to large tubes and small bottles. Overall dimensions: H 8cm x W 13cm x D 21cm. Weight net 1.5Kg. Model **M171** has a fixed speed of 2500 rpm and **M172** has a variable speed between 250 – 2500 rpm.

- M171** Autovortex – fixed speed – 240 volt each

Variable speed model is similar to M171 fixed speed

- M172** Autovortex – variable speed – 240 volt each





## Critical Point Dryers

### Critical Point Drying

This is the most commonly used method of drying samples prior to examination by SEM. Drying is done in a manner that will minimise damage due to the surface tension effects of drying that would otherwise result in the deformation and collapse of delicate tissue structure.

**The method** is to use the property of a liquid to change to a gaseous phase without a density change. The temperature and pressure at which this occurs is the critical point. Put simply, at the critical point liquid inside the specimen changes to gas in such a way that no stress is caused to the sample.

**The choice of fluids** is very limited and carbon dioxide is universally used today. With CO<sub>2</sub> a critical point of approx. 35°C can be achieved at a pressure of around 1200 psi. Therefore, if the water is replaced with liquid CO<sub>2</sub> and the temperature then raised to above the Critical Temperature the liquid CO<sub>2</sub> changes to vapour without change of density and therefore without surface tension effects which distort morphology and ultrastructure. Since liquid CO<sub>2</sub> is not sufficiently miscible with water it is necessary to use an intermediate fluid which is miscible with both water and CO<sub>2</sub> such as methanol, ethanol, amyl acetate or acetone.

### Model E3100

Simple robust construction, easy to use and service. Features a horizontal sample chamber with large viewing window. Three pressure valves permit easy connection to the liquid CO<sub>2</sub> cylinder, liquid agitation and venting of the chamber. Every CPD is pressure tested to 2000 psi at an independent laboratory and a pressure-bursting disc is fitted to safeguard against misuse. There is a range of specimen holders available to accommodate most types of specimens (including very small), grids and cover slips.

The design of the **E3100** features a horizontal pressure chamber 64mm internal diameter x 100mm in length. Integral water jacket, removable rear door and front 25mm viewing window, temperature and pressure gauges, safety over pressure bursting disc, C133/3 tissue holder with baskets, flexible CO<sub>2</sub> connector and water hose.

**C133/L** Critical point dryer model **E3100** each

#### Accessories for C133/L

<b>C133/01</b>	Specimen holder for 3.05mm Grids	each
<b>C133/08</b>	Replacement safety bursting disc	each
<b>C078/1</b>	Porous specimen pots 12.7mm 15.7mm	pack 10
<b>C080/1</b>	Porous specimen pots 25.4mm x 25.4mm	pack 10



#### Accessories for C133/L

**C133/L07** Specimen holder for tissue (boat)  
**C133/L08** Specimen holder for coverslips

Spares available - please ask

### Model K850

Simple to operate, the **K850** is an alternative model to the CPD7501 when cooling water is **not available** or **desirable**. The **K850** is fitted with Thermoelectric Heating and adiabatic cooling and temperature control of +5°C on cooling, and +35°C on heating. The chamber is vertical with top loading to ensure specimens do not become uncovered during the drying process. There is a side viewing port to locate the meniscus for the correct level when initially filling the chamber. Normal operating temperature 35°C, pressure 1500 psi. The chamber is illuminated and has a side viewing port with protective shield. There is pressure monitoring with a pressure relief valve and rupture disc protection.

**C207** Critical point dryer model **K850** each

#### Accessories

<b>C207/H</b>	Specimen holder	each
<b>C207/C</b>	Porous specimen pots	pack 10

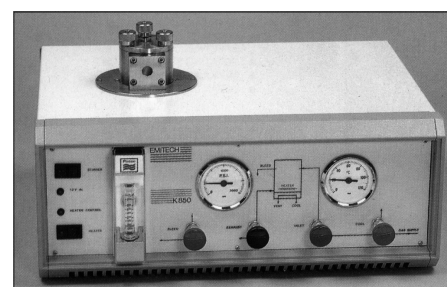

## Critical Point Dryers - continued

### Leica EM CPD300 Automated Critical Point Dryer



The drying of biological specimens such as pollen, tissue, plants, insects, as well as industrial samples, for example MEMS (Micro Electro Mechanical Systems) for SEM analysis can be prepared in the Leica EM CPD300 Critical Point Dryer, fully automatically.

To ensure a low CO<sub>2</sub> consumption and a very short process time a new filler concept was developed. Special attention has been turned to safety by implementing software controlled cut-off functions and integrating a waste separator for safe and easy disposal of exchange fluid thus avoiding direct contact with the user. The drying of biological specimens in the Leica EM CPD300 Critical Point Dryer is fully automatic.

A wide selection of specimen holders is available to suit every sample.

**CXXX** EM CPD300 Critical point dryer

## Hotplates & Magnetic Stirrers

### Hotplate – Ceramic



**US160** Energy efficient, fast response and accurate.

The glass ceramic top gives excellent chemical and temperature resistance, is easy to clean and stays cool at the edges. The cast aluminium body is shaped for stability and also helps deflect spills away from the controls and the user. The instrument is built to a very high standard with fitting for detachable retort stand situated on the back of the instrument.

The "Hot" warning light will flash whenever the plate temperature is above 70°C and will operate even when the hotplate is turned off if the unit is still connected to the mains.

An independent safety circuit protects against overheating and internal electronic components are protected against corrosion.

The models featured have an analogue displayed temperature and speed control.

Maximum temperature 450°C. Heater power 500 watts. Plate area 15 x 15cm.

Overall dimensions – H12.2 x W17.2 x D25.0cm. Weight 2.2Kg.

**H063** US160 Ceramic top hotplate 230v 50/60Hz each

**M131** Retort rod, plated mild steel 600 x 12.0mm dia. each

### Hotplate—Coated Aluminium/Silicon



**UC150** Rugged and reliable hotplate with 15 x 15cm cast aluminium/silicon alloy top which will easily withstand the knocks of everyday use. The cast aluminium body is shaped for stability and also helps deflect spills away from the controls and the user. Fitting for detachable retort stand situated on the back of the instrument.

The "Hot" warning light will flash whenever the plate temperature is above 70°C and will operate even when the hotplate is turned off if the unit is still connected to the mains.

Maximum temperature is 325°C with heater power of 700W.

Overall dimensions – H11.0 x W19.0 x D30.0cm. Weight 3.4Kg

**H059** UC150 Hotplate 230v 50/60Hz each

**M131** Retort rod, plated mild steel 600 x 12.0mm dia. each

## Magnetic Stirrer - Ceramic

**UC151** The general description is the same as for the Ceramic Hotplate. Powerful magnets and motor give stirring speed from 100 to 2000rpm and volumes up to 15 litres (based on 15 litres of water contained in a 20 litre flat bottom boiling flask). Supplied with two 25mm PTFE coated magnetic followers.

Speed range 100 – 2000 rpm.  
Plate dimension - 15 x 15cm.  
Overall dimensions – H10.7 x W17.2 x D24.8cm. Weight 2.0Kg

**M173** UC151 ceramic magnetic stirrer 230v 50/60Hz each  
**M131** Retort rod, plated mild steel 600 x 12.0mm dia. each



## Magnetic Stirrer - Stainless Steel

**US151** A high quality reliable stirrer with powerful drive magnet. Variable speed from 100 – 2000 rpm . The cast aluminium body is shaped for stability and also helps deflect spills away from the controls and the user. The stainless steel top plate is robust and unlike aluminium does not produce eddy currents so ensuring a very powerful coupling and stirring action. With facility for retort rod and supplied with 2 x 25mm PTFE coated stirrer bars. Overall dimensions – H10.70 x W17.2 x D24.8cm. Weight 2.0Kg

**M129** US151 magnetic stirrer with SS Plate 230v 50/60Hz each  
**M131** Retort rod, plated mild steel 600 x 12.0mm dia. each



## Magnetic Stirrer – Battery

**SM27** Battery operated magnetic stirrer, ideal for fieldwork or in incubators etc. where mains power is not available. Tough ABS case with easily accessible battery compartment. Variable speed control up to 1300 rpm. Supplied with four batteries and 1 x 25mm PTFE coated stirrer bar. May also be powered from the mains supply or from a car battery using the accessory adapters, please enquire. Overall dimensions – H7.0 x W15.0 x D16.0cm. Weight 1.3Kg.

**M133** SM27 magnetic stirrer – battery each  
**M133/B** Battery D size - 1.5 volt, pack of 4 each  
Battery life 600 hours continuous use

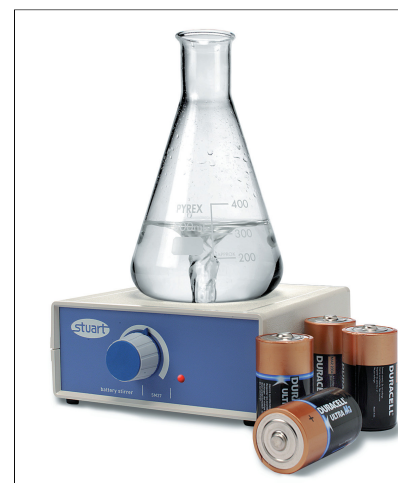

## Magnetic Stirrer/Hotplate – Ceramic

Model **UC152** . This instrument has the specifications of the two individual units **H063** and **M173**. Power consumption 500w

Weight 2.9Kg

**M174** UC152 ceramic stirrer hotplate 230v 50Hz 500w each  
**M131** Retort rod, plated mild steel 600 x 12.5mm dia. each





## Magnetic Stirrer/Hotplate



**SB162** This instrument has the same specifications as the two individual units **H059** and **M129**. Weight 2.9Kg. Power consumption 700w

**M130** SB162 magnetic stirrer/hotplate 230v 50Hz each  
**M131** Retort rod, plated mild steel 600 x 12.5mm dia. each

## Magnetic Followers

A range of PTFE encased magnetic stirrer followers.

**Cylindrical** - Plain or with centre pivot rim used for routine stirring operations, different lengths give different stirring characteristics.

**Crosshead** - Designed for tube-type containers.

**Oval** - designed for stability at high speeds in round bottom flasks or vessels.

**Triangular** - Particularly effective for dissolving solids and mixing sediments.

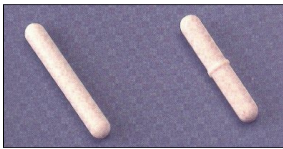

Cylindrical

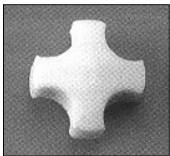

Crosshead

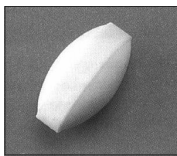

Oval



Triangular

### Cylindrical - Plain & with Rim

Length mm	Plain	Rim	Quantity
12	<b>M132/5</b>	<b>M358/1</b>	3
15	<b>M132/1</b>		3
20	<b>M132/2</b>	<b>M358/2</b>	3
25	<b>M132/3</b>	<b>M358/3</b>	3
40	<b>M132/4</b>	<b>M358/4</b>	3

### Micro Flea with Rim

Length x Diam. mm	Rim	Quantity
7 x 2	<b>M359/1</b>	3
10 x 3	<b>M359/2</b>	3

### Crosshead

Diameter mm	Cat. No	Quantity
10	<b>M360/1</b>	each
14	<b>M360/2</b>	each
17	<b>M360/3</b>	each

### Oval

Length x Diam. mm	Cat. No	Quantity
20 x 10	<b>M361/1</b>	each
25 x 12	<b>M361/2</b>	each
30 x 16	<b>M361/3</b>	each
40 x 20	<b>M361/4</b>	each

### Triangular

Length x Side. mm	Cat. No	Quantity
12 x 6	<b>M362/1</b>	each
25 x 8	<b>M362/2</b>	each
40 x 14	<b>M362/3</b>	each

## Magnetic Retriever

Two types available coated in either polypropylene or PTFE. PTFE is only affected by fluorine containing compounds and molten alkali metals. Maximum working temperature of PTFE as coated on followers and retrievers is 300°C.

Both are 350mm long, the polypropylene coated retriever is 10mm diameter and the PTFE is 8mm diameter.

**M175** Magnetic retriever – polypropylene each  
**M176** Magnetic retriever – PTFE each

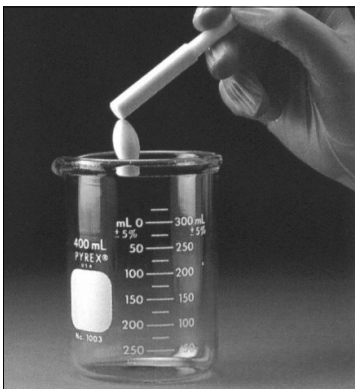

## Halogen Hotplate and Stirrer

Using the rapid heating characteristics of halogen, these latest hotplates and stirrers are **40% faster** and so **use 40% less energy** than conventional ceramic hotplates. Halogen heating is a recent innovation in laboratory hotplate technology resulting in faster and more efficient heating which is highly controllable. Unlike conventional hotplates most of the energy is used to heat the liquid in the container with minimal energy wasted heating intermediate surfaces such as the plate, air gap and vessel. The elegant glass/ceramic top is *attractive* and *practical*. It is easy to clean, chemical and thermal shock resistant and obviously will not rust or corrode. Safety warning lights alert the user to the top surface heating even after the heater is switched off. The efficiency of the Halogen Hotplate and Stirrer ensures that other surface remain cool even during heating.

### Halogen Hotplate and Stirrer

The Halogen Hotplate HT1 has been designed for maximum stability, providing a safe, convenient heating surface for a wide range of containers and liquid volumes. Vessels up to 5 litres can easily and confidently be accommodated. Halogen heating utilises infra-red energy which directly heats the liquid itself and does not rely on conduction.

**Specification:**

Heater type	Twin infra-red halogen lamps	
Heater output	1.2Kw	
Top surface area	840 <sup>2</sup> cm	
Heating area	420 <sup>2</sup> cm	
Dimensions cm	30L x 30W x 10H	
Maximum temp.	450°C	Weight 4.0Kg



**H066** Halogen hotplate 220/240v 50/60Hz

The Halogen Hotplate and Stirrer has the same dimensions and heating specifications as the Halogen Hotplate but with a sophisticated stirring programme. Stirring speeds are adjustable between 100 and 1000rpm and in addition to automatic gradual acceleration of the bar (which reduces the possibility of decoupling and ensures smooth, continuous stirring on every start), the linear response speed scale makes stirring highly controllable over a wide range of speeds.

**H067** Halogen Hotplate/Stirrer 220v 50/60Hz *Weight 5.2Kg*

**Accessories**

**H068** Retort rod, clamp, boss-head and fixing brackets to suit all models

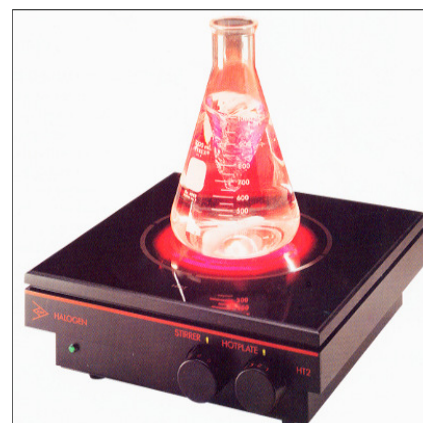

## Overhead Stirrers

An advanced range of overhead stirrers with the following features:

**Overload Protection**

Protects the stirrer from mechanical overloading and overheating. A microprocessor reduces the power to the motor under strain conditions and will stop the motor if overload becomes critical.

**Sophisticated Speed Control**

Advanced circuitry gives outstanding speed control and maintains the set speed even if the load conditions change. A soft start facility prevents splashing on start-up.

**Powerful Motor**

DC permanent magnet motor gives powerful stirring and reliable performance even when in continuous use.

**Keyless Chuck**

Chuck is very easy to use as the mechanism is operated by hand without the need for a chuck key or any other tool.

**Robust and Stable Stand**

Robust stainless steel support rod and accessory retort stand with H-pattern base for stability.

**Enclosed Power Lead**

Safety feature designed to keep lead away from moving parts and liquid splashes

**Good Choice of Stirrer Paddles** (see next page)



# 5

# Specimen Preparation



## SS10 General Purpose Overhead Stirrer

Easy to use and quiet running. Ideal for day to day laboratory use with aqueous and low viscosity liquids such as light oils up to 15 litres. Good speed control and overload protection, features usually found in more advanced models. Excellent value for money.

**S388** SS10 General purpose stirrer 230v 50/60Hz

## SS20 High Performance Overhead Stirrer

A powerful stirrer designed for demanding applications. Suitable for stirring liquids up to medium viscosity such as oils and media up to 25 litres. The SS20 features a hollow shaft arrangement for simple adjustment of the paddle height without moving the motor.

**S389** SS20 High performance stirrer 230v 50/60Hz

## SS30 Dual Torque Overhead Stirrer

A versatile heavy duty stirrer with the ability to mix high viscosity liquids including heavy oils, up to 40 litres. There are two modes of operation that can be easily alternated: **Mode 1** gives high torque at lower speeds and is ideal for stirring very viscous liquids. **Mode 2** has lower torque at higher speeds and provides brisk mixing of medium viscosity liquids. Also has hollow shaft for easy height adjustment without moving the motor.

**S390** SS30 Dual torque mixer 230v 50/60Hz

To assemble a system select:

- 1) The type of stirrer (e.g. SS20)
- 2) The length of stirring rod(s)
- 3) The type of stirring paddle(s)

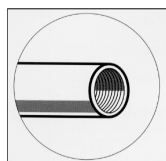

## Stirring Rods

There are two lengths of stainless steel paddle rod and five different paddle heads. The heads screw on so they can be mixed and matched according to stirring requirements.

**R089/350** Paddle rod 8mm Ø x 350mm

**R089/530** Paddle rod 8mm Ø x 530mm

## Stirring Paddles

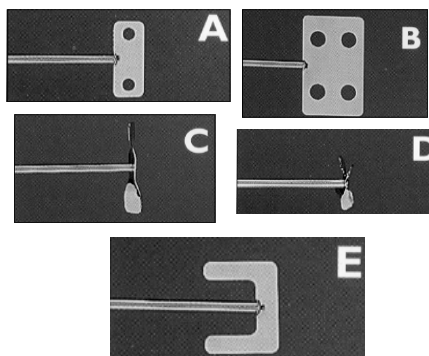

**P499/A** Small Paddle Head **A** (total width 60mm) Provides gentle mixing of liquids with good tangential flow. For use at low to medium speeds.

**P499/B** Large Paddle Head **B** (total width 94mm). As P499/A but greater size to accommodate larger volumes.

**P499/C** Large Propeller Head **C** (total width 80mm). Two blade propeller giving vigorous mixing action pulling material from the bottom upwards.

**P499/D** Small Propeller Head **D** (total width 50mm). As P499/C but with smaller four blade propeller ideal for mixing very viscous liquids.

**P499/E** Anchor Paddle **E** (total width 60mm). Ideal for slow speed agitation.

Note: These overhead stirrers can also use Quickfit® glass and PTFE paddles.

## Technical Specifications

	SS10	SS20	SS30
Max. stirring capacity (litres)	15	25	40
Max. viscosity range	10,000mPas	20,000mPas	80,000mPas
Max. torque at chuck	15Ncm	27Ncm	90/27Ncm
Speed range	100-2000rpm	100-2000rpm	50-500/100-2000rpm
Chuck range	1.5-13mm	1.5-13mm	1.5-13mm
Dimensions of stirrer W x D x H	85 x 175 x 230mm	85 x 195 x 230mm	85 x 195 x 230mm
Support bar Ø x H	12.7 x 240mm	12.7 x 240mm	12.7 x 240mm
Stirrer stand W x D x H. rod Ø x L	350 x 330 x30/16 x 700mm	350 x 330 x30/16 x 700mm	350 x 330 x30/16 x 700mm



## Dilvac Flasks – Borosilicate glass inner

### Dewar Flask – Universal Style

#### *A Dewar flask with handle and lid*

Fitted in highest quality stainless steel containers, therefore rust-free, anti-corrosive, hygienic and strong. This range of Dewars has an all stainless steel lid with self-contained insulation. Toggle clamps secure the lid to the body for safe and watertight transportation.

Product No	Description	Capacity	Container		Flask	
			Diameter	Height	Diameter	Depth
D096	Dewar Stainless Steel	1 Litre	116	228	85	185
D096/F	Refill	1 Litre	—	—	85	185
D097	Dewar Stainless Steel	2 Litre	142	268	106	205
D097/F	Refill	2 Litre	—	—	106	205



### Dewar Flask – Shallow Form with Wide Mouth

#### *Without handle or lid*

Wide mouth shallow Dewars, dish shaped, fitted in stainless steel containers. Can be used with magnetic stirrer, designed to accept standard boiling flask up to 2 litres in capacity, for freezing applications etc. The shallow form configuration allows for minimum of amount of coolant to be used.

Product No	Description	Capacity	Container		Flask	
			Diameter	Height	Diameter	Depth
D131	Dewar Stainless Steel	1 Litre	130	90	100	65
D131/F	Refill	1 Litre	—	—	100	65
D132	Dewar Stainless Steel	2 Litre	150	95	115	70
D132/F	Refill	2 Litre	—	—	115	70



### Dewar Flask – Low Cost, Wide Mouth

#### *With handle and lid*

A range of low cost utility Dewar flasks specially designed for laboratory, hospital and industrial use. Safe for use with all liquid gases and ideal for cold traps. High quality inner flasks, ultra low evacuated, fitted in attractive blue stove enamelled tough mild steel outer container. Steel lid with self contained insulation.

Product No	Description	Capacity	Container		Flask	
			Diameter	Height	Diameter	Depth
D098	Dewar Mild Steel	1 Litre	116	228	85	185
D098/F	Refill	1 Litre	—	—	85	185
D099	Dewar Mild Steel	2 Litre	142	268	106	205
D099/F	Refill	2 Litre	—	—	106	205



## *Dilvac Flasks – Borosilicate glass inner, continued*

### Dewar Flask – Low Cost, Narrow Mouth

Without handle and lid



Product No	Description	Capacity	Container		Flask	
			Diameter	Height	Diameter	Depth
D100	Dewar Mild Steel	0.7 Litre	81	350	54	315
D100/F	Refill	0.7 Litre	—	—	54	315
D101	Dewar Mild Steel	1.1 Litre	106	275	75	235
D101/F	Refill	1.1 Litre	—	—	75	235
D102	Dewar Mild Steel	1.5 Litre	126	290	90	240
D102/F	Refill	1.5 Litre	—	—	90	240

### Dewar Flask – Plastic – Wide Mouth

Represents the **complete** answer in low cost, high efficiency Dewar flasks.

Utilising the proven borosilicate glass inner vessel the dewar features a tough, blue plastic, shock resistant container with many safety features. The unit is easily dismantled to facilitate refill changes and all models include a coated handle and push fit insulated lid which is vented for safe handling of all liquid gases.

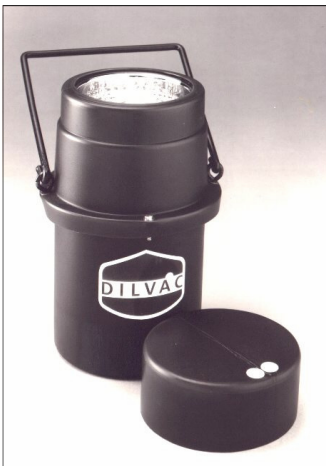

Product No	Description	Capacity	Container		Flask	
			Diameter	Height	Diameter	Depth
D103	Dewar Plastic	1 Litre	145	220	85	185
D103/F	Refill	1 Litre	—	—	85	185

## *Dilvac Flasks – All Stainless Steel*

### Dewar

These vacuum-insulated Dewar flasks made **entirely** of stainless steel can be used for **ultra-low** or **high temperatures** from  $-196^{\circ}\text{C}$  to  $+850^{\circ}\text{C}$ . Impervious to vibration, impact or breakage ideally suited for the storage and transportation of liquid oxygen and liquid nitrogen. With steel detachable swivel handle but **without** lid.



Product No	Capacity	Inside	Outside	Inside	Outside	Nett Wtg. Empty(kg)
		Diameter	Diameter	Depth	Height	
D174	0.5 Litre	65	87	180	204	0.46
D173	1 Litre	85	107	206	232	0.85
D183	1 Litre	100	122	157	177	0.63
D184	2Litre	100	122	285	313	1.23

## Liquid Nitrogen Trolley

Highest quality rigid box section trolley designed for 25 litre Dewars. For smooth effortless motion the trolley has four large rubber covered, castor type wheels, the front two of which are lockable to stabilise the trolley whilst pouring. The trolley is designed for the Statebourne LA25, BOC 25, UC25 (all with trunnions), and used with the cradle adapter, for the UC25 Dewar without trunnions. There is an optional towing handle available suitable for all trolleys.

<b>L053</b>	Trolley/Stand, BOC25 & UC25 <i>with</i> trunnions	each
<b>L053/S</b>	Trolley/Stand, Statebourne LA25 <i>with</i> trunnions	each
<b>L054</b>	Towing handle	each
<b>L055</b>	Adapter for UC25 dewar <i>without</i> trunnions	each

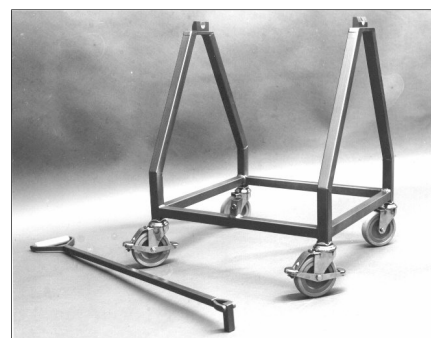

## Statebourne Dewar – 25 Ltr

Top quality 25 litre capacity liquid **nitrogen** Dewar *with* trunnions. Reinforced neck and fitted with efficient sealing plug/cap to minimise nitrogen evaporation.

<b>L057</b>	Statebourne 25 ltr liquid nitrogen dewar	each
-------------	--	------

Dewar shown mounted in L053 Trolley



## Laboratory Lifts

Robust universal elevating platforms, indispensable accessory for all laboratories. They are rigid, sturdy, can be operated very easily and are ideal for holding or supporting flasks, glassware, heating plates, magnetic stirrers etc. The two larger models have a tapped hole with locking nut in the top plate that accepts an M10 threaded retort rod.

Product No	Plate Dimension mm	Max. Height mm	Max. Weight kg	Retort Rod Facility
<b>L066</b>	100 x 100	140	10	No
<b>L067</b>	150 x 150	290	30	Yes
<b>L059</b>	200 x 200	290	40	Yes
<b>L060</b>	Retort Rod - stainless steel, 760mm long x 12.5mm diam.			

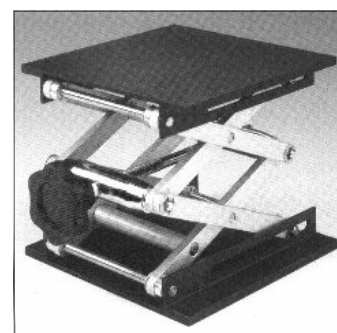

## Vacuum Desiccator – Plastic

A proven design, that provides maximum interior clearances while utilising the same bench space area of other plastic desiccators. Tough transparent polycarbonate top with O-ring seal, polypropylene base and perforated polypropylene plate. With stopcock that accepts 6mm bore flexible vacuum tubing. Do not use with methacrylate embedding media or plastic solvent.

**Desiccant** – Colour change silica gel beads in a cartridge designed to fit the plastic desiccators but can also be used in other desiccators of suitable diameter. The silica gel can be regenerated repeatedly without degradation at 150°C.

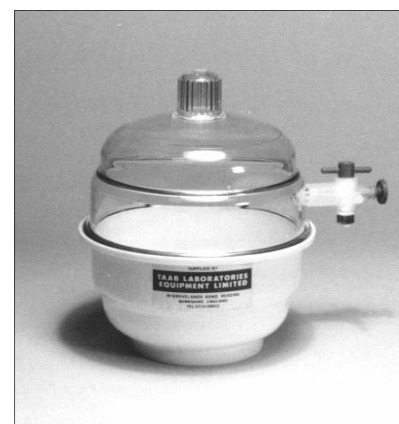

Product No	Flange O.Diam mm	Inside Dia mm	Plate size mm	Overall height mm	Clearance above plate - mm
<b>D105</b>	171	149	140	206	121
<b>D106</b>	230	197	190	260	157
<b>D177</b>	273	240	230	311	197

Desiccant	
<b>D164</b>	114mm diameter
<b>D165</b>	197mm diameter



## Desiccator - Pyrex Glass



Two types available - **Knob Cover** model and **Vacuum** model both with a ground flange these desiccators are supplied without a perforated metal plate that can be ordered separately if required.

The vacuum desiccator is supplied *without* stopcock that can be ordered separately.

Pyrex Glass - Knob cover		Pyrex Glass - vacuum	
Product No	Top internal diam. - mm	Product No	Top internal diam. - mm
D162	150	D178	171
D163	200	D179	230
		D180	Rotaflo stopcock assembly for above

## Small Desiccator Cabinets

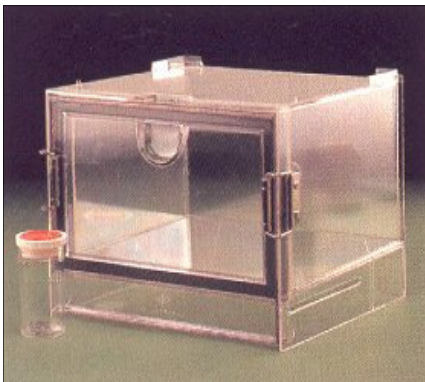

These small injection moulded high impact polystyrene cabinets are strong, rigid and airtight when closed. They are completely transparent for full visibility. The door disappears in a compartment underneath when opened. Up to 5 cabinets may be safely stacked. Supplied with a silica gel bottle. Dimensions: inside 8.25" (21cm) wide x 7" (18cm) deep x 5" (13cm) high.

Door opening 18.8cm x 11cm.

This unit is also available with gas inlet tap for filling cabinet with inert gas such as nitrogen or for drawing a partial vacuum.

D104	Small desiccator cabinet	each
D104/X	Small desiccator cabinet with tap	each

## Gilder Embedding Mould System

# NEW

The EM5 is a newly designed polypropylene 8mm Ø capsule system with a 5 block base each tapering to a 2mm cylindrical cone cap and numbered 1-5. Separate base and body tube sections (1 & 2 shown left) when clipped together form the familiar capsule shape. Resin is easily removed from the system by separating the parts by hand and pushing the cured block out. Blocks up to 20mm in length can be produced but shorter blocks allow easier removal whilst the separate cone base permits easy access for manipulation of specimens.

Each mould strip can be clipped to other moulds to form arrays of a desired size. For volatile resins a cap strip can be inverted onto the top of the mould to form an air-tight seal. Each cavity is numbered 1-5 whilst the end supports have designated areas for writing indexing numbers or comments. Under some applications the units can be re-used if properly cleaned.

**C317** 5 block cylindrical cone cap **2 part** with intermediate piece and cone cap each

**C317/E** 5 block cylinder cone base only each

**C317/INT** 5 block intermediate body piece each

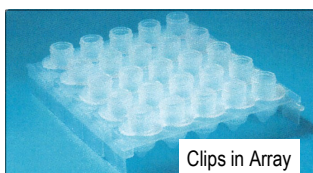
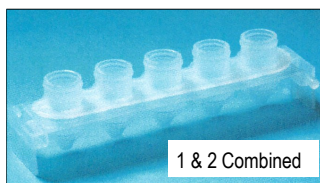
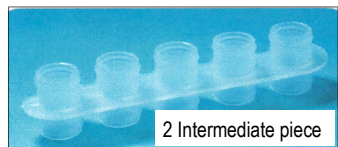
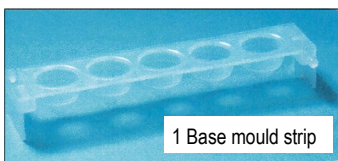

## Heat Pen

A controlled, safe and efficient way of reducing compression in plastic sections. Eliminates the disadvantages of vapour methods which subject the operator to a health hazard. provides an easily controllable amount of heat just above the floating sections. potentiometer control for adjustment of output voltage and LED auto zero current meter.

### Specification

220/240v 50Hz or 120v 60Hz

Dimensions: 65 x 130 x 114mm Power cable 1.8m Penholder cable 1.5m

**P184** Heat pen - deluxe 240v each

**P184/1** Heat pen - deluxe 110v each

**P184F** Replacement filament each



## UV Handlamp

This twin tube UV lamp is manufactured in steel, is compact and easy to use, it is fully filtered to avoid damage to eyes. Ideal for use inside a refrigerator, this lamp has two 6 watt tubes producing **360nm long wavelength UV**. It is suitable for the polymerisation of Lowicryl resins etc.

**L133** UV Lamp - 220v 1

**L134** UV Lamp - 110v 1

**L052/B** Replacement tube 6 watt each



## Vacuum Hand Pump

A reasonably priced all purpose vacuum pump for use in laboratory filtration etc., constructed from high impact plastic the pump is self lubricating and non-corrosive. It will provide a vacuum of 130 Torr (~170mbar) and it has a pumping rate of 15cc/stroke.

**V061** Vacuum hand pump each

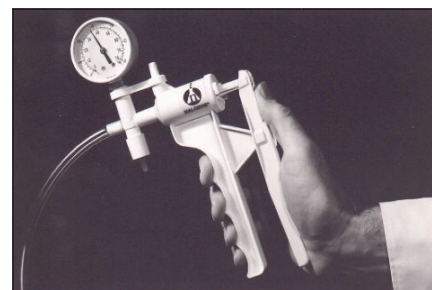



## Checker1 pH Tester

### The Modern Replacement for Litmus Paper

A unique pocket pH meter with a replaceable pH electrode and 0.01 pH resolution the Checker1 offers portable low cost pH measurement. Calibration is simple and can be carried out at 1 or 2 points using a choice of 3 buffers (4.01, 7.01 and 10.01). The meter includes the electrode and a replacement/spare electrode can be ordered separately when required, using the order code P258.

### Technical Specification;

Range, pH	0.0 to 14.0
Resolution, pH	0.01
Accuracy, pH	± 0.2
Batteries/life	2 x 1.4v./3000 hours approx.
Dimensions (w x d x h), mm	66 x 50 x 25 –meter body 76 x 8mm – electrode.

Weight of meter complete with electrode 63 grams.

<b>P257</b>	Hanna Checker1 pH tester	each
<b>P258</b>	Spare electrode Checker1	each
<b>B362</b>	Spare pack of 6 x 1.4v batteries	each

## Piccolo pH Testers



The Piccolo is a revolutionary pH meter with a 4 in 1 “Electrode & Amplifier” design. Conventional pH meters are susceptible to the weak high impedance signal, which makes the electrode, connector, cable and meter delicate and vulnerable, to noise, humidity and dirty environments. Calibration is simple and can be carried out at 2 points using a choice of 3 buffers (4.01, 7.01 and 10.01). Readings are automatically compensated for temperature from 0 to 70°C.

The Piccolo has overcome these problems with a pre-amplified electrode, which delivers a strong signal to the meter. The 4 in 1 interchangeable electrode is inexpensive and rugged and houses the pH sensor, reference system, temperature sensor and the amplifier module.

The Piccolo measures pH wherever necessary. Just switch it on, immerse in the solution and read. Dual point calibration is performed easily through trimmers on the meter's casing.

There are three different piccolo meters in the range:-

<b>Piccolo</b>	has a replaceable electrode of length 90mm
<b>Piccolo2</b>	has a replaceable electrode of length 160mm
<b>Piccolo+</b>	also displays temperature as well as pH readings and has a replaceable electrode of length 160mm

### Technical Specification;

Range, pH	0.0 to 13.0
Resolution, pH/°C	0.01 (piccolo+; temperature resolution 0.1)
Accuracy, pH/°C	± 0.01 (piccolo+; temperature accuracy ± 1)
Compensation	Automatic from 0 to 70°C
Batteries/life	3 x 1.4v./100 hours approx.
Body Dimensions (w x d x h), mm	194 x 29 x 15

<b>P252</b>	Hanna Piccolo pH tester	each
<b>P254</b>	Spare electrode Piccolo (90mm)	each
<b>P253</b>	Hanna Piccolo2 pH tester	each
<b>P255</b>	Spare electrode Piccolo2 (160mm)	each
<b>P493</b>	Hanna Piccolo+ pH tester	each
<b>P494</b>	Spare electrode Piccolo+ (160mm)	each
<b>B362</b>	Spare pack of 6 x 1.4v batteries	each

### TIPS

Do not be alarmed if white crystals have formed around the electrode. This is quite normal and the crystals are simply removed by rinsing with water or when conditioning the electrode.

When the electrode is not in use it is **vital** to keep it moist. Store in **S046** storage solution with sufficient solution to cover the junction. If this is not available Buffer pH4.01 is a good alternative.

**NEVER** store the electrode in Distilled Water



## Hanna pHep pH Testers

**Use for on-the spot pH readings with an accuracy of  $\pm 0.1$  pH.**

A series of fully immersible (waterproof to IP67) pocket pH testers called pHep meters (pronounced FEP)

**pHep 1** pocket pH tester with the benefits of a large LCD display which can be read from any angle, and rugged fully immersible waterproof, ergonomic casing which fits comfortably in the hand. Calibration is two point ( 2 buffer values 4.01 & 7.01 or 7.01 & 10.01)with metal trimmers easily accessible for quick calibration. Batteries are accessible via a slide off cover, the batteries have an approx. 350 hours life.

**pHep 2** has automatic temperature compensation and manual calibration at 2 buffer values.

**pHep 3** has features you would normally expect to see on a bench pH meter. Microprocessor control gives automatic temperature compensation, automatic calibration with 3 buffer values recognised and a pH stability indicator to ensure accurate readings.

### Technical Specification;

Range, pH	0.0 to 14.0
Resolution, pH	0.1
Accuracy, pH	$\pm 0.1$
Temperature Compensation	pHep 2 and 3 only: auto from 0 to 50°C
Batteries/life	4 x 1.4v/300/350 hours approx.
Dimensions (w x d x h), mm	150 x 30x 24, weight: 85grams.

<b>P256</b> Hanna <b>pHep1</b> pH tester	each
<b>P256/2</b> Hanna <b>pHep 2</b> pH tester	each
<b>P256/3</b> Hanna <b>pHep 3</b> pH tester	each
<b>B362</b> Spare pack of 6 x 1.4v batteries	each



## Bench pH Meters

Two bench meters with automatic recognition of 3 buffer solutions and microprocessor controlled calibration for the same price as a portable instrument. Understandably they are two very popular bench pH meters used in a wide range of applications.

Temperature effects are automatically compensated (or manual if preferred) and LCD error codes prompt the user to check the electrode, replace exhausted buffer solutions and so on. Three memorised pH buffer values make calibration quick and easy, (pH 4.01, 7.01 & 10.01) and automatic buffer recognition avoids errors during calibration.

Use P263 for pH, temperature and mV for ISE for Redox work or P263/1 if you only wish to read pH and temperature. Meters are supplied complete with a temperature sensor, a plastic bodied, refillable, double junction pH electrode and 12vDC adapter.

### Technical Specification;

Range, pH/°C/mV	0.0 to 13.0/ 0 to 100°C / & for P263 only $\pm 399.9$ mV(ISE) $\pm 1999$ mV(ORP)
Resolution, pH/°C/mV	0.01/0.1°C/ & for P263 only 0.1mV(ISE) 1mV(ORP)
Accuracy, pH/°C/mV	$\pm 0.01$ / $\pm 0.4$ °C / & for P263 only $\pm 0.2$ mV(ISE) $\pm 1$ mV(ORP)
Compensation	Automatic from 0 to 100°C
Power supply;	240v mains adapter supplied to give meter requirement of 12v DC.
Body Dimensions (w x d x h), mm	230 x 170 x 70 weight: 1.4Kg

<b>P263</b> Bench pH/mV/°C meter	each
<b>P263/1</b> Bench pH/°C meter	each
<b>P264</b> Spare electrode	each
<b>P265</b> Spare temp. probe with 1m cable	each
<b>P492</b> Cantilever electrode holder	each



## Bench Dual-Reading pH/Temp Meter



The 2 LCD display allows the bench meter to show pH (or mV) alongside the temperature reading to allow continuous monitoring of both parameters. Temperature compensation is selectable, either manual or automatic and calibration is simple with the meter automatically recognising 5 pH buffer values 4.01, 6.86, 7.01, 9.18 and 10.1. A mV output is standard to allow connection to a plotter or chart recorder if required. To help the user, the LCD will display error codes should an incorrect buffer be used or electrode need replacing. Supplied complete with temperature sensor, glass bodied refillable pH electrode and 12vDC adapter.

### Technical Specification;

Range, pH/°C/mV 0.0 to 14.0/ -10 to 125°C / & ±399.9mV(ISE) ±1999mV(ORP)  
 Resolution, pH/°C/mV 0.01/0.1°C/ & 0.1mV(ISE) 1mV(ORP)  
 Accuracy, pH/°C/mV ± 0.01/± 0.5°C / & ± 0.2mV(ISE) ± 1mV(ORP)  
 Compensation Automatic from -10 to 125°C or manual from 0 to 100°C  
 Power supply; 240v mains adapter supplied to give meter requirement of 12v DC.  
 Body Dimensions (w x d x h), mm 230 x 170 x 70 weight: 1.5Kg

<b>P350</b>	Bench dual-reading pH/Temp meter	each
<b>P351</b>	Spare electrode	each
<b>P265</b>	Spare temp. probe with 1m cable	each
<b>P362</b>	Cantilever electrode holder	each

## Calibration, Storage & Cleaning Chemicals - pH Electrodes

### Buffers Solutions

NIST traceable buffer solutions

<b>B400</b>	Buffer soln. pH 4.01	460ml
<b>B400/L</b>	Buffer soln. pH 4.01	1ltr
<b>B400/G</b>	Buffer soln. pH 4.01	1gallon
<b>B400/S</b>	Buffer soln. pH 4.01 sachets	25 x 20ml
<b>B401</b>	Buffer soln. pH 6.86	460ml
<b>B402</b>	Buffer soln. pH 7.01	460ml
<b>B402/L</b>	Buffer soln. pH 7.01	1ltr
<b>B402/G</b>	Buffer soln. pH 7.01	1gallon
<b>B402/S</b>	Buffer soln. pH 7.01 sachets	25 x 20ml
<b>B403</b>	Buffer soln. pH 9.18	460ml
<b>B404</b>	Buffer soln. pH 10.01	460ml
<b>B404</b>	Buffer soln. pH 10.01	1ltr
<b>B404/G</b>	Buffer soln. pH 10.01	1gallon
<b>B404/S</b>	Buffer soln. pH 10.01 sachets	25 x 20ml



### Storage Solutions

<b>S046</b>	Storage soln. for pH electrodes	230ml
<b>S047</b>	Storage soln. for pH electrodes	460ml

### Electrolyte Solutions

<b>E045</b>	Electrolyte soln. 3.5M KCl/AgCl	4 x 30ml
<b>E046</b>	Electrolyte soln. 3.5M KCl	4 x 30ml

### Cleaning Solutions

<b>C038</b>	General cleaning	230ml
<b>C038/1</b>	General cleaning	460ml
<b>C039</b>	Protein contaminant cleaner	230ml
<b>C039/1</b>	Protein contaminant cleaner	460ml
<b>C040</b>	Inorganic cleaner	230ml
<b>C040/1</b>	Inorganic cleaner	460ml
<b>C041</b>	Oil/Grease cleaner	230ml
<b>C041/1</b>	Oil/Grease cleaner	460ml

## Checktemp Thermometers

Two models are available the Checktemp 2 and 3 meters which are pocket thermometers with the unique built-in calibration check device and a folding 110mm long probe – designed to fold at different angles for measurement in difficult places.

The calibration check is achieved by simply clicking a switch, which is housed within the battery compartment – if the unit is in calibration the LCD will display 0.0°C.

Highly accurate, these meters display temperature in °C from -20.0 to +120.0°C with an accuracy of 0.3°C (-20 to 90°C).

**Checktemp 2** has a Teflon coated, round tip probe suitable for use in stronger acids and alkalis where stainless steel probes could be damaged. **Checktemp 3** has a stainless steel pointed tip probe and is ideal for temperature checking of semi-solid materials.

### Technical Specification;

Range °C	-20.0 to 120.0
Resolution °C	0.1
Accuracy °C	± 0.3 (-20 to 90), ± 0.5 outside these temperatures
Batteries/life	1 x 1.4v./3000 hours approx.
Probe	folding 110mm x 3mm diameter
Body Dimensions (w x d x h), mm	150 x 30 x 20
	weight; 60gm

**T371** Checktemp 2 thermometer each

**T369** Checktemp 3 thermometer each

**B362** Spare pack of 6 x 1.4v batteries each



## Hand Held Thermometer

A robust thermistor thermometer with strong On/Off switch and supplied with a professional stainless steel general purpose probe (alternative probes for measurements in liquids and air are also available as accessories – supplied with 1m of cable). In the laboratory the requirement for an accurate digital thermometer at a value for money price has meant that this instrument is exceedingly popular, probes can be interchanged without recalibration, a large LCD provides clear, easy-to-read digits that can be read from any angle.

### Technical Specification;

Range °C	-40.0 to 150.0
Resolution °C	0.1
Accuracy °C	± 0.5 full range
Batteries/life	1 x 9v./300 hours approx.
Body Dimensions (w x d x h), mm	180 x 83 x 40
	weight; 240gm

**T372** Hand held thermometer, complete each

**T373** Air/Gas probe type HI 765A each

**T374** Air wire probe type HI 765W each

**T200/B** Battery PP9 – 9 volt, pack of 5 each



## Mini Vacuum Pumps/Compressors

Portable bench-top diaphragm models for a multitude of laboratory uses.

These **low cost, high performance** mini pumps provide a clean evacuation and transfer of air and gases giving a long working life through stress optimised KNF structured diaphragms.

### Technical Features

100% oil-free transfer  
 Pure transfer, evacuation and compression  
 Version for slightly aggressive or corrosive gases  
 Maintenance free  
 Environmentally friendly

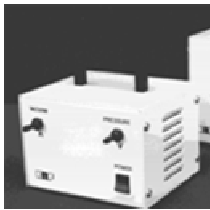

VP1



N86KN



N816KN



N838KN

Number	Model	Material	litres/min	mbar/abs	bar	kgs	mm
V076/KN	VP1	Nitrile	5	100	1.50	1.75	185 x 175 x 145
V078/KN	N86KN	Nitrile	6	100	2.40	1.9Kg	164 x 141 x 90
VXXX/KT	N86/KT	Nitrile	5.5	160	2.50	1.9Kg	164 x 141 x 90
V080/KN	N816KN	Nitrile	30	100	0.50	3.95Kg	361 x 141 x 102
VXXX/KT	N816KT	Nitrile	30	160	0.50	3.95Kg	361 x 141 x 102
V081/KN	N838KN	Nitrile	37	100	0.50	6.8Kg	404 x 210 x 110
VXXX/KT	N838KT	Nitrile	37	150	0.50	6.8Kg	404 x 210 x 110

## Starter Kits for Technovit Plastic LM Embedding

The Histotechnic cold curing plastic embedding systems developed by Kulzer in collaboration with well-known scientists are available to beginners as starter kits. The 7100 kit was specially developed for routine procedures in Life sciences and 8100 for immunocytochemical studies. The kits offer low toxicity and outstanding results even for the beginner.



### 7100 Kit

500ml Technovit 7100	1 piece Histoknife holder	100 pieces Histobloc
5 x 1g hardener I	100 pieces Histoknife H	1 piece Histoform S or Q
40ml hardener II	100g Technovit 3040	80ml Technovit 3040

T221 Histotechnic set 7100 in presentation case

### 8100 Kit

500ml Technovit 8100	1 piece Histoknife holder	1 piece Histoform S or Q
5 x 0.6g hardener I	100 pieces Histoknife H	80ml Technovit 3040
30ml hardener II	100g Technovit 3040	closing devices
500 cover foils	100 pieces Histobloc	



## TAAB Embedding Capsules

TAAB manufactures an extensive range of high quality, low cost embedding capsules with airtight snap-on integral caps. These capsules are available in 8mm and 6mm diameter, **polyethylene** (soft) for low temperature curing up to 75°C, or **polypropylene** (hard) for high temperature curing up to 100°C, which can also be autoclaved. Three tip designs to choose from to produce 8mm diameter blocks with **truncated cone** that ends in a 1.4mm diameter flat, a **truncated pyramid** having a 1mm square end and a **full flat ended** block and 6mm diameter blocks with truncated **cone** that also end in a 1.4mm diameter flat.

<b>C050</b>	TAAB capsule 8mm truncated cone, <b>polyethylene</b>	500
<b>C051</b>	TAAB capsule 8mm truncated cone, <i>polypropylene</i>	500
<b>C052</b>	TAAB capsule 6mm truncated cone, <b>polyethylene</b>	500
<b>C053</b>	TAAB capsule 6mm truncated cone, <i>polypropylene</i>	500
<b>C063</b>	TAAB capsule 8mm truncated pyramid, <b>polyethylene</b>	500
<b>C064</b>	TAAB capsule 8mm truncated pyramid, <i>polypropylene</i>	500
<b>C094</b>	TAAB capsule 8mm flat, <b>polyethylene</b>	500

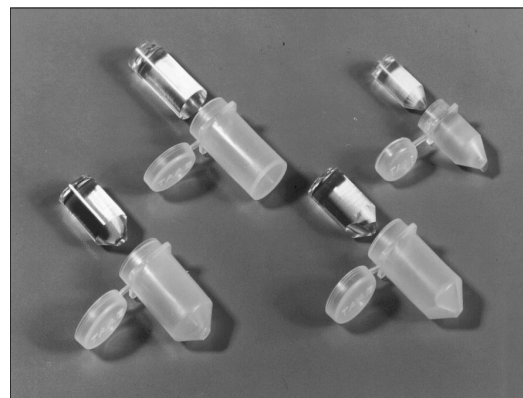

*The flat-ended capsules C094 and C095 are also ideal for storage of specimens and grids.*

## TAAB Capsule Rack

Aluminium pre-numbered rack accommodating 25 TAAB capsules. Designed to permit the TAAB capsule to rest safely on its square flange so preventing the capsule from passing through the holes. This design of rack is not suitable for other types of embedding capsules. The racks are self stacking and suitable for temperatures well in excess of 100°C.

<b>C054</b>	TAAB capsule rack – 8mm capsule	per 5
<b>C055</b>	TAAB capsule rack – 6mm capsule	per 5

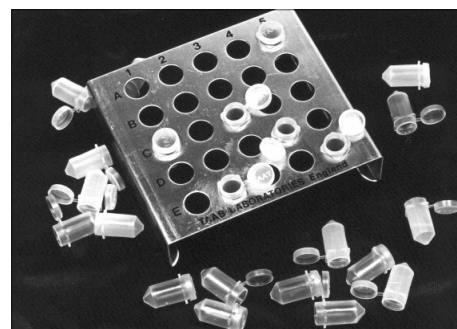

## TAAB Capsule Splitter

Used with a single edge blade to give easy and safe removal of blocks from TAAB capsules, accepts both 8mm and 6mm size capsules. Particularly useful with the harder polypropylene capsules.

<b>C065</b>	TAAB capsule splitter	each
-------------	-----------------------	------

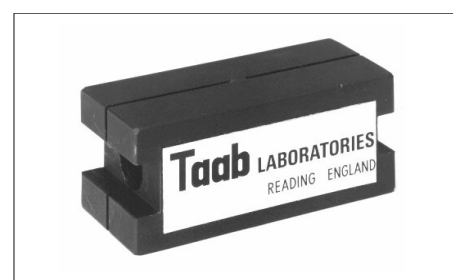

## BEEM Capsules

Available in two shapes, these Polythene capsules have either a truncated pyramid shape ending in a 1mm square tip in 8mm (00) or 5.2mm (3) diameter or with a Bottle-neck (Hemi-hyperbola) tip (rather than the faced tip). Useful for embedding very small or elongated specimens, this shape is only available in the 8mm (00) size.

<b>C056</b>	BEEM 8mm diam. truncated pyramid	100
<b>C056/1</b>	BEEM 8mm diam. truncated pyramid	1000
<b>C057</b>	BEEM 5.2mm diam. truncated pyramid	100
<b>C057/1</b>	BEEM 5.2mm diam. truncated pyramid	1000
<b>C266</b>	BEEM 8mm diam. bottle-neck	100

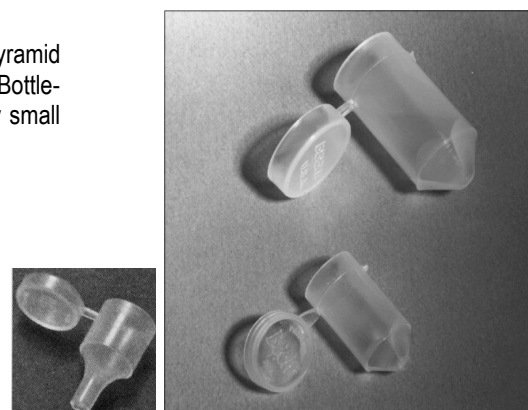

C266

## Gelatine Capsules

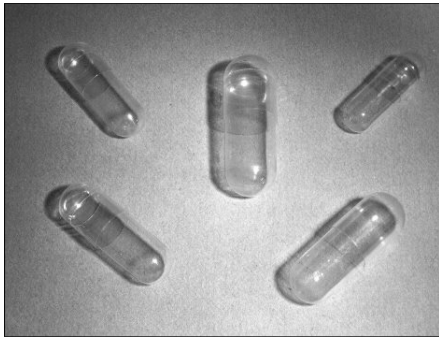

Larger gelatine capsules are available on request - please contact our sales team.

Manufactured from hard colourless gelatine, these capsules are ideal to mould blocks for sectioning, or can be used for grid and specimen storage and transit.

Product code	Capsule size	Diameter mm	Volume ml	Quantity approx.
C086	000	9.50	1.37	100
C086/1	000	9.50	1.37	1000
C087	00	8.50	0.95	100
C087/1	00	8.50	0.95	1000
C088	0	7.00	0.68	100
C088/1	0	7.00	0.68	1000
C089	1	6.50	0.50	100
C089/1	1	6.50	0.50	1000
C090	2	6.00	0.37	100
C090/1	2	6.00	0.37	1000
C091	3	5.50	0.30	100
C091/1	3	5.50	0.30	1000
C092	4	5.00	0.21	100
C092/1	4	5.00	0.21	1000

## Micromoulds

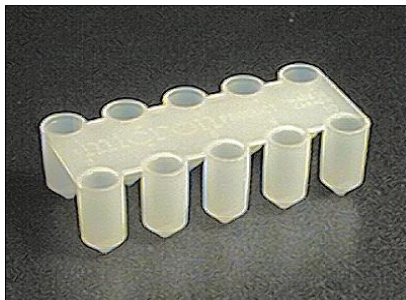

A self supporting polyethylene strips of 10 numbered embedding moulds, each mould produces 8mm diameter (size 00) blocks with a truncated pyramid having a 1mm square end. The mould is open ended with no closure.

C208 Micromoulds 8mm

pack 10 strips

## Microporous Specimen Capsules

These solvent resistant small porous capsules with push-on lids can be used for many processing applications for fragile specimens. The microporous structure allows liquid exchange but the walls retain sufficient reagent to keep specimens moist up to the dehydration stage. The capsules are extremely useful for safely containing biological specimens during processing for Critical Point Drying. Also useful for specimen desiccation procedures. Average pore size 80µm

Internal dimensions: 8mm Ø x 7mm high (with lid fitted)

External dimensions: 10mm Ø x 12mm high (with lid fitted)

C255 Microporous specimen processing capsules with lids pack 10

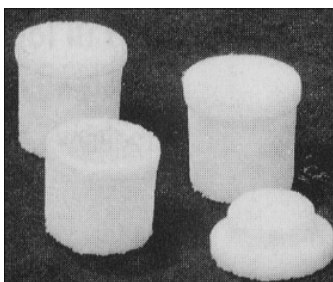

## Leica/LKB Embedding Capsules 'Easy Moulds'

Polyethylene "easy moulds" available in two sizes 5.6mm and 8mm, the tip of each mould is 0.3mm thick and is designed to act as a "window" to orient the specimen before polymerisation. The design of the mould tray allows air to circulate freely around the specimen tip during curing. The mould can be capped when using methacrylates etc by placing another mould on top, and with light pressure seal the capsules completely. The cured blocks will pop out by simply compressing the tip of the mould with your thumb. Each tray has 20 moulds that are numbered for easy reference.

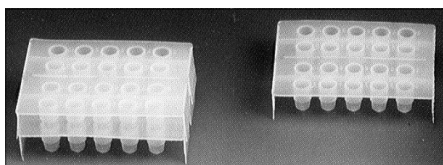

C250 Leica/LKB embedding capsule 5.6mm

50 trays

C251 Leica/LKB embedding capsule 8.0mm

50 trays

## Technovit Specimen Mould

A Polythene mould with removable top and bottom and specimen chamber size of 22mm L x 12mm W x 9mm Deep. V shaped at both ends so it can be used for more than one specimen from the same batch. Outside diameter of final cylinder for clamping in the microtome is 25mm.

T276 Technovit mould pack of 3

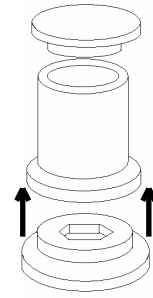

## BEEM Capsule Holder

Specially designed vacuum formed plastic trays to hold 22 capsules. Trays are easily stacked in the TAAB Embedding Oven for polymerisation of resins. Although originally designed to take BEEM capsules, the 8mm tray will accept TAAB Capsules and size 00 gelatine capsules and the 5.2mm tray also accepts size 3 gelatine capsules. The trays are used to hold capsules upright during the resin embedding stage and the small hole in the bottom of each tray cavity allows for illumination from the bottom to assist specimen orientation.

C066 BEEM capsule tray for 8mm capsules each  
 C067 BEEM capsule tray for 5.2mm capsule each

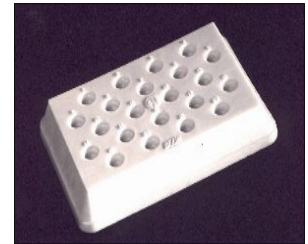

## BEEM Capsule Press

A hand operated press for releasing blocks from BEEM capsules. The block is pushed out safely without any resultant damage, there is an adapter available to convert the press to accept 5.2mm (No. 3) size capsules.

C213 BEEM capsule press 1  
 C213A Press adapter for No. 3 capsules 1

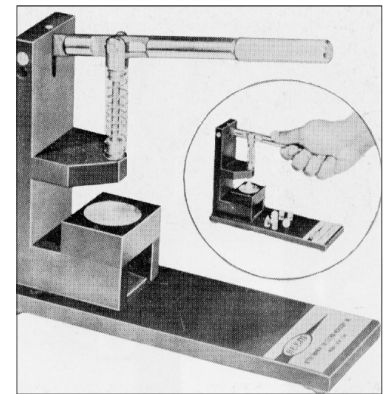

## Blades – Single Edge

GEM extra keen single edge, rigid backed blades 0.009" thick, ideal for sectioning, trimming etc. These blades are available in carbon or stainless steel packed 100 blades in a drawer box or as 10's in a plastic bag.

B054 Single edge grade 2 uncoated carbon steel blades 100  
 B055 Single edge grade 2 uncoated carbon steel blades 1000  
 B056 Single edge grade 1 uncoated stainless steel blades 100  
 B056/2 Single edge grade 1 uncoated stainless steel blades 10

Also available is a **Teflon** coated Grade 2 Blade

B301 Single edge grade 2 Teflon coated carbon steel blade 100

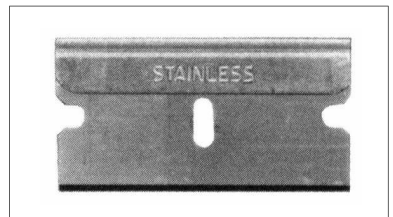

## Blades - Heavy Duty

For those wishing for a more rigid, stronger blade there is a version similar to the B054 which is 0.012" thick and without the end notches giving added strength and rigidity to an already strong and highly acclaimed superior cutting edge.

B146 Single edge heavy duty grade 2 carbon steel blades 100



## Blades – Double Edge

Double edge stainless steel 0.004" blades.

B253 Double edge stainless steel blades 100  
 B253/1 Double edge stainless steel blades 10 x 10

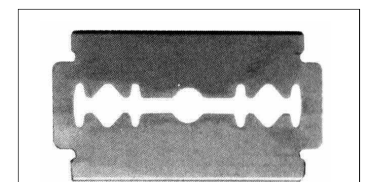

## Blades – GEM in

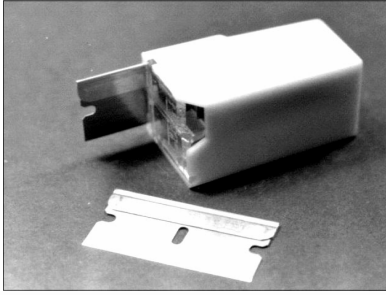

Carbon Steel, 0.009" thick single edge blades packed 10 to a dispenser. The used blades are stored in the bottom of the rigid dispenser for safe disposal.

<b>B147</b>	Single edge blades in dispenser	each
<b>B147/1</b>	Single edge blades in dispenser	pack/12

## Blades - Unbacked

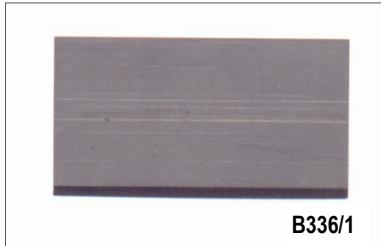

B336/1

Rigid carbon steel unbacked blades ,one **B336/1** has no holes or notches the other **B335** is similar to B054 but without backing.

The **B335** product is supplied in a protective/dispenser container, this is reflected in the product price, after the one-off cost the empty container can be returned for a refill when ordering **B335/RF** or you can refill the dispenser yourself from the 1000 pack.

<b>B335/1</b>	Single edge blade <i>without</i> backing	1000
<b>B335</b>	Single edge blade w/o backing in dispenser	100
<b>B335/RF</b>	Single edge blade w/o backing, refill	100
<b>B336/1</b>	S/edge blade <i>without</i> notches and backing	1000

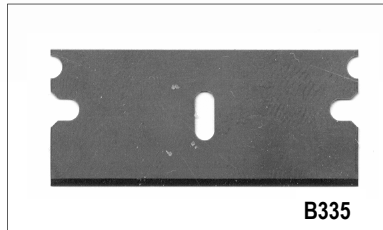

B335

## Blades – Injector Style



Stainless steel single edge blades, ideal for Vibratome and other sectioning applications. Blade length 1.5 inch (38mm), width ¼ inch (6mm) and thickness 0.050 inch (0.12mm). The **B294** product is supplied in a protective/dispenser container. This is returnable and reflected in the initial product price. After the one-off cost, the empty container can be returned for a refill when ordering **B294/RF**.

<b>B294</b>	Blades – injector style stainless steel	100
<b>B294/RF</b>	Blades - injector s/steel refill	100
<b>B294/1</b>	Blades – injector style stainless steel	1000
<b>B210</b>	Blades - injector style <i>platinum</i> coated	100

## HOLDER for Single Edge Blades



This holder will take any of the B054, B055 or B056 blades. The blade is retractable when not in use and provides a safer method of use, keeping fingers further away from the cutting edge when cutting hard materials.

Comes complete with one blade, it is easy to reverse blade to expose a new cutting edge or to refill with a new blade.

<b>B181</b>	Holder for single edge blade	each
-------------	------------------------------	------



## Glass Microspray

Designed to atomise very small volumes of liquid, the spray is valuable in preparing virus and protein suspensions and a wide variety of other particle preparations. The spray is made in glass to facilitate thorough washing and autoclaving. It will operate with as little as 0.2ml of suspension. It normally directs the suspension onto grids lying on a horizontal surface, through a right angled exit tube. A screw joint to the extension permits alternative attachment to a closed vessel for extra protection during dangerous preparations. The blowball attached to the air inlet is valved so that there is no sucking back of vapour from the spray. Spray droplets down to  $\mu\text{m}$  are formed.

- |             |  |          |
|-------------|--|----------|
| <b>M073</b> | Glass microspray, complete   | each     |
|             | spare parts may be purchased separately                                  |          |
| <b>M074</b> | Glass spray with bung  | each     |
| <b>M075</b> | 2-Way valved PVC blowball  | each     |
| <b>M076</b> | PTFE gasket, screwed union and tube with 90° bend for attachment to M074 | set      |
| <b>M077</b> | Spare bungs for spray  | pack/ 10 |

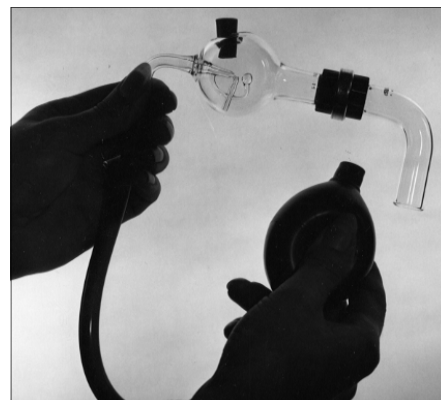

## BEEM Block Holder Module

A small moulded box with clear plastic snap-fit cover. This box holds up to ten size 00 (8mm) blocks in numbered compartments.

- |               |                          |        |
|---------------|--------------------------|--------|
| <b>B103</b>   | BEEM block holder module | each   |
| <b>B103/1</b> | BEEM block holder module | per 10 |

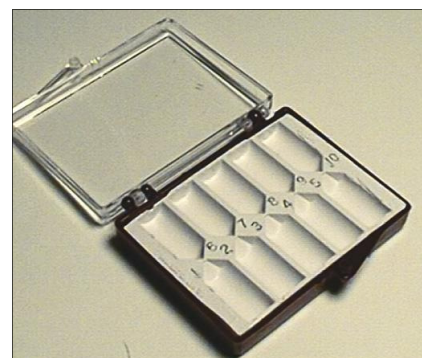

## Microtome Chuck - Flat Embedding Mould

A useful flat embedding chuck suitable for all Reichert and RMC ultramicrotomes. Careful design allows total adjustment of jaws to cope with varying thicknesses of resin blocks.

- |             |   |      |
|-------------|---|------|
| <b>S264</b> | Microtome chuck - flat embedding mould    | each |
|             | <i>Also available for LKB please ask.</i> |      |

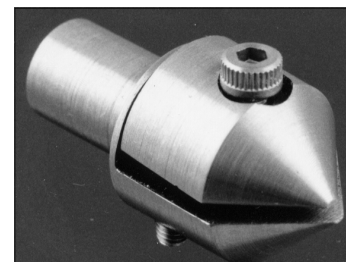

## BEEM Flat Embedding Mould

A virtually transparent polyethylene mould, each cavity is numbered and each unit can produce up to 12 smooth flat polished blocks, size 12mm x 5mm x 3mm deep. The transparent nature of the mould facilitates specimen orientation with bottom illumination. Supplied in a plastic box with hinged lid.

- |               |                           |        |
|---------------|---------------------------|--------|
| <b>E107</b>   | BEEM flat embedding mould | each   |
| <b>E107/1</b> | BEEM flat embedding mould | per 10 |

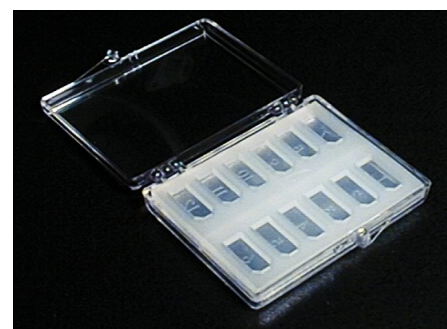

## Silicone Moulds

A range of moulds that give an alternative method of embedding to TAAB or BEEM capsules. Re-usable, ease of block removal, easy to stack, ten numbered impressions are just a few of the obvious advantages. Along with other silicone moulds, these moulds are not recommended for use with some resins and methacrylates. In these and other circumstances – we suggest the use of TAAB's full range of polyethylene and polypropylene capsules.

This range of moulds produce the classical style of blocks in 8mm diameter. TAAB have extended the range to include a flat version with the length of block produced reduced to 9mm long.

- |              |  |      |
|--------------|--|------|
| <b>E076</b>  | TAAB silicone mould, truncated cone    | each |
| <b>E077</b>  | TAAB silicone mould, truncated pyramid | each |
| <b>E078</b>  | TAAB silicone mould, flat              | each |
| <b>E078X</b> | TAAB silicone mould, flat x 9mm long   | each |

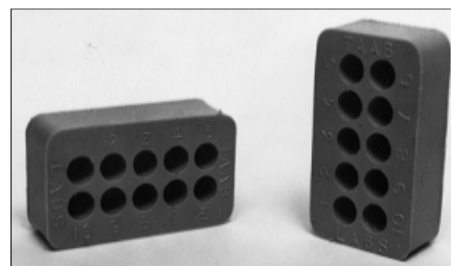

## Embedding Moulds and Stubs

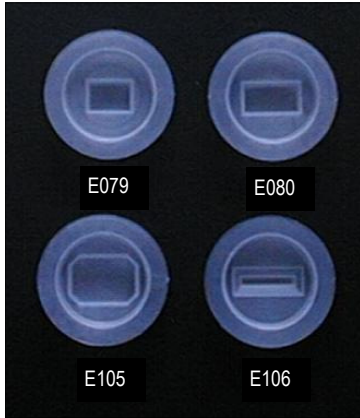

An embedding system producing ready mounted blocks in a choice of **four sizes** for direct mounting to microtomes. The rigid plastic stubs bond to all resins and can be clamped in the microtome on a choice of two diameters, 25mm or 10mm. These stubs are inexpensive, can be written on for reference and are intended to be used as a disposable item. The E092 range of stubs has a deeper 25mm diameter flange to provide more secure clamping in the microtome. The stubs are available in a range of colours for coding of specimens. The polyethylene moulds are individual items which nest in stackable aluminium trays embedding trays each holding up to 6 moulds, which can be any one of the four available mould types 16 x 8 x 5mm deep; 12 x 8 x 5mm deep; 19 x 13 x 5mm deep and 16 x 2 x 5mm deep.

The aluminium trays are durable and with reasonable care will last for years. The moulds may be re-used several times.

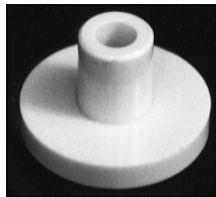

E081

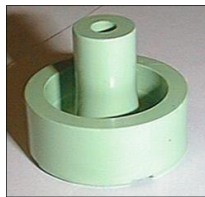

E092

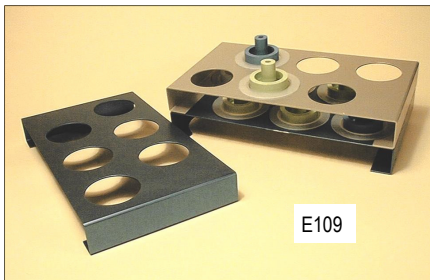

E109

E079	Embedding mould 12mm x 8mm	per 100
E080	Embedding mould 16mm x 8mm	per 100
E105	Embedding mould 19mm x 13mm	per 100
E106	Embedding mould 16mm x 2mm	per 100
E109	Embedding tray	per 10

E081	Embedding stubs – shallow flange – white	per 100
E081/B	Embedding stubs – shallow flange – blue	per 100
E081/G	Embedding stubs – shallow flange – green	per 100
E081/R	Embedding stubs – shallow flange – random colours	per 100
E081/Y	Embedding stubs – shallow flange – yellow	per 100
E092	Embedding stubs – deep flange – white	per 100
E092/B	Embedding stubs – deep flange – blue	per 100
E092/G	Embedding stubs – deep flange – green	per 100
E092/R	Embedding stubs – deep flange – random colours	per 100
E092/Y	Embedding stubs – deep flange – yellow	per 100

## Histological Embedding Moulds

With the routine use of resin embedding in the histological field, there is a demand for convenient moulds to accommodate larger sections. The **four** green silicone rubber moulds each accommodate four referenced blocks, the base in each case being 25 x 25mm. The area containing the material to be sectioned comes in **four** sizes, 10 x 10mm; 10 x 15mm; 10 x 20mm and 10 x 25mm.

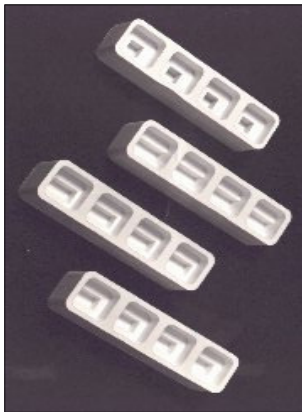

E065	Histological mould 10 x 10mm	each
E066	Histological mould 10 x 15mm	each
E067	Histological mould 10 x 20mm	each
E068	Histological mould 10 x 25mm	each

## Technovit Teflon Histoform Embedding Moulds

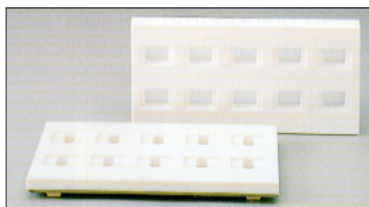

**T393 Histoform S** A Teflon mould giving easy removal of **10** plastic blocks using the Histobloc system. Backed by a heavy steel plate to act as a heat sink and ensure lower curing temperatures within the block. This is particularly pertinent to immunocytochemical work. *Mould cavities* 10mm wide x 16mm high x 6.5mm deep

**T394 Histoform Q** As Histoform S but with *mould cavities* 20mm wide x 16mm high x 10mm deep.

**T405 Histoform N** As above but with *mould cavities* 9mm W x 18mm H x 5mm D.

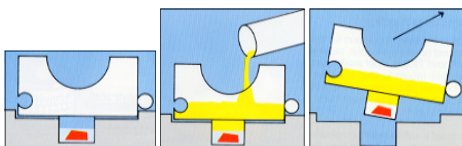

Histoform S



Histoform



**Histobloc** An easily fixed and permanent backing for Histoform specimens that can be clamped into all rotary microtomes without an adapter. Easy to write on and they link together for storage.

**T395** Histobloc mounting blocks for S and Q pack of 100 **T395/N** Histobloc for Histoform N

## Embedding Mould – Round

This green silicone rubber mould has 6 round cavities of 14mm diameter x 3mm deep. Overall size of mould 68mm x 46mm.

**E070** Embedding mould type 'D' each

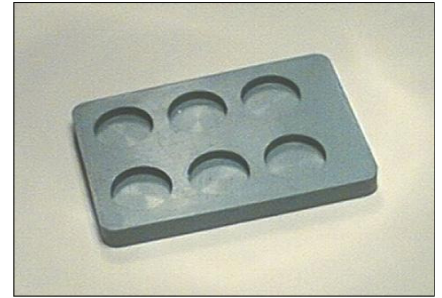

## Embedding Mould – Large Round

A green silicone mould 92mm in diameter, with 10 compartments. Very useful for large or multiple specimen embedding in one segment.

**E108** Embedding mould – large round each



**NEW** – The following silicone rubber moulds are now available in a transparent form, which make them ideal for specimen orientation if transmitted light is used.

## Embedding Mould Large –28 Cavity

A green silicone rubber mould with 20 unmarked cavities 12mm x 6mm 3mm deep with trapezoidal shaped tip at one end, and a further 8 cavities of rectangular shape 3.5mm wide in a variety of lengths of 12mm; 24.5mm and 30mm. Overall size of mould 113mm x 70mm.

**E069** Embedding mould type 'C' each  
**E069/C** Embedding mould type 'C' – Clear each



## Embedding Mould – 21 Cavity

This green silicone rubber mould has 21 flat cavities, each one numbered in relief, mould size 13mm x 4.5mm x 3mm deep. This mould is similar to E061 (type 'A') but for larger specimens. Overall size of mould 69mm x 70mm.

**E071** Embedding mould type 'B' each  
**E071/C** Embedding mould type 'B' – Clear each

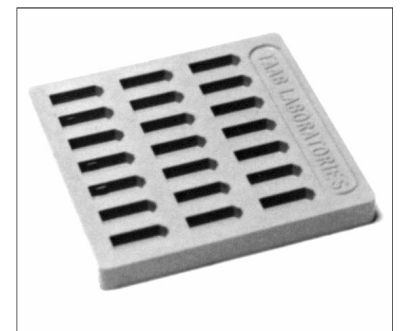



## Double-End Flat Mould



This green silicone rubber mould will produce pre-trimmed trapezoidal flat blocks shaped at both ends. Capacity **20** numbered cavities, the block size produced is 14mm x 6mm x 4mm deep. Overall size of mould is 93 x 62mm.

**E094** Embedding mould type 'E' each  
**E094/C** Embedding mould type 'E' – Clear each

## Flat Embedding Mould – Large

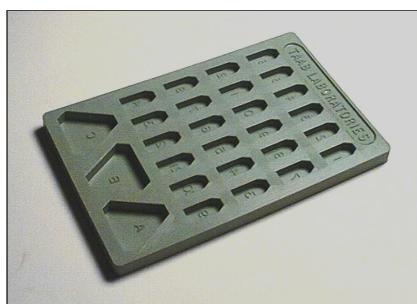

This green silicone rubber mould has **24** self numbered cavities and produces blocks with trapezoidal tip at one end for easy trimming. The produced block is 14mm x 6mm x 4mm deep and the mould also contains **3** special cavities for multiple embedding which can hold **3** samples in each cavity. Overall size of mould 118mm x 78mm.

**E095** Embedding mould type 'F' each

## Small Embedding Mould

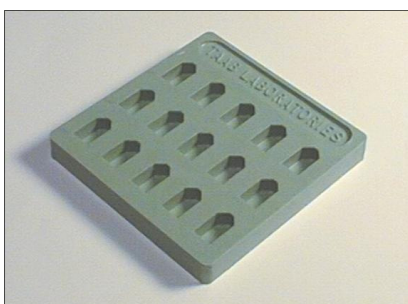

A green silicone rubber mould with **15** unmarked cavities. Specimen blocks measure 11mm x 6mm x 5mm deep, and produces a pre-trimmed trapezoidal shape at one end and a flat end at the other. Overall size of mould 68mm x 68mm.

**E096** Embedding mould type 'G' each  
**E096/C** Embedding mould type 'G' – Clear each

## Dual Section Embedding Mould

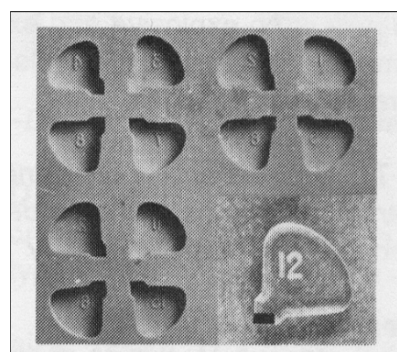

The Chien dual section silicon mould significantly increases the survey area without the necessity for lengthy re-embedding. The mould design allows both transverse and lateral sections to be obtained from the same block. The mould is reusable and produces **16** indexed, sharply defined pre-trimmed blocks that are adaptable to any microtome. Block dimensions 13mm long x 3mm thick.

**E111** Dual section mould each

## Polyethylene Cups



Designed as stoppers, the range of sizes offer an ideal alternative as an inexpensive disposable flat embedding mould.

**C082** Polythene cup 35mm diam. x 22mm deep pack 50  
**C083** Polythene cup 28mm diam. X 18mm deep pack 50  
**C084** Polythene cup 22mm diam. X 16mm deep pack 50  
**C085** Polythene cup 18mm diam. X 14mm deep pack 50



## FIB SEM Mould for Biological Specimens

A silicon rubber mould developed by Cancer Research UK London Laboratories (Dr Lucy Collinson, paper in publication) to minimise FIB erosion time for biological specimens.

This 6 cavity mould is reusable many times if handled with care.

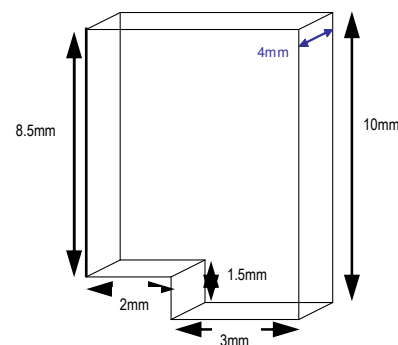

## Disposable Weighing Dish/Boat

### ALUMINIUM

An aluminium weighing dish that is useful for EM pre-embedding procedures, and is also ideal for static-less weighing. The base diameter is 53mm and the depth is 17mm.

**W083** Disposable weighing dish pack 144



### POLYSTYRENE

A high impact polystyrene weighing boat designed to be bent between the fingers to give a funnel shape to facilitate pouring. Available in either black or white with a choice of two sizes.

**W082** Weighing boat 30ml - white 100

**W082/B** Weighing boat 30ml - black 100

**W104** Weighing boat 100ml - white 100

**W104/B** Weighing boat 100ml - black 100



## Millipore Filters

A series of graded filter pads composed of biologically inert mixtures of cellulose acetate and cellulose nitrate and a specially designed Luer fitting filter holder made from polypropylene with a silicone gasket. Available in a range of pore sizes making them suitable for fine filtering of solutions.

**F093** Millipore holder – swinnex 25mm each

**F094** Millipore filters 0.45µm pack 100

**F095** Millipore filters 0.22µm pack 100

*For a comprehensive range of filtering equipment manufactured by Sartorius see Filtration Section.*



## Porous Capsules

Another innovation from TAAB. The capsule is produced in two parts, the base in polyethylene and the wall in porous sintered polyethylene. The capsule allows the easy transfer of specimens from one solution to another without handling or risk of loss. On removal from a solution the “wetted” type capsule drains completely.

**Pore size of wall material is 100 microns.**

The capsule can be supplied wetted for aqueous solutions or non-wetted for non-aqueous solutions. The wetted capsule needs to be re-wetted after about 10 uses to retain its maximum drainage characteristics.

There are two sizes of capsule one of ½” outside diameter and the other of 1” outside diameter.

**C078** Porous capsule – 12.7mmdiam. X 15.7mm deep with lid – wetted 10

**C079** Porous capsule – 12.7mmdiam. X 15.7mm deep – non wetted 10

**W077** Wetting agent 250ml



## Spotting Tile – Porcelain – 12 Cavity

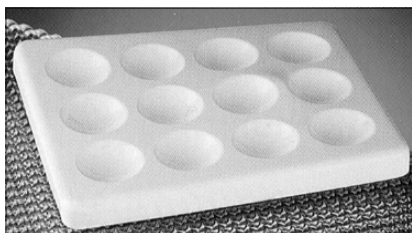

A white glazed porcelain tile, eliminates the problem associated with polypropylene tiles, that of twisting. There are 12 cavities having depression diameter of approximately 12mm and a capacity of 1ml. A high quality spotting tile for EM staining, replica washing, colour reactions etc.

Dimensions; 115mm x 90mm x 12mm thick.

**T178** Spotting tile – porcelain – 12 cavity each

## Spotting Tile – Polypropylene – 12 Cavity

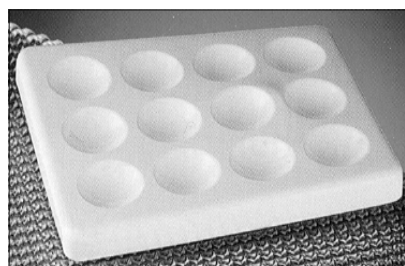

White easily cleaned tile, replacing porcelain. There are 12 cavities of approximately 1ml capacity. An economically priced, high quality, unbreakable spotting tile for EM staining, replica washing, colour reactions.

Dimension; 115mm x 95mm.

**T140** Spotting tile – polypropylene – 12 cavity each

## White Tile

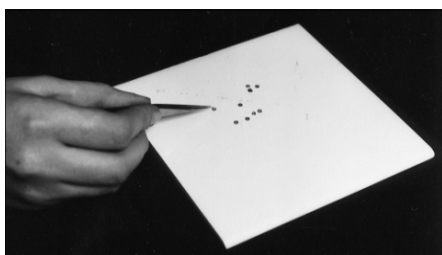

Provides a background of good visibility for handling specimens which are not normally easily seen, for trimming specimens to a size suitable for processing. Easily kept clean, white ceramic 150mm x 150mm.

**T126** White tile – ceramic pack 2

## Spotting Tile – PVC

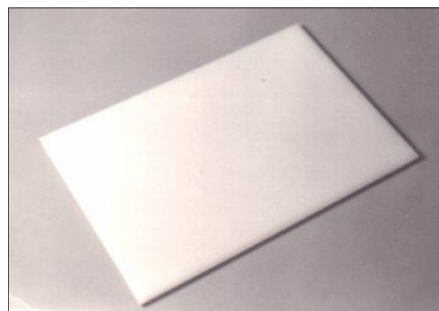

Plain flat, unbreakable white tile, an alternative to ceramic tiles. Dimensions: 100mm x 100mm x 4mm thick.

**T141** Spotting tile PVC pack 2

## Grid Plate

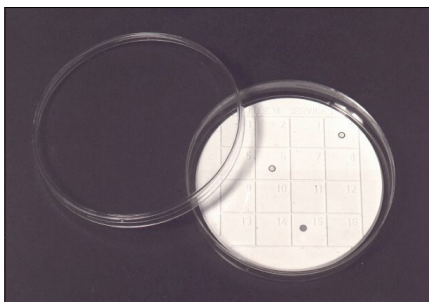

Silicone rubber indexed grid storage and transport plate housed in a polystyrene Petri dish. The ideal way of storing 'working' grids. The grids adhere lightly to the surface of the silicone mould, which eliminates the problem of grids jumping. The grids when required are easily picked up with tweezers. The grid disc are also available separately should you wish to supply your own plastic or glass Petri dishes. Available in sizes to fit 90mm or 50mm diameter Petri dishes.

**G082** Grid plate (85mm) in Petri dish each  
**G082/1** Grid plate (85mm) in Petri dish pack 10  
**G082P** Grid plate (85) – loose pack 10  
**G125** Grid plate (45mm) in Petri dish each  
**G125P** Grid plate (45mm) – loose pack 10

## Grid Transporting Box

For the storage or transport of a greater number of grids, TAAB has introduced the Grid Transporting Box, consisting of an indexed silicone rubber plate housed in a transparent viewing box with hinged lid. The silicone rubber plate is divided into 54 individual compartments of 10mm square, each compartment capable of holding 3 grids. The grids adhere well to the silicone rubber plate and the design of the plate eliminates any possibility of grids migrating from one cell to another. Dimension: 95mm x 70mm x 6mm deep. Each unit comes complete with a record card.

**G117** Grid transporting box each  
**G117/1** Grid transporting box per 10



## Mortar and Pestle

A moulded glass or porcelain mortar and pestle with foot and spout, the bowl diameter of 80mm is ideal for preparing powdered reagents prior to making into solutions.

**M117** Mortar and pestle – glass each  
**M117/P** Mortar and pestle – porcelain each

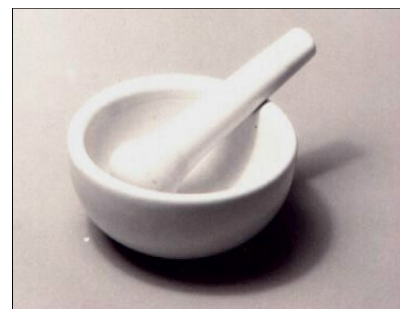

## Stirring Sticks

Flat wooden 5" long disposable sticks, clean smooth finish ideal to mix and stir resins. All quantities are approx.

**S125** Stirring sticks pack 500  
**S125/1** Stirring sticks pack 100

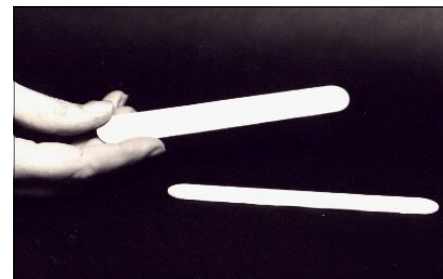

## Stirring Rods

Plastic disposable stirring rods, 120mm long with 25mm long flattened end. Ideal for mixing of samples and solutions, for application of adhesives etc.

**S333** Stirring rods pack 100

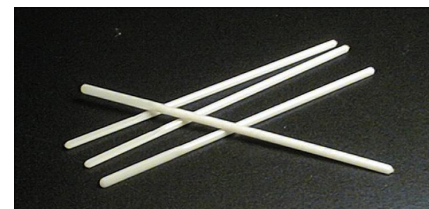

## Dropper Bottles

Hexagonal amber glass bottle fitted with glass dropper, rubber teat and Bakelite cap.

**B096** Dropper bottle – 10ml capacity per 10  
**B343** Dropper bottle - 20ml capacity per 10







## Pasteur Pipette – Glass

Glass short form 150mm long, non-sterile pipettes.

**P050** Pasteur pipette – glass

box 250

**P052** Pipette bulb – 2ml capacity

pack 10

## Pasteur Pipette – Polyethylene

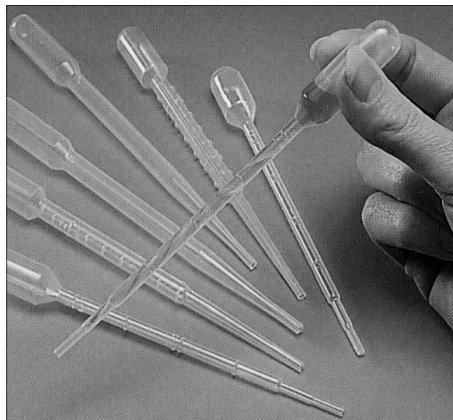

Disposable polyethylene pipettes with integral bulb that can be used to withdraw up to 3.5ml in one squeeze. The range provided by TAAB offer flexibility of use from handling viscous materials to dispensing very minute volumes of liquid. The use of plastic pipettes is very important to avoid any possibility of glass fragments contaminating embedded blocks that could damage a diamond knife when sectioning. Although the quantities shown below are box quantities it is possible that smaller pack sizes are available – please refer to price list.

Non Sterile - Bulk pack - 500 box						
Product No	Length mm	Drop size ul	Drops/ml	Feature	Subdivision	Graduated
<b>P053</b>	152	45.5	22	Graduated	0.5ml	3ml
<b>P239</b>	152	40	25	Thin stem	—	—
<b>P240</b>	150	20	50	Microtip	—	—
<b>P294</b>	152	40	25	Graduated	0.25ml	1ml
Sterile - Individually wrapped - 250 box						
<b>P241</b>	152	40	25	Thin stem	—	—
<b>P242</b>	152	45.5	22	Graduated	0.5ml	3ml

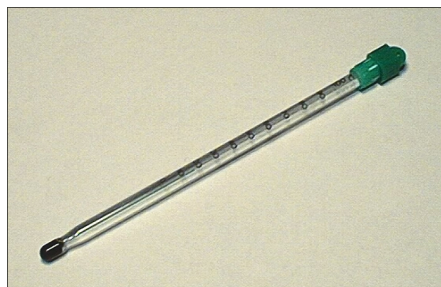

## Stirring Thermometer

A short form robust *total immersion* stirring thermometer, with a **reinforced bulb**. The thermometer is only 150mm long and will stand in an empty 50ml beaker without causing it to fall over. Calibrated in degrees Celsius on white background, with a range of -10 to 110°C.

**T167** Thermometer – stirring

each

## Waterproof Stirring Thermometer

A cost-effective instrument designed for simplicity and accuracy.

An ideal instrument for liquid and semi-solid sampling. The probe protection sheath has a vent hole in the end so that the instrument can be used as a stirrer yet still display the sample temperature. The sheath can be connected to the head of the unit and used as a head extension.

- Rated waterproof to IP-65 standards.
- Membrane keypad features LCD and function buttons
- Selectable between °C and °F
- Polycarbonate body and vented sheath
- Data Hold function retains the displayed value allowing the removal of the probe from the sample.
- 125mm length x 4mm Diam. stainless steel probe with pointed tip
- The sensor is located in the bottom 10mm of the probe.
- Auto power off function activates after 10 minutes to preserve battery life.

### Technical Specification;

Range °C/ °F -50.0 to 150.0°C / -58 to 302°F

Resolution 0.1 (-19.9 to 199.9), 1.0 (others)

Accuracy °C/ °F ± 0.5°C / ±1.8°F

Batteries/life 1 x 1.5v PL-13 button cell battery/500 hours approx.

Dimensions (w x d x h), mm 230 x 20 x 18 weight; 36gm

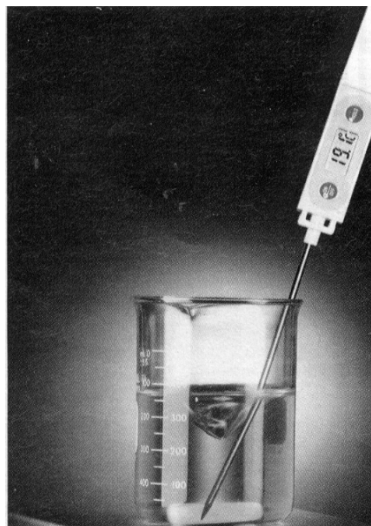



## Petri Dish – Polystyrene

Clear plastic disposable dishes, 90mm diameter x 12mm deep. Produced under sterile aseptic condition, comply with BS611 part 2 and can be used in automatic plate pouring machines

Product	Description	Diam. x	Quantity
<b>Circular</b>		<b>Depth mm</b>	
P051	Triple vent	90 x 12	100
P250	2 Compartment, vented	90 x 12	100
P251	3 Compartment, vented	90 x 12	100
<b>Square</b>			
P297	No vent	100 x 18	120
P298	Repli-dish with 25 - 18 x 18m m	100 x 18	120
	com partments each approx		
	1ml capacity		

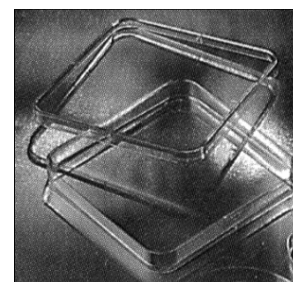
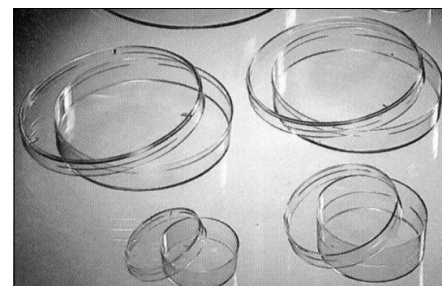

## Petri Dish – Pyrex

A range of 20mm deep glass Petri dishes with 15mm deep covers, available singly.

Product	Description	Base Diam.	Cover Diam.	Quantity
<b>Circular</b>		<b>x Depth, mm</b>	<b>x Depth, mm</b>	
P224	60 x 20	54.5x 20	55 x 15	1
P225	80 x 20	74 x 20	75 x 15	1
P226	100 x 20	94 x 20	95 x 15	1



## Petri Dish – Polypropylene Microwave Compatible

Polypropylene Petri dishes 50mm ID x 15mm high. A clear, sturdy Petri dish suitable for microwave applications.

**P364** Polypropylene Petri dish 50 x 15mm pack of 100



## Filter Papers

Qualitative general purpose paper 0.18mm thickness.

P227	Filter paper No1, 90mm diameter	box 100
P228	Filter paper No1, 125mm diameter	box 100
P229	Filter paper No1, 55mm diameter	box 100
P295	Filter paper No1, 70mm diameter	box 100



## Forceps - Membrane Filters

Membrane filters should only be handled with suitable forceps in order to avoid contamination, which can result from hand contact. These stainless steel forceps have smooth, flat tips. They are autoclavable and can be flamed.

**T169** Forceps, stainless steel, membrane filters each

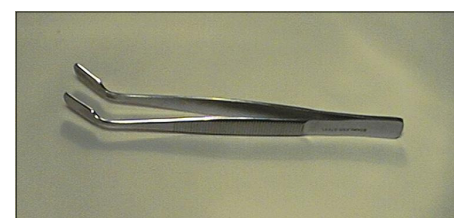

## Petri Dish Stand

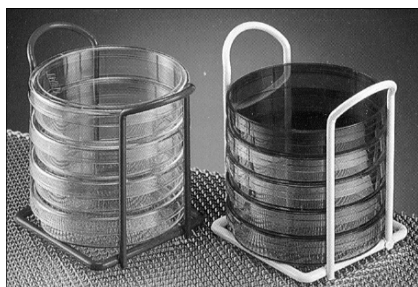

These useful stands will hold up to six 90mm Petri dishes. Manufactured from epoxy coated steel, dispenses 90mm Petri dishes from the base by gravity feed. Fully autoclavable and ideal for small batch incubation. The stands are available in seven different colours for easy batch coding.

<b>P243</b>	Petri dish stand – white	each
<b>P244</b>	Petri dish stand – red	each
<b>P245</b>	Petri dish stand – blue	each
<b>P246</b>	Petri dish stand – black	each
<b>P249</b>	Petri dish stand – grey	each

## Plasticine



Soft moulding compound. In packs of 500g.

<b>P234</b>	Plasticine – blue	each
<b>P235</b>	Plasticine – white	each
<b>P236</b>	Plasticine – red	each
<b>P237</b>	Plasticine – grey	each

## Melinex Film

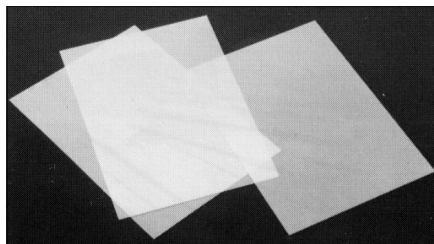

Ideal substrate for growing cell cultures which later can then be incorporated into blocks.

Supplied as 10 x A5 sheets of Melinex, thickness 175µm.

<b>M363</b>	Melinex film - A5	pack 10
-------------	-------------------	---------

## Weighing Paper

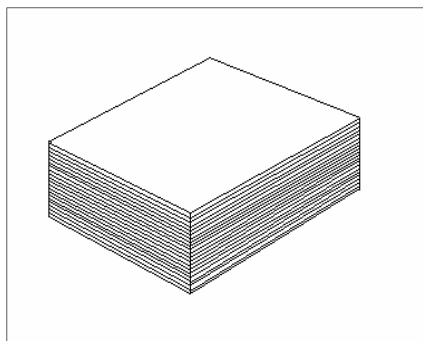

A special paper with a glossy surface which makes it very suitable for weighing powders.

Dimensions are 100mm x 100mm

<b>W105</b>	Weighing paper 100mm x 100mm.	pack 1000
-------------	-------------------------------	-----------

## Wash Bottles - Oval

Oval Polythene wash bottles for general cleaning applications. Slight pressure only is required to dispense liquid. The semi-flexible jet can be angled in any direction giving a better reach than that of the bottles with integral jet.

<b>B213</b>	Wash bottle oval 250ml	pack 5
<b>B214</b>	Wash bottle oval 500ml	pack 5



## Wash Bottles

With integrally moulded tube and separate plain cap. Squared oval shape for stability and easy grip.

- B075** Wash bottle 250ml capacity each  
**B076** Wash bottle 500ml capacity each



## Wash Bottles - Wide Neck - Printed

A vented washbottle for **safer** handling of volatile solvents. The round shape wide neck bottle has a two-way valve mechanism below the nozzle which is claimed stops the build-up of solvent vapour pressure - but closes to allow solvent to be dispensed in the normal way.

The venting stops the problem of solvent drips. Printed with a variety of solvent labels including a blank for customers use.

Water bottles are **without** valve mechanism.

<b>White</b>	"Deionised Water"	<b>Green</b>	"Methanol"
<b>White</b>	"Distilled Water"	<b>Blue</b>	"Isopropanol"
<b>White</b>	"Water"	<b>Yellow</b>	"IMS"
<b>Red</b>	"Acetone"	<b>Orange</b>	"Ethanol"
<b>White</b>	"Blank"		



- |             |                               |      |             |                               |      |
|-------------|-------------------------------|------|-------------|-------------------------------|------|
| <b>B216</b> | Wash bottle 250ml Deion/Water | each | <b>B226</b> | Wash bottle 250ml Isopropanol | each |
| <b>B217</b> | Wash bottle 500ml Deion/Water | each | <b>B227</b> | Wash bottle 500ml Isopropanol | each |
| <b>B218</b> | Wash bottle 250ml Dist/Water  | each | <b>B228</b> | Wash bottle 250ml IMS         | each |
| <b>B219</b> | Wash bottle 500ml Dist/Water  | each | <b>B230</b> | Wash bottle 250ml Ethanol     | each |
| <b>B220</b> | Wash bottle 250ml Water       | each | <b>B231</b> | Wash bottle 500ml Ethanol     | each |
| <b>B221</b> | Wash bottle 500ml Water       | each | <b>B232</b> | Wash bottle 250ml Blank       | each |
| <b>B222</b> | Wash bottle 250ml Acetone     | each | <b>B233</b> | Wash bottle 500ml Blank       | each |
| <b>B223</b> | Wash bottle 500ml Acetone     | each |             |                               |      |
| <b>B224</b> | Water bottle 250ml Methanol   | each |             |                               |      |
| <b>B225</b> | Water bottle 500ml Methanol   | each |             |                               |      |

## Pocket Balance

A pocket balance in credit-card format. The draughtguard over the weighing area and display, protects the balance and also serves as a weighing pan.

### Specification:

Capacity	100gms
Readability/accuracy	0.1gm/±0.1gm
Operating temperatures	+15° to +35°C
Weighing area	65 x 50mm
Batteries	2 x 3V CR2032 (included)
Dimensions	105 x 65 x 8mm
Weight	200gms



- B564** Credit card size pocket balance 100gms



## Sartorius Analytical & Precision Balances

The "Talent" Series of Affordable Weighing Technology

Economically priced yet retaining the Sartorius high quality. **19 models** - one design. **Three analytical balances** with capacities of 60g, 120g, and 210g respectively and **16 precision balances** ranging from the top model with 3,100g capacity and 0.01g readability to the high-capacity model featuring 12Kg weighing capacity. **All** are dependable and accurate

**Ease of use is guaranteed.** Just set them up, switch on, and start weighing.

**Built-in Application Software.** Various programs as standard to make to make routine work easy. Weighing in percent, net total formulation, weighn averaging/dynamic weighing, counting and mass unit conversion.

### Selection Chart



Design 1

#### Specifications

Model	Read-ability [mg]	Weighing Capacity [g]	Repeat-ability [ $\leq \pm$ mg]	Linearity [ $\leq \pm$ mg]	Response Time average [ $\leq$ s]	Weighing Pan [mm]	Design
-------	-------------------	-----------------------	---------------------------------	----------------------------	-----------------------------------	-------------------	--------

#### Analytical Balances

TE214S	0.1	210	0.0001	0.0002	3	Ø 90	1
TE124S	0.1	120	0.0001	0.0002	3	Ø 90	1
TE64	0.1	60	0.0001	0.0002	3	Ø 90	1



Design 2

#### Precision Balances

TE313S	0.001	310	0.001	0.002	2.5	Ø 100	2
TE313S-DS*	0.001	310	0.001	0.002	2.5	Ø 100	1
TE153S	0.001	150	0.0015	0.003	2.5	Ø 100	2
TE153S-DS*	0.001	150	0.0015	0.003	2.5	Ø 100	1
TE3102S	0.01	3,100	0.01	0.02	2.5	174 × 143	4
TE1502S	0.01	1,500	0.015	0.03	2.5	174 × 143	4
TE612	0.01	610	0.01	0.02	2	Ø 116	3
TE412	0.01	410	0.01	0.02	2	Ø 116	3
TE212	0.01	210	0.01	0.02	2	Ø 116	3
TE6101	0.1	6,100	0.1	0.2	2	174 × 143	4
TE4101	0.1	4,100	0.1	0.2	2	174 × 143	4
TE2101	0.1	2,100	0.1	0.2	1.5	174 × 143	4
TE601	0.1	610	0.1	0.2	1.5	174 × 143	4
TE12000	1	12,000	1	2	1.5	174 × 143	4
TE6100	1	6,100	1	2	1.5	174 × 143	4
TE4100	1	4,100	1	2	1.5	174 × 143	4



Design 3

\* With analytical balance draft shield



Design 4