

Mini Vacuum Pumps



Portable bench-top models for a multitude of laboratory uses. Single and twin head diaphragm vacuum pumps/compressors.

These **low cost, high performance** mini pumps provide a clean evacuation and transfer of air and gases giving a long working life through stress optimised KNF structured diaphragms.

Every model has the following features:

- Contamination free pumping of air and gases
- Extremely quiet and smooth running
- Can be used as vacuum pump or compressor
- High tolerance of both vapour and condensate
- Completely portable
- Maintenance free
- Simple operation
- Totally oil free operation

Maximum permissible gas and ambient temp. 40°C
Standard motor 230v 50Hz, others on request.

Units are available with Nitrile diaphragms for standard use, for corrosion resistance pumps **V078KT** and **V079KT** are available with Teflon diaphragms.

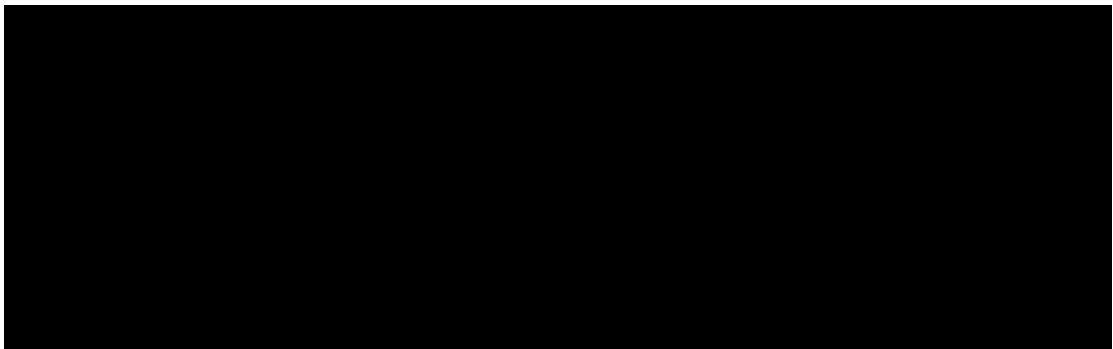

Accessories

V082 Filter/silencer **V083** Water trap **V084** Pressure gauge
V085 Vacuum gauge **V086** Fine control valve

Service kits also available

Starter Kits for Technovit Plastic LM Embedding

The Histotechnic cold curing plastic embedding systems developed by Kulzer in collaboration with well-known scientists are available to beginners as starter kits. The 7100 kit was specially developed for routine procedures in Life sciences and 8100 for immunocytochemical studies. The kits offer low toxicity and outstanding results even for the beginner.

7100 Kit

500ml Technovit 7100	1 piece Histoknife holder	100 pieces Histobloc
5 x 1g hardener I	100 pieces Histoknife H	1 piece Histoform S or Q
40ml hardener II	100g Technovit 3040	80ml Technovit 3040

T221 Histotechnic set 7100 in presentation case

8100 Kit

500ml Technovit 8100	1 piece Histoknife holder	1 piece Histoform S or Q
5 x 0.6g hardener I	100 pieces Histoknife H	80ml Technovit 3040
30ml hardener II	100g Technovit 3040	closing devices
500 cover foils	100 pieces Histobloc	

T222 Histotechnic set 8100 in presentation case



TAAB Embedding Capsules

TAAB manufactures an extensive range of high quality, low cost embedding capsules with airtight snap-on integral caps. These capsules are available in 8mm and 6mm diameter, **polyethylene** (soft) for low temperature curing up to 75°C, or **polypropylene** (hard) for high temperature curing up to 100°C, which can also be autoclaved. Three tip designs to choose from to produce 8mm diameter blocks with **truncated cone** that ends in a 1.4mm diameter flat, a **truncated pyramid** having a 1mm square end and a **full flat ended** block and 6mm diameter blocks with truncated **cone** that also end in a 1.4mm diameter flat.

C050	TAAB capsule 8mm truncated cone, polyethylene	500
C051	TAAB capsule 8mm truncated cone, <i>polypropylene</i>	500
C052	TAAB capsule 6mm truncated cone, polyethylene	500
C053	TAAB capsule 6mm truncated cone, <i>polypropylene</i>	500
C063	TAAB capsule 8mm truncated pyramid, polyethylene	500
C064	TAAB capsule 8mm truncated pyramid, <i>polypropylene</i>	500
C094	TAAB capsule 8mm flat, polyethylene	500
C095	TAAB capsule 8mm flat, <i>polypropylene</i>	500

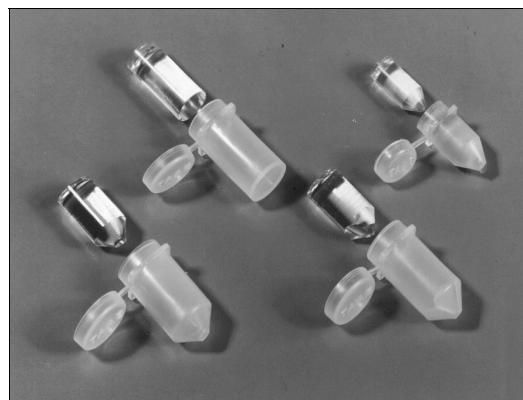

The flat-ended capsules C094 and C095 are also ideal for storage of specimens and grids.

TAAB Capsule Rack

Aluminium pre-numbered rack accommodating 25 TAAB capsules. Designed to permit the TAAB capsule to rest safely on its square flange so preventing the capsule from passing through the holes. This design of rack is not suitable for other types of embedding capsules. The racks are self stacking and suitable for temperatures well in excess of 100°C.

C054	TAAB capsule rack – 8mm capsule	per 5
C055	TAAB capsule rack – 6mm capsule	per 5

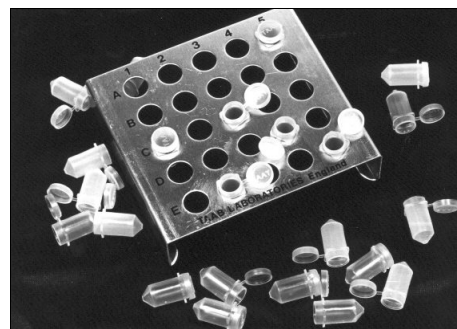

TAAB Capsule Splitter

Used with a single edge blade to give easy and safe removal of blocks from TAAB capsules, accepts both 8mm and 6mm size capsules. Particularly useful with the harder polypropylene capsules.

C065	TAAB capsule splitter	each
-------------	-----------------------	------

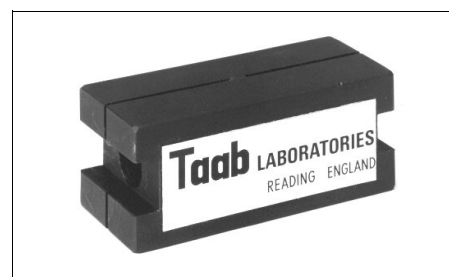

BEEM Capsules

Available in two shapes, these Polythene capsules have either a truncated pyramid shape ending in a 1mm square tip in 8mm (00) or 5.2mm (3) diameter or with a Bottle-neck (Hemi-hyperbola) tip (rather than the faced tip). Useful for embedding very small or elongated specimens, this shape is only available in the 8mm (00) size.

C056	BEEM 8mm diam. truncated pyramid	100
C056/1	BEEM 8mm diam. truncated pyramid	1000
C057	BEEM 5.2mm diam. truncated pyramid	100
C057/1	BEEM 5.2mm diam. truncated pyramid	1000
C266	BEEM 8mm diam. bottle-neck	100

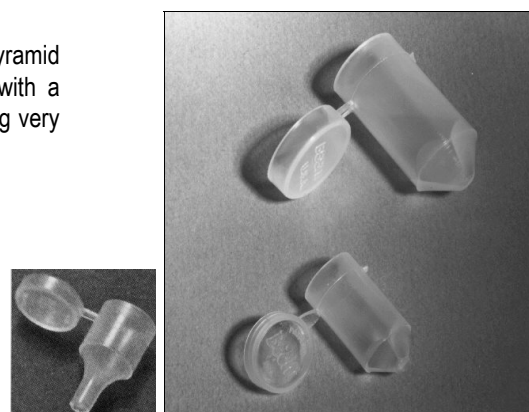

C266

Gelatine Capsules

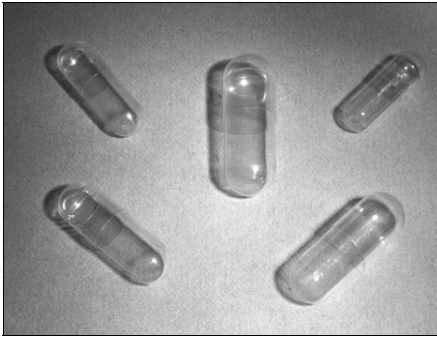

Larger gelatine capsules are available on request - please contact our sales team.

Manufactured from hard colourless gelatine, these capsules are ideal to mould blocks for sectioning, or can be used for grid and specimen storage and transit.

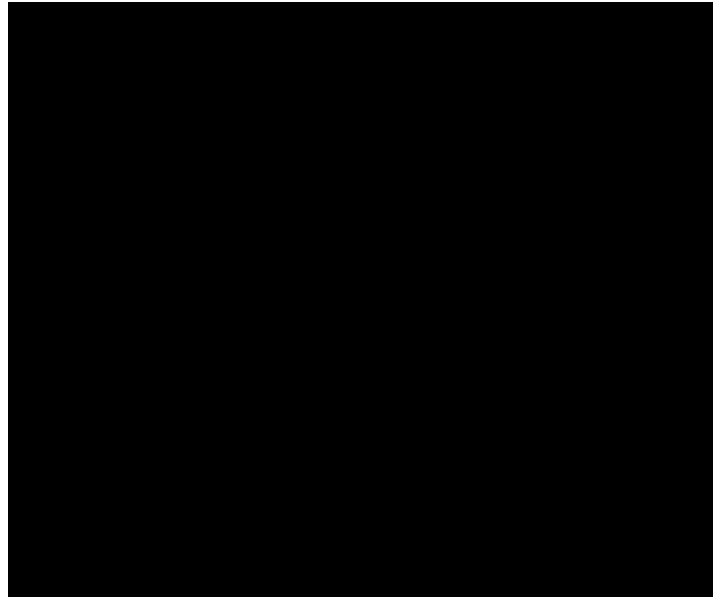

Micromoulds

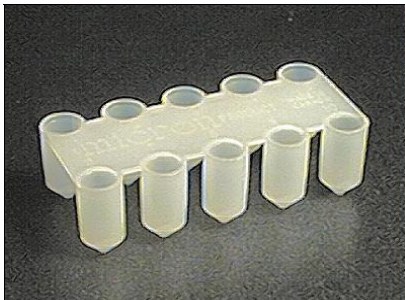

A self supporting polyethylene strips of 10 numbered embedding moulds, each mould produces 8mm diameter (size 00) blocks with a truncated pyramid having a 1mm square end. The mould is open ended with no closure.

C208 Micromoulds 8mm

pack 10 strips

Microporous Specimen Capsules

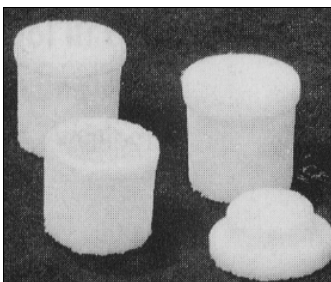

These solvent resistant small porous capsules with push-on lids can be used for many processing applications for fragile specimens. The microporous structure allows liquid exchange but the walls retain sufficient reagent to keep specimens moist up to the dehydration stage. The capsules are extremely useful for safely containing biological specimens during processing for Critical Point Drying. Also useful for specimen desiccation procedures. Average pore size 80µm

Internal dimensions: 8mm Ø x 7mm high (with lid fitted)

External dimensions: 10mm Ø x 12mm high (with lid fitted)

C255 Microporous specimen processing capsules with lids pack 10

Leica/LKB Embedding Capsules 'Easy Moulds'

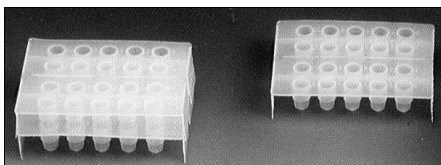

Polyethylene "easy moulds" available in two sizes 5.6mm and 8mm, the tip of each mould is 0.3mm thick and is designed to act as a "window" to orient the specimen before polymerisation. The design of the mould tray allows air to circulate freely around the specimen tip during curing. The mould can be capped when using methacrylates etc by placing another mould on top, and with light pressure seal the capsules completely. The cured blocks will pop out by simply compressing the tip of the mould with your thumb. Each tray has 20 moulds that are numbered for easy reference.

C250 Leica/LKB embedding capsule 5.6mm

50 trays

C251 Leica/LKB embedding capsule 8.0mm

50 trays

Technovit Specimen Mould

A Polythene mould with removable top and bottom and specimen chamber size of 22mm L x 12mm W x 9mm Deep. V shaped at both ends so it can be used for more than one specimen from the same batch. Outside diameter of final cylinder for clamping in the microtome is 25mm.

T276 Technovit mould pack of 3

BEEM Capsule Holder

Specially designed vacuum formed plastic trays to hold 22 capsules. Trays are easily stacked in the TAAB Embedding Oven for polymerisation of resins. Although originally designed to take BEEM capsules, the 8mm tray will accept TAAB Capsules and size 00 gelatine capsules and the 5.2mm tray also accepts size 3 gelatine capsules. The trays are used to hold capsules upright during the resin embedding stage and the small hole in the bottom of each tray cavity allows for illumination from the bottom to assist specimen orientation.

C066 BEEM capsule tray for 8mm capsules each
 C067 BEEM capsule tray for 5.2mm capsule each

BEEM Capsule Press

A hand operated press for releasing blocks from BEEM capsules. The block is pushed out safely without any resultant damage, there is an adapter available to convert the press to accept 5.2mm (No. 3) size capsules.

C213 BEEM capsule press 1
 C213A Press adapter for No. 3 capsules 1

Blades – Single Edge

GEM extra keen single edge, rigid backed blades 0.009" thick, ideal for sectioning, trimming etc. These blades are available in carbon or stainless steel packed 100 blades in a drawer box or as 10's in a plastic bag.

B054 Single edge grade 2 uncoated carbon steel blades 100
 B055 Single edge grade 2 uncoated carbon steel blades 1000
 B056 Single edge grade 1 uncoated stainless steel blades 100
 B056/2 Single edge grade 1 uncoated stainless steel blades 10

Also available is a **Teflon** coated Grade 2 Blade
 B301 Single edge grade 2 Teflon coated carbon steel blade 100

Blades - Heavy Duty

For those wishing for a more rigid, stronger blade there is a version similar to the B054 which is 0.012" thick and without the end notches giving added strength and rigidity to an already strong and highly acclaimed superior cutting edge.

B146 Single edge heavy duty grade 2 carbon steel blades 100

Blades – Double Edge

Double edge stainless steel 0.004" blades.

B253 Double edge stainless steel blades 100
 B253/1 Double edge stainless steel blades 10 x 10

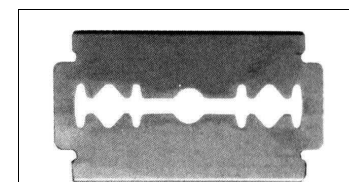
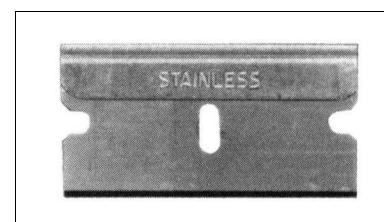
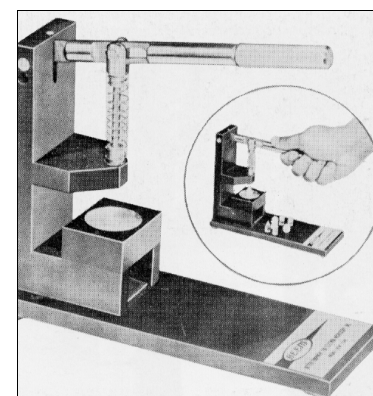
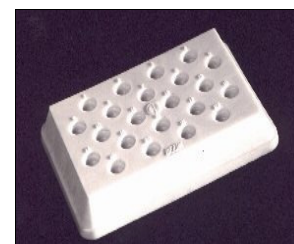
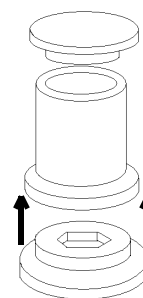

Blades – GEM in Dispenser

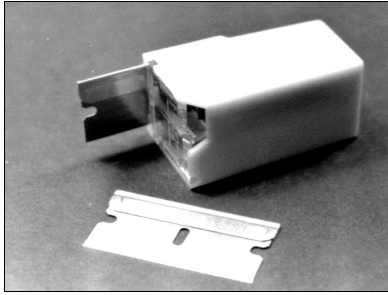

Carbon Steel, 0.009" thick single edge blades packed 10 to a dispenser. The used blades are stored in the bottom of the rigid dispenser for safe disposal.

B147	Single edge blades in dispenser	each
B147/1	Single edge blades in dispenser	pack/12

Blades - Unbacked

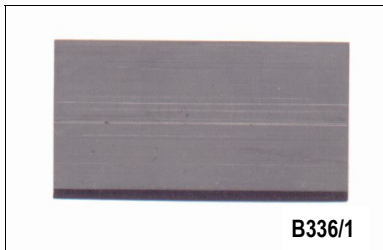

B336/1

Rigid carbon steel unbacked blades ,one **B336/1** has no holes or notches the other **B335** is similar to B054 but without backing.

The **B335** product is supplied in a protective/dispenser container, this is reflected in the product price, after the one-off cost the empty container can be returned for a refill when ordering **B335/RF** or you can refill the dispenser yourself from the 1000 pack.

B335/1	Single edge blade <i>without</i> backing	1000
B335	Single edge blade w/o backing in dispenser	100
B335/RF	Single edge blade w/o backing, refill	100
B336/1	S/edge blade <i>without</i> notches and backing	1000

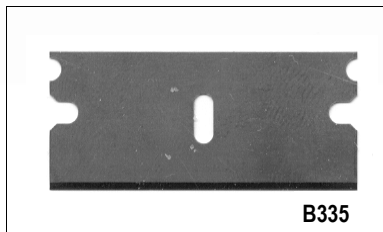

B335

Blades – Injector Style

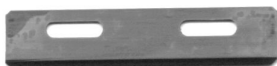

Stainless steel single edge blades, ideal for Vibratome and other sectioning applications. Blade length 1.5 inch (38mm), width ¼ inch (6mm) and thickness 0.050 inch (0.12mm). The **B294** product is supplied in a protective/dispenser container. This is returnable and reflected in the initial product price. After the one-off cost, the empty container can be returned for a refill when ordering **B294/RF**.

B294	Blades – injector style stainless steel	100
B294/RF	Blades - injector s/steel refill	100
B294/1	Blades – injector style stainless steel	1000
B210	Blades - injector style <i>platinum</i> coated	100

HOLDER for Single Edge Blades



This holder will take any of the B054, B055 or B056 blades. The blade is retractable when not in use and provides a safer method of use, keeping fingers further away from the cutting edge when cutting hard materials.

Comes complete with one blade, it is easy to reverse blade to expose a new cutting edge or to refill with a new blade.

B181	Holder for single edge blade	each
-------------	------------------------------	------

Glass Microspray

Designed to atomise very small volumes of liquid, the spray is valuable in preparing virus and protein suspensions and a wide variety of other particle preparations. The spray is made in glass to facilitate thorough washing and autoclaving. It will operate with as little as 0.2ml of suspension. It normally directs the suspension onto grids lying on a horizontal surface, through a right angled exit tube. A screw joint to the extension permits alternative attachment to a closed vessel for extra protection during dangerous preparations. The blowball attached to the air inlet is valved so that there is no sucking back of vapour from the spray. Spray droplets down to μm are formed.

- | | | |
|-------------|--|----------|
| M073 | Glass microspray, complete | each |
| | spare parts may be purchased separately | |
| M074 | Glass spray with bung | each |
| M075 | 2-Way valved PVC blowball | each |
| M076 | PTFE gasket, screwed union and tube with 90° bend for attachment to M074 | set |
| M077 | Spare bungs for spray | pack/ 10 |

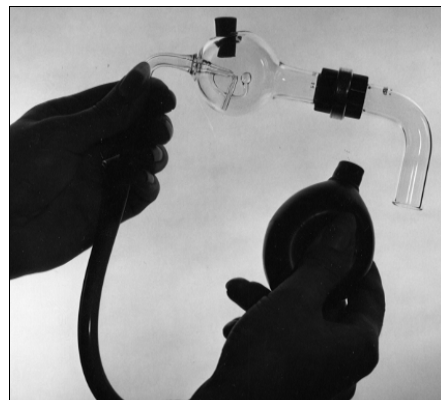

BEEM Block Holder Module

A small moulded box with clear plastic snap-fit cover. This box holds up to ten size 00 (8mm) blocks in numbered compartments.

- | | | |
|---------------|--------------------------|--------|
| B103 | BEEM block holder module | each |
| B103/1 | BEEM block holder module | per 10 |

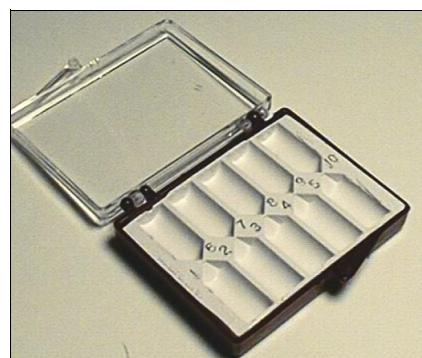

Microtome Chuck - Flat Embedding Mould

A useful flat embedding chuck suitable for all Reichert and RMC ultramicrotomes. Careful design allows total adjustment of jaws to cope with varying thicknesses of resin blocks.

- | | | |
|-------------|---|------|
| S264 | Microtome chuck - flat embedding mould | each |
| | <i>Also available for LKB please ask.</i> | |

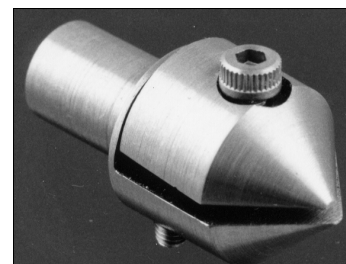

BEEM Flat Embedding Mould

A virtually transparent polyethylene mould, each cavity is numbered and each unit can produce up to 12 smooth flat polished blocks, size 12mm x 5mm x 3mm deep. The transparent nature of the mould facilitates specimen orientation with bottom illumination. Supplied in a plastic box with hinged lid.

- | | | |
|---------------|---------------------------|--------|
| E107 | BEEM flat embedding mould | each |
| E107/1 | BEEM flat embedding mould | per 10 |

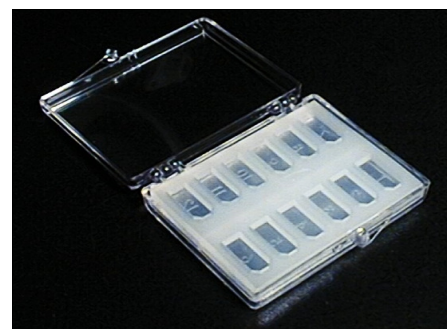

Silicone Moulds

A range of moulds that give an alternative method of embedding to TAAB or BEEM capsules. Re-usable, ease of block removal, easy to stack, ten numbered impressions are just a few of the obvious advantages. Along with other silicone moulds, these moulds are not recommended for use with some resins and methacrylates. In these and other circumstances – we suggest the use of TAAB's full range of polyethylene and polypropylene capsules.

This range of moulds produce the classical style of blocks in 8mm diameter. TAAB have extended the range to include a flat version with the length of block produced reduced to 9mm long.

- | | | |
|--------------|--|------|
| E076 | TAAB silicone mould, truncated cone | each |
| E077 | TAAB silicone mould, truncated pyramid | each |
| E078 | TAAB silicone mould, flat | each |
| E078X | TAAB silicone mould, flat x 9mm long | each |

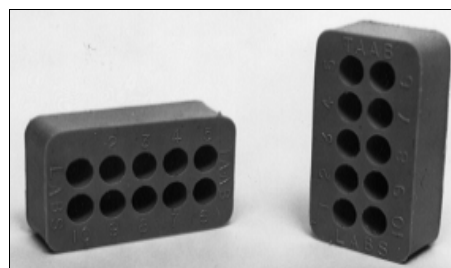

Embedding Moulds and Stubs

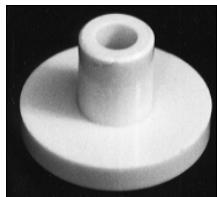

E081

E092

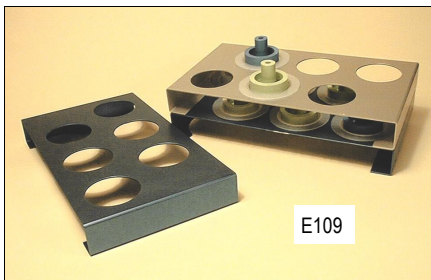

E109

An embedding system producing ready mounted blocks in a choice of **four sizes** for direct mounting to microtomes. The rigid plastic stubs bond to all resins and can be clamped in the microtome on a choice of two diameters, 25mm or 10mm. These stubs are inexpensive, can be written on for reference and are intended to be used as a disposable item. The E092 range of stubs has a deeper 25mm diameter flange to provide more secure clamping in the microtome. The stubs are available in a range of colours for coding of specimens. The polyethylene moulds are individual items which nest in stackable aluminium trays embedding trays each holding up to 6 moulds, which can be any one of the four available mould types 16 x 8 x 5mm deep; 12 x 8 x 5mm deep; 19 x 13 x 5mm deep and 16 x 2 x 5mm deep.

The aluminium trays are durable and with reasonable care will last for years. The moulds may be re-used several times.

E079	Embedding mould 12mm x 8mm	per 100
E080	Embedding mould 16mm x 8mm	per 100
E105	Embedding mould 19mm x 13mm	per 100
E106	Embedding mould 16mm x 2mm	per 100
E109	Embedding tray	per 10
E081	Embedding stubs – shallow flange – white	per 100
E081/B	Embedding stubs – shallow flange – blue	per 100
E081/G	Embedding stubs – shallow flange – green	per 100
E081/R	Embedding stubs – shallow flange – random colours	per 100
E081/Y	Embedding stubs – shallow flange – yellow	per 100
E092	Embedding stubs – deep flange – white	per 100
E092/B	Embedding stubs – deep flange – blue	per 100
E092/G	Embedding stubs – deep flange – green	per 100
E092/R	Embedding stubs – deep flange – random colours	per 100
E092/Y	Embedding stubs – deep flange – yellow	per 100

Histological Embedding Moulds

With the routine use of resin embedding in the histological field, there is a demand for convenient moulds to accommodate larger sections. The **four** green silicone rubber moulds each accommodate four referenced blocks, the base in each case being 25 x 25mm. The area containing the material to be sectioned comes in **four** sizes, 10 x 10mm; 10 x 15mm; 10 x 20mm and 10 x 25mm.

E065	Histological mould 10 x 10mm	each
E066	Histological mould 10 x 15mm	each
E067	Histological mould 10 x 20mm	each
E068	Histological mould 10 x 25mm	each

Technovit Teflon Histoform Embedding Moulds

T393 Histoform S A Teflon mould giving easy removal of 10 plastic blocks using the Histobloc system. Backed by a heavy steel plate to act as a heat sink and ensure lower curing temperatures within the block. This is particularly pertinent to immunocytochemical work. *Mould cavities* 10mm wide x 16mm high x 6.5mm deep

T394 Histoform Q As Histoform S but with *mould cavities* 20mm wide x 16mm high x 10mm deep.

T405 Histoform N As above but with *mould cavities* 9mm W x 18mm H x 5mm D.

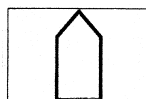
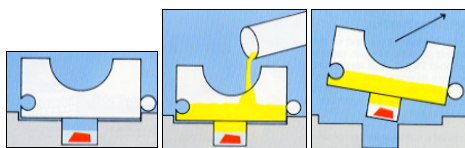

Histoform S



Histoform Q



Histobloc An easily fixed and permanent backing for Histoform specimens that can be clamped into all rotary microtomes without an adapter. Easy to write on and they link together for storage.

T395 Histobloc mounting blocks for S and Q pack of 100 **T395/N** Histobloc for Histoform N mould

Embedding Mould – 24 Cavity

This silicone rubber mould has **24** flat cavities each one lettered in relief, mould size 12mm x 4.5mm x 3mm deep. There is also a group of hemispherical depressions for embedding droplets of tissue or for housing specimens prior to embedding. Overall size of mould 80mm x 55mm.

E061 Embedding mould type 'A' each
E061/1 Embedding mould type 'A' per 10

A **special** green rubber mould identical to the above mould but *resistant* to Spurr's resin is also available.

E061/G Embedding mould type 'A' – Green each



Block Holder **S264** shown holding flat resin block
 See page 5.19 for more details.

Embedding Mould – Round

This green silicone rubber mould has **6** round cavities of 14mm diameter x 3mm deep. Overall size of mould 68mm x 46mm.

E070 Embedding mould type 'D' each



Embedding Mould – Large Round

A green silicone mould 92mm in diameter, with **10** compartments. Very useful for large or multiple specimen embedding in one segment.

E108 Embedding mould – large round each



NEW – The following silicone rubber moulds are now available in a transparent form, which make them ideal for specimen orientation if transmitted light is used.

Embedding Mould Large –28 Cavity

A green silicone rubber mould with **20** unmarked cavities 12mm x 6mm 3mm deep with trapezoidal shaped tip at one end, and a further **8** cavities of rectangular shape 3.5mm wide in a variety of lengths of 12mm; 24.5mm and 30mm. Overall size of mould 113mm x 70mm.

E069 Embedding mould type 'C' each
E069/C Embedding mould type 'C' – Clear each

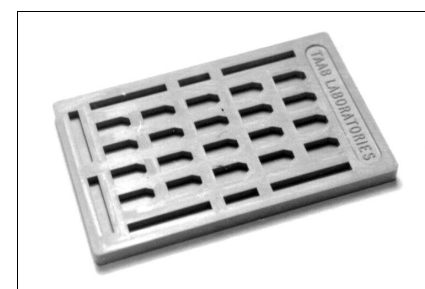

Embedding Mould – 21 Cavity

This green silicone rubber mould has **21** flat cavities, each one numbered in relief, mould size 13mm x 4.5mm x 3mm deep. This mould is similar to E061 (type 'A') but for larger specimens. Overall size of mould 69mm x 70mm.

E071 Embedding mould type 'B' each
E071/C Embedding mould type 'B' – Clear each

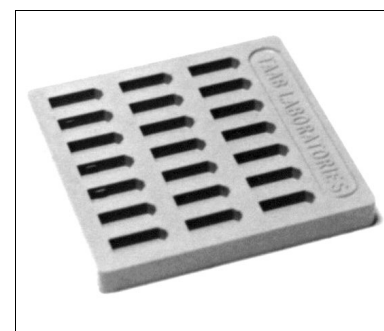

Double-End Flat Mould

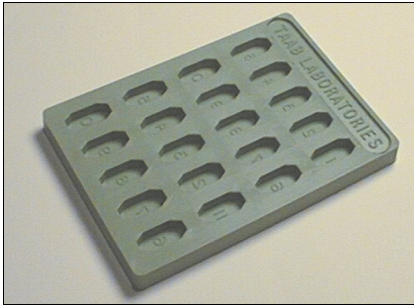

This green silicone rubber mould will produce pre-trimmed trapezoidal flat blocks shaped at both ends. Capacity 20 numbered cavities, the block size produced is 14mm x 6mm x 4mm deep. Overall size of mould is 93 x 62mm.

E094	Embedding mould type 'E'	each
E094/C	Embedding mould type 'E' – Clear	each

Flat Embedding Mould – Large

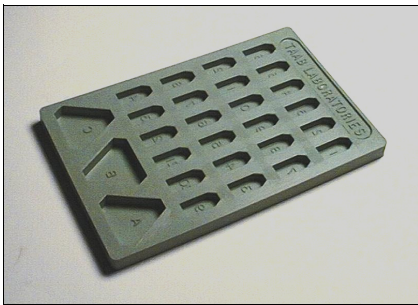

This green silicone rubber mould has 24 self numbered cavities and produces blocks with trapezoidal tip at one end for easy trimming. The produced block is 14mm x 6mm x 4mm deep and the mould also contains 3 special cavities for multiple embedding which can hold 3 samples in each cavity. Overall size of mould 118mm x 78mm.

E095	Embedding mould type 'F'	each
E095/C	Embedding mould type 'F' – Clear	each

Small Embedding Mould

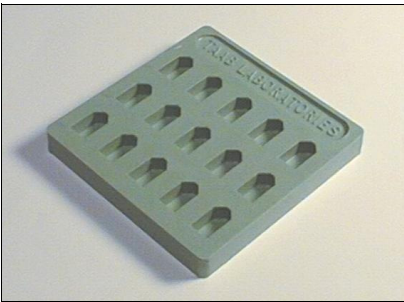

A green silicone rubber mould with 15 unmarked cavities. Specimen blocks measure 11mm x 6mm x 5mm deep, and produces a pre-trimmed trapezoidal shape at one end and a flat end at the other. Overall size of mould 68mm x 68mm.

E096	Embedding mould type 'G'	each
E096/C	Embedding mould type 'G' – Clear	each

Dual Section Embedding Mould

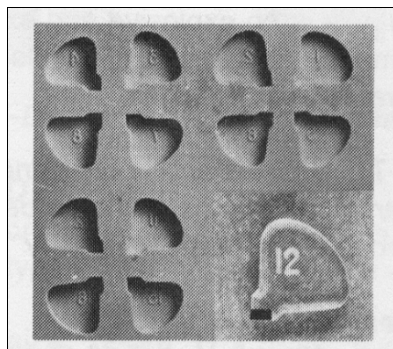

The Chien dual section silicon mould significantly increases the survey area without the necessity for lengthy re-embedding. The mould design allows both transverse and lateral sections to be obtained from the same block. The mould is reusable and produces 16 indexed, sharply defined pre-trimmed blocks that are adaptable to any microtome. Block dimensions 13mm long x 3mm thick.

E111	Dual section mould	each
-------------	--------------------	------

Polyethylene Cups



Designed as stoppers, the range of sizes offer an ideal alternative as an inexpensive disposable flat embedding mould.

C082	Polythene cup 35mm diam. x 22mm deep	pack 50
C083	Polythene cup 28mm diam. X 18mm deep	pack 50
C084	Polythene cup 22mm diam. X 16mm deep	pack 50
C085	Polythene cup 18mm diam. X 14mm deep	pack 50

FIB SEM Mould for Biological Specimens

A silicon rubber mould developed by Cancer Research UK London Laboratories (Dr Lucy Collinson, paper in publication) to minimise FIB erosion time for biological specimens.

This 6 cavity mould is reusable many times if handled with care.

E119 6 cavity FIB SEM mould

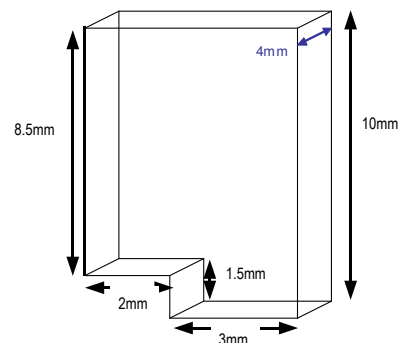

Disposable Weighing Dish/Boat

ALUMINIUM

An aluminium weighing dish that is useful for EM pre-embedding procedures, and is also ideal for static-less weighing. The base diameter is 53mm and the depth is 17mm.

W083 Disposable weighing dish pack 144



POLYSTYRENE

A high impact polystyrene weighing boat designed to be bent between the fingers to give a funnel shape to facilitate pouring. Available in either black or white with a choice of two sizes.

W082	Weighing boat 30ml - white	100
W082/B	Weighing boat 30ml - black	100
W104	Weighing boat 100ml - white	100
W104/B	Weighing boat 100ml - black	100



Millipore Filters

A series of graded filter pads composed of biologically inert mixtures of cellulose acetate and cellulose nitrate and a specially designed Luer fitting filter holder made from polypropylene with a silicone gasket. Available in a range of pore sizes making them suitable for fine filtering of solutions.

F093	Millipore holder – swinnex 25mm	each
F094	Millipore filters 0.45µm	pack 100
F095	Millipore filters 0.22µm	pack 100

For a comprehensive range of filtering equipment manufactured by Sartorius see Filtration Section.



Porous Capsules

Another innovation from TAAB. The capsule is produced in two parts, the base in polyethylene and the wall in porous sintered polyethylene. The capsule allows the easy transfer of specimens from one solution to another without handling or risk of loss. On removal from a solution the “wetted” type capsule drains completely.

Pore size of wall material is 100 microns.

The capsule can be supplied wetted for aqueous solutions or non-wetted for non-aqueous solutions. The wetted capsule needs to be re-wetted after about 10 uses to retain its maximum drainage characteristics.

There are two sizes of capsule one of ½” outside diameter and the other of 1” outside diameter, for applications requiring a closure, additional base plugs are available in both sizes.

C078	Porous capsule – 12.7mmdiam. X 15.7mm deep – wetted	10
C079	Porous capsule – 12.7mmdiam. X 15.7mm deep – non wetted	10
C080	Porous capsule – 25.4mm diam. x 25.4mm deep – wetted	10
C081	Porous capsule – 25.4mm diam. x 25.4mm deep – non-wetted	10
C078/1	Additional base plugs for 12.7mm capsules	10
C080/1	Additional base plugs for 25.4mm capsules	10
W077	Wetting agent	250ml



Spotting Tile – Porcelain – 12 Cavity

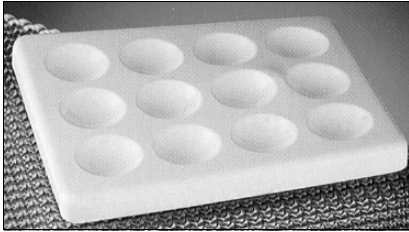

A white glazed porcelain tile, eliminates the problem associated with polypropylene tiles, that of twisting. There are 12 cavities having depression diameter of approximately 12mm and a capacity of 1ml. A high quality spotting tile for EM staining, replica washing, colour reactions etc.

Dimensions; 115mm x 90mm x 12mm thick.

T178 Spotting tile – porcelain – 12 cavity each

Spotting Tile – Polypropylene – 12 Cavity

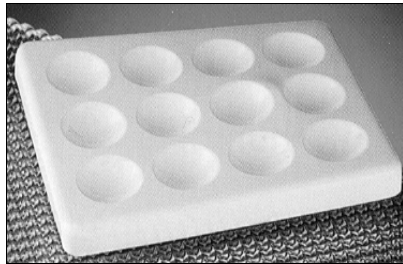

White easily cleaned tile, replacing porcelain. There are 12 cavities of approximately 1ml capacity. An economically priced, high quality, unbreakable spotting tile for EM staining, replica washing, colour reactions.

Dimension; 115mm x 95mm.

T140 Spotting tile – polypropylene – 12 cavity each

White Tile

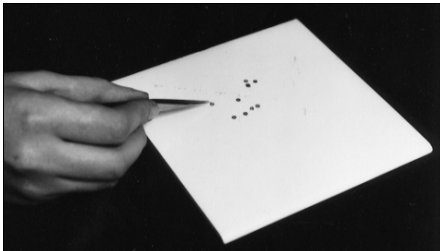

Provides a background of good visibility for handling specimens which are not normally easily seen, for trimming specimens to a size suitable for processing. Easily kept clean, white ceramic 150mm x 150mm.

T126 White tile – ceramic pack 2

Spotting Tile – PVC

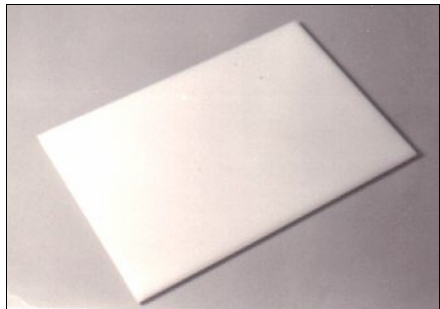

Plain flat, unbreakable white tile, an alternative to ceramic tiles. Dimensions: 100mm x 100mm x 4mm thick.

T141 Spotting tile PVC pack 2

Grid Plate

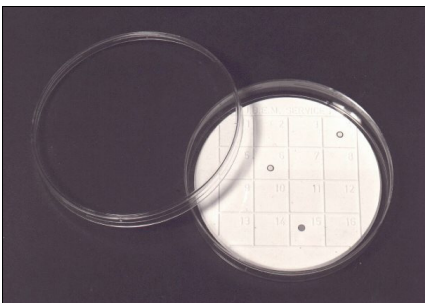

Silicone rubber indexed grid storage and transport plate housed in a polystyrene Petri dish. The ideal way of storing 'working' grids. The grids adhere lightly to the surface of the silicone mould, which eliminates the problem of grids jumping. The grids when required are easily picked up with tweezers. The grid disc are also available separately should you wish to supply your own plastic or glass Petri dishes. Available in sizes to fit 90mm or 50mm diameter Petri dishes.

G082 Grid plate (85mm) in Petri dish each
G082/1 Grid plate (85mm) in Petri dish pack 10
G082P Grid plate (85) – loose pack 10
G125 Grid plate (45mm) in Petri dish each
G125P Grid plate (45mm) – loose pack 10

Grid Transporting Box

For the storage or transport of a greater number of grids, TAAB has introduced the Grid Transporting Box, consisting of an indexed silicone rubber plate housed in a transparent viewing box with hinged lid. The silicone rubber plate is divided into 54 individual compartments of 10mm square, each compartment capable of holding 3 grids. The grids adhere well to the silicone rubber plate and the design of the plate eliminates any possibility of grids migrating from one cell to another. Dimension: 95mm x 70mm x 6mm deep. Each unit comes complete with a record card.

G117 Grid transporting box each
G117/1 Grid transporting box per 10



Mortar and Pestle

A moulded glass or porcelain mortar and pestle with foot and spout, the bowl diameter of 80mm is ideal for preparing powdered reagents prior to making into solutions.

M117 Mortar and pestle – glass each
M117/P Mortar and pestle – porcelain each

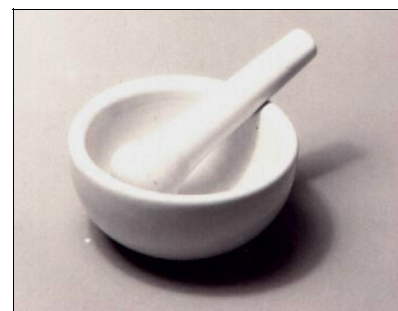

Stirring Sticks

Flat wooden 5" long disposable sticks, clean smooth finish ideal to mix and stir resins. All quantities are approx.

S125 Stirring sticks pack 500
S125/1 Stirring sticks pack 100

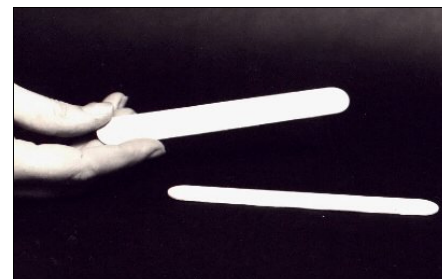

Stirring Rods

Plastic disposable stirring rods, 120mm long with 25mm long flattened end. Ideal for mixing of samples and solutions, for application of adhesives etc.

S333 Stirring rods pack 100

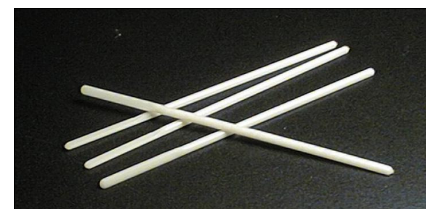

Dropper Bottles

Hexagonal amber glass bottle fitted with glass dropper, rubber teat and Bakelite cap.

B096 Dropper bottle – 10ml capacity per 10
B343 Dropper bottle - 20ml capacity per 10





Pasteur Pipette – Glass

Glass short form 150mm long, non-sterile pipettes.

P050	Pasteur pipette – glass	box 250
P052	Pipette bulb – 2ml capacity	pack 10

Pasteur Pipette – Polyethylene

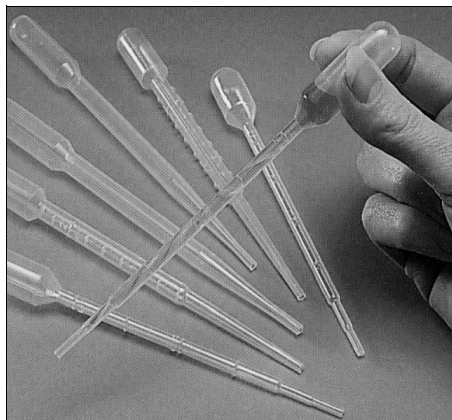

Disposable polyethylene pipettes with integral bulb that can be used to withdraw up to 3.5ml in one squeeze. The range provided by TAAB offer flexibility of use from handling viscous materials to dispensing very minute volumes of liquid. The use of plastic pipettes is very important to avoid any possibility of glass fragments contaminating embedded blocks that could damage a diamond knife when sectioning. Although the quantities shown below are box quantities it is possible that smaller pack sizes are available – please refer to price list.

Stirring Thermometer



A short form robust *total immersion* stirring thermometer, with a **reinforced bulb**. The thermometer is only 150mm long and will stand in an empty 50ml beaker without causing it to fall over. Calibrated in degrees Celsius on white background, with a range of –10 to 110°C.

T167	Thermometer – stirring	each
-------------	------------------------	------

Waterproof Stirring Thermometer

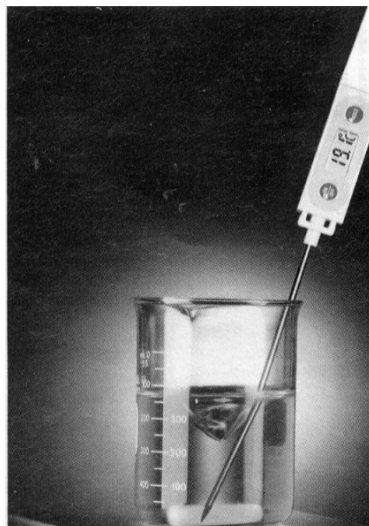

A cost-effective instrument designed for simplicity and accuracy.

An ideal instrument for liquid and semi-solid sampling. The probe protection sheath has a vent hole in the end so that the instrument can be used as a stirrer yet still display the sample temperature. The sheath can be connected to the head of the unit and used as a head extension.

- Rated waterproof to IP-65 standards.
- Membrane keypad features LCD and function buttons
- Selectable between °C and °F
- Polycarbonate body and vented sheath
- Data Hold function retains the displayed value allowing the removal of the probe from the sample.
- 125mm length x 4mm Diam. stainless steel probe with pointed tip
- The sensor is located in the bottom 10mm of the probe.
- Auto power off function activates after 10 minutes to preserve battery life.

Technical Specification;

Range °C/ °F	-50.0 to 150.0°C / -58 to 302°F	
Resolution	0.1 (-19.9 to 199.9), 1.0 (others)	
Accuracy °C/ °F	± 0.5°C / ±1.8°F	
Batteries/life	1 x 1.5v PL-13 button cell battery/500 hours approx.	
Dimensions (w x d x h), mm	230 x 20 x 18	weight; 36gm

T444	Waterproof stirring thermometer	each
-------------	---------------------------------	------

Petri Dish – Polystyrene

Clear plastic disposable dishes, 90mm diameter x 12mm deep. Produced under sterile aseptic condition, comply with BS611 part 2 and can be used in automatic plate pouring machines

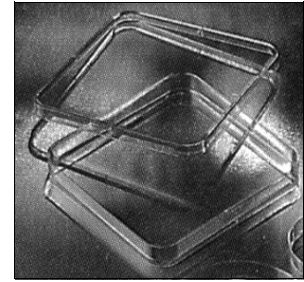
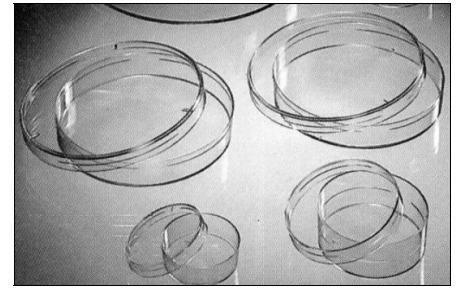
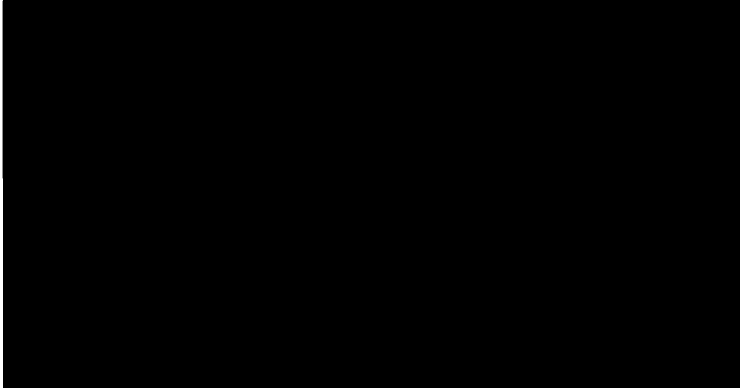

Petri Dish – Pyrex

A range of 20mm deep glass Petri dishes with 15mm deep covers, available singly.

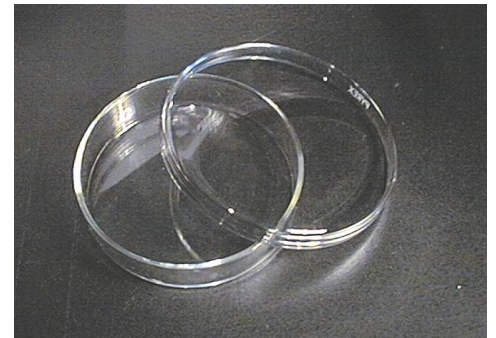
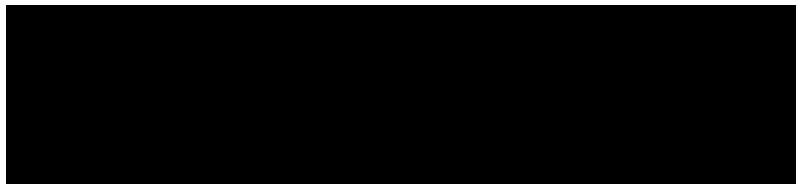

Filter Papers

Qualitative general purpose paper 0.18mm thickness.

P227	Filter paper No1, 90mm diameter	box 100
P228	Filter paper No1, 125mm diameter	box 100
P229	Filter paper No1, 55mm diameter	box 100
P295	Filter paper No1, 70mm diameter	box 100



Forceps - Membrane Filters

Membrane filters should only be handled with suitable forceps in order to avoid contamination, which can result from hand contact. These stainless steel forceps have smooth, flat tips. They are autoclavable and can be flamed.

T169	Forceps, stainless steel, membrane filters	each
------	--	------

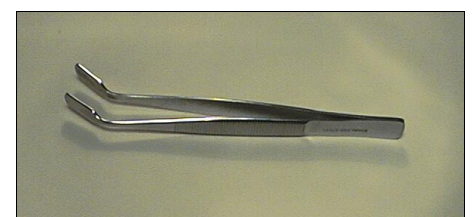

Petri Dish Stand

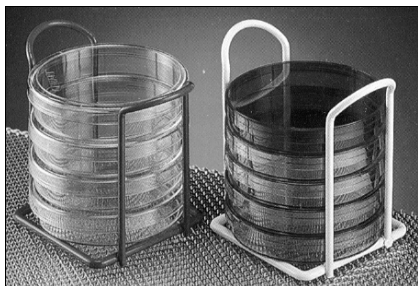

These useful stands will hold up to six 90mm Petri dishes. Manufactured from epoxy coated steel, dispenses 90mm Petri dishes from the base by gravity feed. Fully autoclavable and ideal for small batch incubation. The stands are available in seven different colours for easy batch coding.

P243	Petri dish stand – white	each
P244	Petri dish stand – red	each
P245	Petri dish stand – blue	each
P246	Petri dish stand – black	each
P249	Petri dish stand – grey	each

Plasticine



Soft moulding compound. In packs of 500g.

P234	Plasticine – blue	each
P235	Plasticine – white	each
P236	Plasticine – red	each
P237	Plasticine – grey	each

Melinex Film

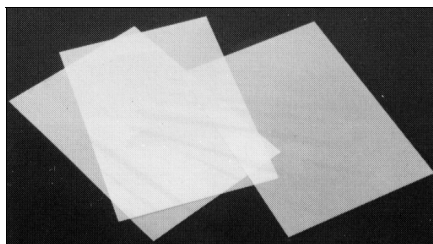

Ideal substrate for growing cell cultures which later can then be incorporated into blocks. Supplied as 10 x A5 sheets of Melinex, thickness 175µm.

M363	Melinex film - A5	pack 10
------	-------------------	---------

Weighing Paper

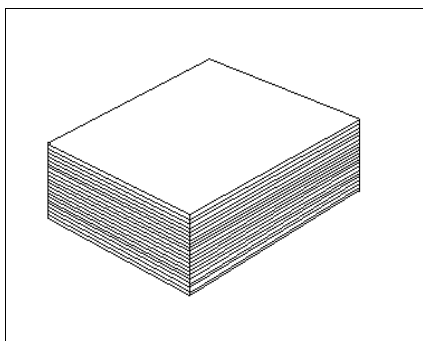

A special paper with a glossy surface which makes it very suitable for weighing powders. Dimensions are 100mm x 100mm

W105	Weighing paper 100mm x 100mm.	pack 1000
------	-------------------------------	-----------

Wash Bottles - Oval

Oval Polythene wash bottles for general cleaning applications. Slight pressure only is required to dispense liquid. The semi-flexible jet can be angled in any direction giving a better reach than that of the bottles with integral jet.

B213	Wash bottle oval 250ml	pack 5
B214	Wash bottle oval 500ml	pack 5

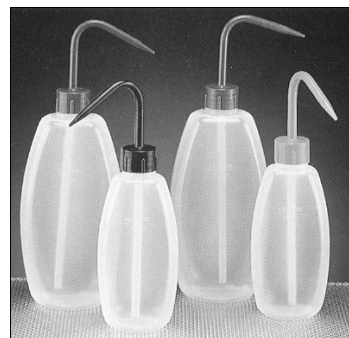

Wash Bottles

With integrally moulded tube and separate plain cap. Squared oval shape for stability and easy grip.

- B075** Wash bottle 250ml capacity each
B076 Wash bottle 500ml capacity each



Wash Bottles - Wide Neck - Printed

A vented washbottle for **safer** handling of volatile solvents. The round shape wide neck bottle has a two-way valve mechanism below the nozzle which is claimed stops the build-up of solvent vapour pressure - but closes to allow solvent to be dispensed in the normal way.

The venting stops the problem of solvent drips. Printed with a variety of solvent labels including a blank for customers use.

Water bottles are **without** valve mechanism.



White	"Deionised Water"	Green	"Methanol"
White	"Distilled Water"	Blue	"Isopropanol"
White	"Water"	Yellow	"IMS"
Red	"Acetone"	Orange	"Ethanol"
White	"Blank"		

- | | | | | | |
|-------------|-------------------------------|------|-------------|-------------------------------|------|
| B216 | Wash bottle 250ml Deion/Water | each | B226 | Wash bottle 250ml Isopropanol | each |
| B217 | Wash bottle 500ml Deion/Water | each | B227 | Wash bottle 500ml Isopropanol | each |
| B218 | Wash bottle 250ml Dist/Water | each | B228 | Wash bottle 250ml IMS | each |
| B219 | Wash bottle 500ml Dist/Water | each | B230 | Wash bottle 250ml Ethanol | each |
| B220 | Wash bottle 250ml Water | each | B231 | Wash bottle 500ml Ethanol | each |
| B221 | Wash bottle 500ml Water | each | B232 | Wash bottle 250ml Blank | each |
| B222 | Wash bottle 250ml Acetone | each | B233 | Wash bottle 500ml Blank | each |
| B223 | Wash bottle 500ml Acetone | each | | | |
| B224 | Water bottle 250ml Methanol | each | | | |
| B225 | Water bottle 500ml Methanol | each | | | |

Pocket Balance

A pocket balance in credit-card format. The draughtguard over the weighing area and display, protects the balance and also serves as a weighing pan.

Specification:

Capacity	100gms
Readability/accuracy	0.1gm/±0.1gm
Operating temperatures	+15° to +35°C
Weighing area	65 x 50mm
Batteries	2 x 3V CR2032 (included)
Dimensions	105 x 65 x 8mm
Weight	200gms



- B564** Credit card size pocket balance 100gms

Sartorius Analytical & Precision Balances

The "Talent" Series of Affordable Weighing Technology

Economically priced yet retaining the Sartorius high quality. **19 models** - one design. **Three analytical balances** with capacities of 60g, 120g, and 210g respectively and **16 precision balances** ranging from the top model with 3,100g capacity and 0.01g readability to the high-capacity model featuring 12Kg weighing capacity. **All** are dependable and accurate.

Ease of use is guaranteed. Just set them up, switch on, and start weighing.

Built-in Application Software. Various programs as standard to make to make routine work easy. Weighing in percent, net total formulation, weighn averaging/dynamic weighing, counting and mass unit conversion.

Selection Chart



Design 1

Specifications

Model	Readability [mg]	Weighing Capacity [g]	Repeatability [$\leq \pm$ mg]	Linearity [$\leq \pm$ mg]	Response Time average [\leq s]	Weighing Pan [mm]	Design
-------	------------------	-----------------------	--------------------------------	----------------------------	-----------------------------------	-------------------	--------

Analytical Balances

TE214S	0.1	210	0.0001	0.0002	3	Ø 90	1
TE124S	0.1	120	0.0001	0.0002	3	Ø 90	1
TE64	0.1	60	0.0001	0.0002	3	Ø 90	1



Design 2

Precision Balances

TE313S	0.001	310	0.001	0.002	2.5	Ø 100	2
TE313S-DS*	0.001	310	0.001	0.002	2.5	Ø 100	1
TE153S	0.001	150	0.0015	0.003	2.5	Ø 100	2
TE153S-DS*	0.001	150	0.0015	0.003	2.5	Ø 100	1
TE3102S	0.01	3,100	0.01	0.02	2.5	174 x 143	4
TE1502S	0.01	1,500	0.015	0.03	2.5	174 x 143	4
TE612	0.01	610	0.01	0.02	2	Ø 116	3
TE412	0.01	410	0.01	0.02	2	Ø 116	3
TE212	0.01	210	0.01	0.02	2	Ø 116	3
TE6101	0.1	6,100	0.1	0.2	2	174 x 143	4
TE4101	0.1	4,100	0.1	0.2	2	174 x 143	4
TE2101	0.1	2,100	0.1	0.2	1.5	174 x 143	4
TE601	0.1	610	0.1	0.2	1.5	174 x 143	4
TE12000	1	12,000	1	2	1.5	174 x 143	4
TE6100	1	6,100	1	2	1.5	174 x 143	4
TE4100	1	4,100	1	2	1.5	174 x 143	4



Design 3

* With analytical balance draft shield



Design 4