

SEM Specimen Stubs

Short Pin Type

Aluminium

1/2" Ø (12.7mm) with 3.2mm Ø x 8mm long pin, with groove for **Cambridge/LEO, Philips, Etec** etc instruments.

S081	1/2" Pin type stub (with groove)	pack of 100
S081/N	As above with alpha/numeric numbering	min pack of 100
S081/1	1/2" Pin type stub (with groove)	pack of 1000
S081/HP	1/2" Pin type stub (with groove) high purity Al for analysis apps	pack of 100
S182	1/2" Pin type stub (without groove)	pack of 100

S433	1/2" Pin type stub (with groove) Pin 3.2mm Ø x 6mm long for LEO	pack of 100
S434	1/2" Pin type stub (no groove) Pin 3.2mm Ø x 6mm long for LEO	pack of 100

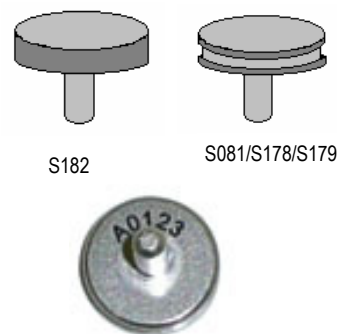

S081/N
Please state sequence when ordering

Brass

S178	1/2" Pin type stub (with groove)	pack of 10
-------------	----------------------------------	------------

Copper

S179	1/2" Pin type stub (with groove)	pack of 10
-------------	----------------------------------	------------

1" Ø (25.4mm) Aluminium Short Pin type stub with 3.2mm Ø pin for **Cambridge/LEO** and **Philips** instruments.

S087	1" Pin type stub	pack of 50
-------------	------------------	------------

32mm Ø Aluminium Short Pin type stub with 3.2mm Ø pin for **Camscan**

S181	32mm Ø pin type stub	pack of 50
-------------	----------------------	------------

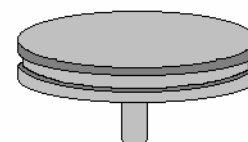

S087

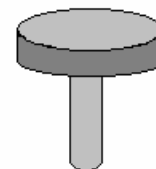

S180



S091

Long Pin Type

Aluminium 1/2" Ø (12.7mm) with 3.2mm Ø pin for **Amray**

S180	1/2" Amray pin stub	pack of 50
-------------	---------------------	------------

Re-entry Type

32mm (1 1/4") Ø re-entry (dish) type stub for **Cambridge/LEO**

S091	32mm (1 1/4") Ø Aluminium re-entry type stub	pack of 50
-------------	--	------------

Cylinder Type

Plain cylindrical aluminium stubs for **JEOL** instruments

S183	10mm Ø x 3.5mm high	pck of 50	S084	15mm Ø x 5mm high	pck of 50
S082	10mm Ø x 5mm high	pck of 50	S085	15mm Ø x 10mm high	pck of 50
S083	10mm Ø x 10mm high	pck of 50	S086	15mm Ø x 15mm high	pck of 50
S184	10mm Ø x 12.5mm high	pck of 50	S089	32mm Ø x 5mm high	pck of 50
S185	12.7mm Ø x 5mm high	pck of 50	S090	32mm Ø x 10mm high	pck of 50
S186	12.7mm Ø x 10mm high	pck of 50	S188	32mm Ø x 20mm high	pck of 50
S187	12.7mm Ø x 15mm high	pck of 50	S189	50mm Ø x 10mm high	pck of 50

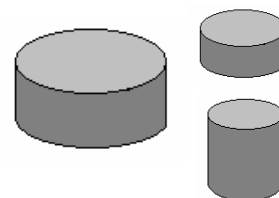

S261

Re-entry Type Stub Adapter

A simple, effective adapter to convert 12.7mm (1/2") pin stubs to allow 32mm (1.5") Ø re-entry dish type stubs to be used on 1/8" stage. The ball catch gives a trouble free, quick solution to a difficult problem.

S261	SEM stub adapter - re-entry stub
-------------	----------------------------------

10 SEM, TEM, STM Supplies

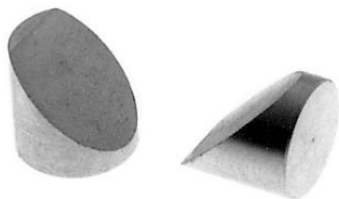

Chamfered Type

Aluminium stubs with a chamfered angle of 45° suitable for **JEOL** or **ISI** instruments where fitting stages are not available.

S127	Angled stub 10mm Ø	pack of 10
S190	Angled stub 12.7mm Ø	pack of 10
S126	Angled stub 15mm Ø	pack of 10

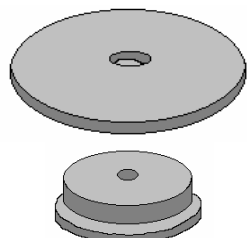

Threaded Type

Aluminium stubs threaded with M4 female thread in base for **Hitachi** instruments.

S128	Threaded stub 15mm Ø x 6mm high	pack of 50
S191	Threaded stub 25mm Ø x 6mm high	pack of 50
S192	Threaded stub 32mm Ø x 2mm high	pack of 50
S193	Threaded stub 32mm Ø x 10mm high	pack of 50

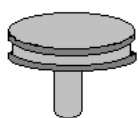

Types S100/101

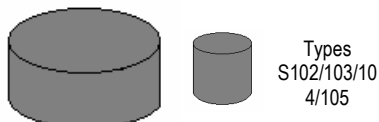

Types
S102/103/104/
105

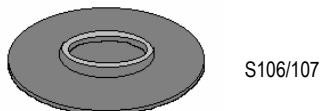

S106/107

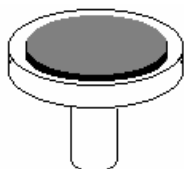

Carbon Stubs

Where the background radiation from the specimen stub is troublesome, a specimen stub manufactured from spectroscopic carbon may be used. Stubs for **Cambridge/LEO**, **JEOL** and **ISI** microscopes are available. They can have a *standard* finish or an *ultra smooth* finish for small particles or fibres.

S100	Carbon stub for Cambridge/LEO standard finish	each
S101	Carbon stub for Cambridge/LEO <i>ultra smooth</i> finish	each
S102	Carbon stub for JEOL (10mm Ø x 10mm H) standard	each
S103	Carbon stub for JEOL (10mm Ø x 10mm H) <i>ultra smooth</i>	each
S104	Carbon stub for ISI (15mm Ø x 10mm H) standard	each
S105	Carbon stub for ISI (15mm Ø x 10mm H) <i>ultra smooth</i>	each
S106	Carbon stub for Cambridge microanalysis stage std	each
S107	Carbon stub for Cambridge m/analysis stage <i>u/smooth</i>	each

Carbon Disc on Stub

This is an economical solution to the need for a light element surface for mounting specimens that are to be used for microanalysis. The carbon disc is 3mm thick and is glued to a standard ½" (12.7mm) stub.

Supplied in batches of 8 stubs in a stub storage box.

S111 Box of 8 carbon covered ½" (12.7mm) stubs



S402

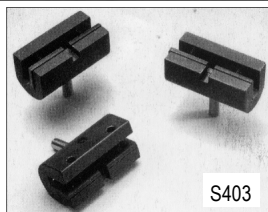

S403

Slotted Specimen Stubs

S402 A 12.5mm slotted aluminium pin stub with two Allen screws allowing the specimen to be securely clamped for examination. Allen key supplied.

S403 A gripping pin stub with slot and single screw to allow specimens to be mounted edge-on for examination (designed at the University of Leicester).

Stub Adapters

These adapters allow JEOL, ISI/ABT and Hitachi users to accommodate the standard pin stubs of the European and American manufacturers. The conversion cylinder contains a clip to hold the pin stub.

S367	Converter for JEOL, 10mm Ø cylinder
S367/1	Converter for JEOL, 12.5mm Ø cylinder
S367/2	Converter for ISI/ABT, 15mm Ø cylinder
S367/3	Converter for Hitachi, 15mm Ø cylinder with M4 internal thread

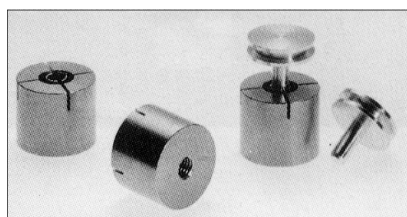

Specialised SEM Specimen Stubs

Stub for TEM Grids

In some applications (e.g. some SEM/EDX) results are improved if particulate samples are mounted on thin films deposited onto TEM grids. This pin-type aluminium stub allows four grids to be held securely for SEM work. There is a hole under each grid to reduce the backscatter component in electron collection and prevent extraneous X-ray collection.

- S400 SEM stub aluminium (pin-type) for TEM grids
- S401 SEM stub copper (pin-type) for TEM grids for cryo applications



Pin Stubs with Engraved Divisions

Aluminium SEM pin mounts with **engraved and numbered** divisions for multiple smaller samples to fit **FEI/Philips, ZEISS/LEO, Cambridge, Leica, Amray, Tescan** and **Camscan** SEMs. Pin is 3.2mm (1/8") and 9mm (3/8") long. Quality machined smooth surface.

- | | | |
|--------|--------------------------------------|------------|
| S536 | 12.7mm Ø pin mount with 4 divisions | each |
| S536/1 | 12.7mm Ø pin mount with 4 divisions | pack of 10 |
| S537 | 19mm Ø pin mount with 4 divisions | each |
| S537/1 | 19mm Ø pin mount with 4 divisions | pack of 10 |
| S538 | 25.4mm Ø pin mount with 12 divisions | each |
| S538/1 | 25.4mm Ø pin mount with 12 divisions | pack of 10 |
| S539 | 32mm Ø pin mount with 12 divisions | each |
| S539/1 | 32mm Ø pin mount with 12 divisions | pack of 10 |

Pin Stubs

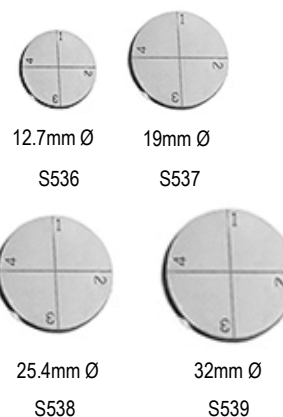

Special Size Aluminium Pin Stubs

- | | | |
|--------|---|-------------|
| S540 | SEM pin stub 6.4mm Ø diameter, standard pin | pack of 50 |
| S540/1 | SEM pin stub 6.4mm Ø diameter, standard pin | pack of 100 |
| S541 | SEM pin stub 12.7mm Ø with Flat on side | pack of 10 |
| S541/1 | SEM pin stub 12.7mm Ø with Flat on side | pack of 50 |
| S541/2 | SEM pin stub 12.7mm Ø with Flat on side | pack of 100 |
| S542 | SEM pin stub 38mm Ø with standard pin | each |
| S542/1 | SEM pin stub 38mm Ø with standard pin | pack of 10 |
| S543 | SEM pin stub 50mm Ø with standard pin | each |
| S543/1 | SEM pin stub 50mm Ø with standard pin | pack of 10 |
| S544 | SEM pin stub 63mm Ø with standard pin | each |
| S544/1 | SEM pin stub 63mm Ø with standard pin | pack of 10 |
| S545 | SEM pin stub 100mm Ø with standard pin | each |
| S545/1 | SEM pin stub 100mm Ø with standard pin | pack of 10 |



Angled Pin Stubs

- | | | |
|--------|--|------------|
| S546 | Pin stub swivel mount, 15mm Ø, 15mm pin | each |
| S547 | 45° angled high profile Al SEM pin stub 12.7mm Ø standard pin | pack of 5 |
| S548 | 45/90° angled high profile SEM pin stub 12.7mm Ø standard pin | each |
| S548/1 | 45/90° angled high profile SEM pin stub 12.7mm Ø standard pin | pack of 5 |
| S548/2 | 45/90° angled high profile SEM pin stub 12.7mm Ø standard pin | pack of 10 |
| S549 | 45° angled standard profile SEM pin stub 12.7mm Ø std pin | each |
| S549/1 | 45° angled standard profile SEM pin stub 12.7mm Ø std pin | pack of 5 |
| S549/2 | 45° angled standard profile SEM pin stub 12.7mm Ø std pin | pack of 10 |
| S550 | 45° angled standard profile SEM pin stub 25.4mm mm Ø std pin | each |
| S550/1 | 45° angled standard profile SEM pin stub 25.4mm mm Ø std pin | pack of 5 |
| S550/2 | 45° angled standard profile SEM pin stub 25.4mm mm Ø std pin | pack of 10 |
| S551 | 45/90° angled standard profile SEM pin stub 25.4mm Ø std pin | each |
| S551/1 | 45/90° angled standard profile SEM pin stub 25.4mm Ø std pin | pack of 5 |
| S551/2 | 45/90° angled standard profile SEM pin stub 25.4mm Ø std pin | pack of 10 |
| S660 | TV12 mini variable 0-90° angle tilt sample holder 11x12mm, std pin | each |
| S661 | TV25 variable 0-90° angle tilt holder for stubs up 38mm Ø, std pin | each |



Angled Pin Stubs cont..



S552	Double 45/90° angled SEM pin stub 25.4mm Ø standard Al pin	each
S552/1	Double 45/90° angled SEM pin stub 25.4mm Ø standard Al pin	pack of 5
S553	Double 90° SEM pin stub 25.4mm Ø standard pin Al pin	each
S553/1	Double 90° SEM pin stub 25.4mm Ø standard pin Al pin	pack of 5
S554	45/90° SEM pin stub 32mm Ø standard pin Al	each
S554/1	45/90° SEM pin stub 32mm Ø standard pin Al	pack of 5
S555	Double 90° SEM pin stub 32mm Ø standard pin Al pin	each
S555/1	Double 90° SEM pin stub 32mm Ø standard pin Al pin	pack of 5

SEM Pin Stubs with Extra Height



S556	Pin stub extender 12.7mm Ø x 22.7mm (10mm extra height)	each
S557	Pin stub 12.7mm Ø 4mm extra height std pin Al	pack of 5
S557/1	Pin stub 12.7mm Ø 4mm extra height std pin Al	pack of 10
S557/2	Pin stub 12.7mm Ø 4mm extra height std pin Al	pack of 50
S558	Pin stub 12.7mm Ø 6mm extra height std pin Al	pack of 5
S558/1	Pin stub 12.7mm Ø 6mm extra height std pin Al	pack of 10
S558/2	Pin stub 12.7mm Ø 6mm extra height std pin Al	pack of 50
S559	Pin stub 25.4mm Ø 4mm extra height std pin Al	pack of 5
S559/1	Pin stub 25.4mm Ø 4mm extra height std pin Al	pack of 10
S559/2	Pin stub 25.4mm Ø 4mm extra height std pin Al	pack of 50

SEM Pin Stubs Low Profile



S560	Low profile SEM pin stub 12.7mm Ø with 1mm height, Al	pack of 5
S560/1	Low profile SEM pin stub 12.7mm Ø with 1mm height, Al	pack of 10
S560/2	Low profile SEM pin stub 12.7mm Ø with 1mm height, Al	pack of 50
S561	Low profile pin stub 12.7mm Ø with 35° for Tescan, FIB x SEM	pack of 5
S561/1	Low profile pin stub 12.7mm Ø with 35° for Tescan, FIB x SEM	pack of 10
S561/2	Low profile pin stub 12.7mm Ø with 35° for Tescan, FIB x SEM	pack of 50
S562	Low profile pin stub 12.7mm Ø with 90° Al	pack of 5
S562/1	Low profile pin stub 12.7mm Ø with 90° Al	pack of 10
S562/2	Low profile pin stub 12.7mm Ø with 90° Al	pack of 50

Dish top Pin Stub

S563	SEM Dish pin stub, 12.7mm Ø x 7mm with 1.5mm dish depth Al	each
S563/1	SEM Dish pin stub, 12.7mm Ø x 7mm with 1.5mm dish depth Al	pack of 5
S563/2	SEM Dish pin stub, 12.7mm Ø x 7mm with 1.5mm dish depth Al	pack of 10

Specialised JEOL SEM Stubs

S564	JEOL 9.5mm Ø x 9.5mm angled SEM stub with 45° and 90° Al	pack of 10
S564/1	JEOL 9.5mm Ø x 9.5mm angled SEM stub with 45° and 90° Al	pack of 50
S565	JEOL 12.2mm Ø x 10mm angled SEM stub with 45° and 90° Al	pack of 10
S565/1	JEOL 12.2mm Ø x 10mm angled SEM stub with 45° and 90° Al	pack of 50
S566	JEOL 25mm Ø x 16mm angled SEM sample stub with 45° Al	pack of 5
S566/1	JEOL 25mm Ø x 16mm angled SEM sample stub with 45° Al	pack of 10
S567	JEOL 25mm Ø x 16mm SEM sample stub with 45° & 90° angles Al	each
S567/1	JEOL 25mm Ø x 16mm SEM sample stub with 45° & 90° angles Al	pack of 5
S568	JEOL 25mm Ø x 16mm SEM sample stub with double 90° Al	each
S568/1	JEOL 25mm Ø x 16mm SEM sample stub with double 90° Al	pack of 5
S569	JEOL Dish stub, 12.2mm Ø x 10mm with 1.5mm dish depth Al	pack of 10
S569/1	JEOL Dish stub, 12.2mm Ø x 10mm with 1.5mm dish depth Al	pack of 50
S646	Swivel mount sample holder with 1 clip on 15mm Ø plate on 12.2mm Ø JEOL stub	each

Specialised Hitachi SEM Stubs

S570	Hitachi 15mm Ø x 10mm M4 angled SEM sample stub 45° Al	each
S570/1	Hitachi 15mm Ø x 10mm M4 angled SEM sample stub 45° Al	pack of 5
S571	Hitachi 25mm Ø x 16mm M4 angled SEM sample stub 45° Al	each
S571/1	Hitachi 25mm Ø x 16mm M4 angled SEM sample stub 45° Al	pack of 5
S572	Hitachi 15mm Ø x 11mm M4 angled SEM sample stub 45° & 90° Al	each
S572/1	Hitachi 15mm Ø x 11mm M4 angled SEM sample stub 45° & 90° Al	pack of 5
S573	Hitachi 25mm Ø x 16mm M4 angled SEM sample stub 45° & 90° Al	each
S573/1	Hitachi 25mm Ø x 16mm M4 angled SEM sample stub 45° & 90° Al	pack of 5
S574	Hitachi 25mm Ø x 16mm M4 angled SEM stub, double 90° Al	each
S574/1	Hitachi 25mm Ø x 16mm M4 angled SEM stub, double 90° Al	pack of 5
S575	Hitachi 32mm Ø x 12mm M4 angled SEM sample stub 45° & 90° Al	each
S575/1	Hitachi 32mm Ø x 12mm M4 angled SEM sample stub 45° & 90° Al	pack of 5
S576	Hitachi 15mm Ø x 10mm M4 dish SEM sample stub, Al	pack of 5
S576/1	Hitachi 15mm Ø x 10mm M4 dish SEM sample stub, Al	pack of 10
S576/2	Hitachi 15mm Ø x 10mm M4 dish SEM sample stub, Al	pack of 50
S689	Hitachi stub swivel mount M4 15mm Ø x 30mm ± 90° Al/brass	each



Pin Stubs with SEM Sample Clips

The S-Clip sample holders comprise one or more spring loaded sample clips either on an SEM sample stub or holder. The spring loaded S-clips are specifically designed to hold thin specimens up to 2mm. Optional elevating (blocks) pillars are available to accommodate thicker samples. Washers can also be used to increase the clamping height.

The S-clips are made from conductive spring grade copper alloy mounted with a small M2 screw which allows the clip to rotate. Samples are clamped securely without the need for adhesives or conductive pastes. Sample changing is quick, easy and clean; contamination issues due to adhesives or glues are eliminated. They are ideal to hold Si chips and other thin samples. The S-Clip sample holders are available to hold samples horizontal (flat), at 45° or at 90°. The 45° and 90° are useful for holding cross sections of thin samples and wafer pieces. S-Clip sample holders are a cost effective alternative for the 1"-3" wafer holders. They can hold the smaller 1" (25.4mm), 2" (51mm) and 3" (76mm) wafers if it is allowed to hold the wafer down with clips:

38mm stub diameter is suitable for 1" (25.4mm) wafers; 63mm stub diameter is suitable for 2" (51mm) wafers and 100mm stub diameter is suitable for 3" (76mm) wafers.

The S-Clips are also separately available to enable customers to make their own custom made sample clip holders. Dimensions are 12.8mm long, tip is 1.6mm wide, height is 1.5mm with a 2.2mm Ø hole for mounting with an M2 screw. Made from 0.25mm thin spring grade copper alloy. Included with the S-clips are the M2 (x3) mounting screws.

S587	19mm Ø standard pin stub with 1 x S-Clip for FEI/Philips, LEO etc	
S588	19mm Ø short (6mm) pin stub with 1 x S-Clip for Zeiss	
S577/1	25mm Ø x 9mm pin stub with 1 clip for FEI/Philips, ZEISS/LEO, Cambridge,	each
S577/2	25mm Ø x 9mm pin stub with 2 clips for FEI/Philips, ZEISS/LEO, Cambridge,	each
S577/3	25mm Ø x 9mm pin stub with 3 clips for FEI/Philips, ZEISS/LEO, Cambridge,	each

Shorter version

S578/1	25mm Ø x 6mm pin stub with 1 clip for ZEISS/LEO, SEM, FIBs	each
S578/2	25mm Ø x 6mm pin stub with 2 clips for ZEISS/LEO, SEM, FIBs	each
S578/3	25mm Ø x 6mm pin stub with 3 clips for ZEISS/LEO, SEM, FIBs	each

S579/1	32mm Ø x 9mm pin stub with 1 clip for FEI/Philips, ZEISS/LEO, Cambridge,	each
S579/2	32mm Ø x 9mm pin stub with 2 clips for FEI/Philips, ZEISS/LEO, Cambridge,	each
S579/3	32mm Ø x 9mm pin stub with 3 clips for FEI/Philips, ZEISS/LEO, Cambridge,	each

S580/1	38mm Ø x 9mm pin stub with 1 clip for FEI/Philips, ZEISS/LEO, Cambridge,	each
S580/2	38mm Ø x 9mm pin stub with 2 clips for FEI/Philips, ZEISS/LEO, Cambridge,	each
S580/3	38mm Ø x 9mm pin stub with 3 clip for FEI/Philips, ZEISS/LEO, Cambridge,	each



Pin Stubs with Sample Clips cont...

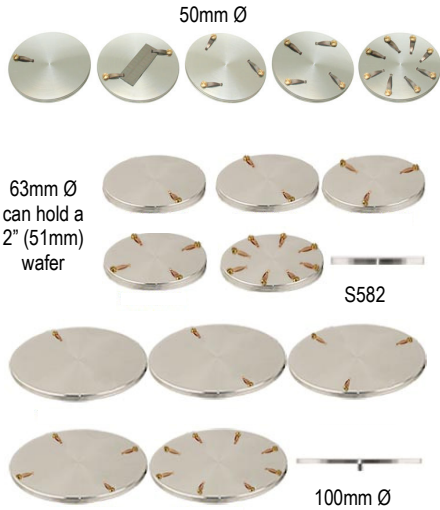

- S581/1** 50mm Ø x std pin stub with 1 clip for [FEI/Philips](#), [ZEISS/LEO](#), [Cambridge](#) each
- S581/2** 50mm Ø x std pin stub with 2 clips for [FEI/Philips](#), [ZEISS/LEO](#), [Cambridge](#) each
- S581/3** 50mm Ø x std pin stub with 3 clips for [FEI/Philips](#), [ZEISS/LEO](#), [Cambridge](#) each
- S581/4** 50mm Ø x std pin stub with 4 clips for [FEI/Philips](#), [ZEISS/LEO](#), [Cambridge](#) each
- S581/8** 50mm Ø x std pin stub with 8 clips for [FEI/Philips](#), [ZEISS/LEO](#), [Cambridge](#) each

- S582/1** 63mm Ø x std pin stub with 1 clip for [FEI/Philips](#), [ZEISS/LEO](#), [Cambridge](#) each
- S582/2** 63mm Ø x std pin stub with 2 clips for [FEI/Philips](#), [ZEISS/LEO](#), [Cambridge](#) each
- S582/3** 63mm Ø x std pin stub with 3 clips for [FEI/Philips](#), [ZEISS/LEO](#), [Cambridge](#) each
- S582/4** 63mm Ø x std pin stub with 4 clips for [FEI/Philips](#), [ZEISS/LEO](#), [Cambridge](#) each
- S582/8** 63mm Ø x std pin stub with 8 clips for [FEI/Philips](#), [ZEISS/LEO](#), [Cambridge](#) each

- S583/1** 100mm Ø x std pin stub with 1 clip for [FEI/Philips](#), [ZEISS/LEO](#), [Cambridge](#) each
- S583/2** 100mm Ø x std pin stub with 2 clips for [FEI/Philips](#), [ZEISS/LEO](#), [Cambridge](#) each
- S583/3** 100mm Ø x std pin stub with 3 clips for [FEI/Philips](#), [ZEISS/LEO](#), [Cambridge](#) each
- S583/4** 100mm Ø x std pin stub with 4 clips for [FEI/Philips](#), [ZEISS/LEO](#), [Cambridge](#) each
- S583/8** 100mm Ø x std pin stub with 8 clips for [FEI/Philips](#), [ZEISS/LEO](#), [Cambridge](#) each

S-Clips 45° & 90° on 25.4mm Ø & 12.7mm Ø Pin Stubs



- S589** S-Clip sample holder with 1 clip 45° on [25.4mm Ø](#) pin stub each
- S590** S-Clip sample holder swivel mount with 1 S-Clip on [25.4mm Ø](#) pin stub each
- S591** S-Clip sample holder with 2x S-Clips 45°/90° on [25.4mm Ø](#) pin stub each
- S592** S-Clip sample holder with 2x S-Clips double 90° on [25.4mm Ø](#) pin stub each
- S593** S-Clip sample holder with 1x S-Clip at 90° on [12.7mm Ø](#) pin stub each
- S594** S-Clip sample holder with 4x S-Clips at 90° on [12.7mm Ø](#) pin stub each
- S595** S-Clip sample holder with 4x S-Clips at 45° & 90° on pin stub each
- S596** S-Clip sample holder with 10x S-Clips at 90° on 10 x 50mm pin stub each

S-Clips on M4 Hitachi Stubs

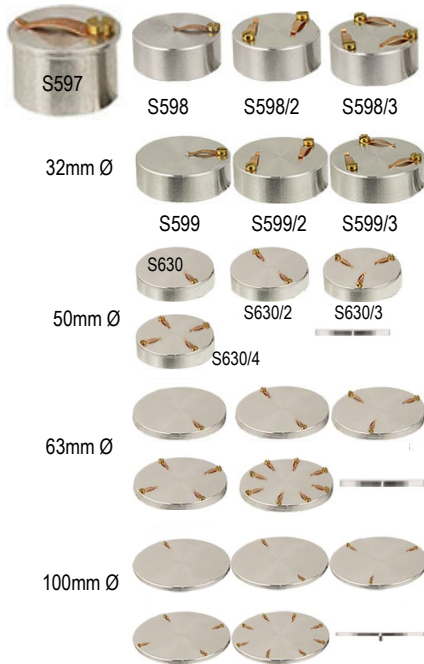

- S597** S-Clip sample holder with 1x S-Clip on 15mm Ø x 10mm stub, M4 each
- S598** S-Clip sample holder with 1x S-Clip on 25mm Ø x 10mm stub, M4 each
- S598/2** S-Clip sample holder with 2x S-Clip on 25mm Ø x 10mm stub, M4 each
- S598/3** S-Clip sample holder with 3x S-Clip on 25mm Ø x 10mm stub, M4 each

- S599** S-Clip sample holder with 1x S-Clip on 32mm Ø x 10mm stub, M4 each
- S599/2** S-Clip sample holder with 2x S-Clip on 32mm Ø x 10mm stub, M4 each
- S599/3** S-Clip sample holder with 3x S-Clip on 32mm Ø x 10mm stub, M4 each

- S630** S-Clip sample holder with 1x S-Clip on 50mm Ø x 6mm stub, M4 each
- S630/2** S-Clip sample holder with 2x S-Clip on 50mm Ø x 6mm stub, M4 each
- S630/3** S-Clip sample holder with 3x S-Clip on 50mm Ø x 6mm stub, M4 each
- S630/4** S-Clip sample holder with 4x S-Clip on 50mm Ø x 6mm stub, M4 each

- S631** S-Clip sample holder with 1x S-Clip on 63mm Ø x 6mm stub, M4 each
- S631/2** S-Clip sample holder with 2x S-Clip on 63mm Ø x 6mm stub, M4 each
- S631/3** S-Clip sample holder with 3x S-Clip on 63mm Ø x 6mm stub, M4 each
- S631/4** S-Clip sample holder with 4x S-Clip on 63mm Ø x 6mm stub, M4 each
- S631/8** S-Clip sample holder with 8x S-Clip on 63mm Ø x 6mm stub, M4 each

- S632** S-Clip sample holder with 1x S-Clip on 100mm Ø x 6mm stub, M4 each
- S632/2** S-Clip sample holder with 2x S-Clip on 100mm Ø x 6mm stub, M4 each
- S632/3** S-Clip sample holder with 3x S-Clip on 100mm Ø x 6mm stub, M4 each
- S632/4** S-Clip sample holder with 4x S-Clip on 100mm Ø x 6mm stub, M4 each
- S632/8** S-Clip sample holder with 8x S-Clip on 100mm Ø x 6mm stub, M4 each

S-Clips on M4 Hitachi Stubs 45° & 90°

- S633** S-Clip sample holder 45° with 1x S-Clip on 25mm Ø stub M4 each
S634 S-Clip sample holder 45°/90° with 2x S-Clip on 25mm Ø stub M4 each
S634/A S-Clip sample holder double 90° with 2x S-Clip on 25mm stub M4 each
S635 S-Clip sample holder 90° with 4x S-Clip on 12.7x12.7mm Ø stub M4 each
S636 S-Clip sample holder with 4x S-Clips at 45° & 4x S-Clips at 90°, M4 each
S637 S-Clip sample holder with 10x S-Clips at 90°, 10x50mm, stub M4 each



Spare S-Clip Screws & Elevating Blocks

- S638** 5 Copper alloy S-Clips with 5 each brass M2 x 3mm screws set
S639 6 each S-Clip elevating pillars, 4mm height, M2 x3mm male/female set



S-Clips on Flat JEOL Specimen Stubs

- S640** S-Clip sample holder with 1x S-Clip on 25mm Ø x 10mm JEOL SEM stub each
S640/2 S-Clip sample holder with 2x S-Clip on 25mm Ø x 10mm JEOL SEM stub each
S640/3 S-Clip sample holder with 3x S-Clip on 25mm Ø x 10mm JEOL SEM stub each



- S641** S-Clip sample holder with 1x S-Clip on 32mm Ø x 10mm JEOL SEM stub each
S641/2 S-Clip sample holder with 2x S-Clip on 32mm Ø x 10mm JEOL SEM stub each
S641/3 S-Clip sample holder with 3x S-Clip on 32mm Ø x 10mm JEOL SEM stub each



- S642** S-Clip sample holder with 1x S-Clip on 50mm Ø x 10mm JEOL SEM stub each
S642/2 S-Clip sample holder with 2x S-Clip on 50mm Ø x 10mm JEOL SEM stub each
S642/3 S-Clip sample holder with 3x S-Clip on 50mm Ø x 10mm JEOL SEM stub each
S642/4 S-Clip sample holder with 4x S-Clip on 50mm Ø x 10mm JEOL SEM stub each
S646 Swivel mount sample holder with 1 clip on 15mm Ø plate on 12.2mm Ø JEOL stub each



S-Clips on 45° & 90° JEOL Stubs

- S643** S-Clip sample holder with 1x S-Clip on 45° x 25mm Ø JEOL stub each
S644 S-Clip sample holder with 2x S-Clips at 45° & 90° on 25mm Ø JEOL stub each
S645 S-Clip sample holder with 2x S-Clips double 90° on 25mm Ø JEOL stub each



Stub Gripper Tweezers

The EM-Tec SEM stub tweezers securely grip SEM stubs and mounts to avoid touching them by hand to eliminate contamination issues. They are made from *anti-magnetic stainless steel* and are clean room compatible. They are excellent quality at an affordable price **and are available for:**

- All **grooved pin stubs** with 12.7, 19, 25.4 and 32mm head diameters (45° handle angle)
T600 anti-magnetic S/S tweezers for grooved pin stubs 12.7mm Ø 120mm long each
T601 anti-magnetic S/S tweezers for grooved pin stubs 19mm Ø 120mm long each
T602 anti-magnetic S/S tweezers for grooved pin stubs 25.4mm Ø 120mm long each
T603 anti-magnetic S/S tweezers for grooved pin stubs 32mm Ø 115mm long each
All **JEOL cylinder stubs** with 9.5, 12.2, 25.4 and 32mm head diameters (30° handle angle)
T604 anti-mag S/S grippers for 9.5mm Ø JEOL cylinder stubs 114mm long each
T605 anti-mag S/S grippers for 12.2mm Ø JEOL cylinder stubs 120mm long each
T606 anti-mag S/S grippers for 15mm Ø JEOL cylinder stubs 120mm long each
T607 anti-mag S/S grippers for 25mm Ø JEOL cylinder stubs 115mm long each
T608 anti-mag S/S grippers for 32mm Ø JEOL cylinder stubs 115mm long each
All **Hitachi cylinder stubs** with 15, 25 and 32mm head diameters (30° handle angle)
T609 anti-mag S/S grippers for 15mm Ø Hitachi & ISI cylinder stubs 120mm long each
T610 anti-mag S/S grippers for 25mm Ø Hitachi & ISI cylinder stubs 120mm long each
T611 anti-mag S/S grippers for 32mm Ø Hitachi & ISI cylinder stubs 120mm long each



SEM Sample Stub Adapters

Em-Tec SEM stub adapters enable the use of all common types of SEM stubs or mounts in your SEM. The advantages are:

- sample mounting independent of SEM platform
- time saved with no need to re-mount samples
- use of calibration and resolution standards mounted on different stubs
- no need to risk sample integrity
- enables collaborative investigation of samples

There are basically 5 common types of SEM sample stubs:

- Standard pin stubs with standard 9.5mm long pin used on FEI, Philips, Tescan, Phenom, Aspex, RJ Lee, Cambridge Instruments, Leica, Cam-Scan, ETEC and Novascan SEMs and SEM/FIB systems
- Zeiss pin stubs with short 6mm pin for Zeiss and LEO SEMs, CrossBeams and SEM/FIB systems
- Plain cylinder stubs for JEOL SEMs and SEM/FIB systems
- Hitachi cylinder stubs with M4 threaded base for Hitachi SEMs and FIBs
- Plain cylinder stubs for ISI, ABT, Topcon SEMs

For each of the above type mentioned SEM stubs there are EM-Tec SEM stub adapters available. The stub adapters are essentially made with the base of one type of an SEM stub and a top compatible with another type of SEM sample stub. All adaptors are all constructed from vacuum grade aluminium and made to original manufacturers specifications. The Hitachi stub extensions are made from self-lubricating brass with aluminium locking ring. Stub adapters are available as:

- Pin stub adapters for using other SEM stubs in pin type SEMs such as FEI, Philips, Tescan, Phenom, Aspex, Cambridge Instruments, Leica, etc. These can be used in Amray systems as well.
- Short pin stub adapters for using other SEM stubs in Zeiss and LEO SEMs
- JEOL stub adapters for using other pin stubs and Hitachi stubs in JEOL SEMs
- Hitachi M4 stub adapters for using pin stubs and JEOL stubs in Hitachi SEMs
- Other SEM stub adapters for less common SEMs such as ISI/ABT/Topcon and Agilent/Keysight
- Metal slide adapter to accommodate pin stubs on reflected light microscopes

For labs with multiple SEM platforms or for those who are regularly using different brands of SEMs, we offer the EM-Tec universal SEM stub adapter set. This universal SEM stub adapter set includes pin stub adapters, JEOL stub adapters (up to 25mm) and Hitachi stub adapters, all both ways. If you can't find the SEM stub or mount adapter you are looking for, please contact us. We might be able to offer a different solution or can manufacture custom SEM stub adapters.

Pin stub adapters for using different SEM stubs in pin type SEMs such as FEI, Philips, Tescan, Phenom, Aspex, Cambridge Instruments, Leica, etc.

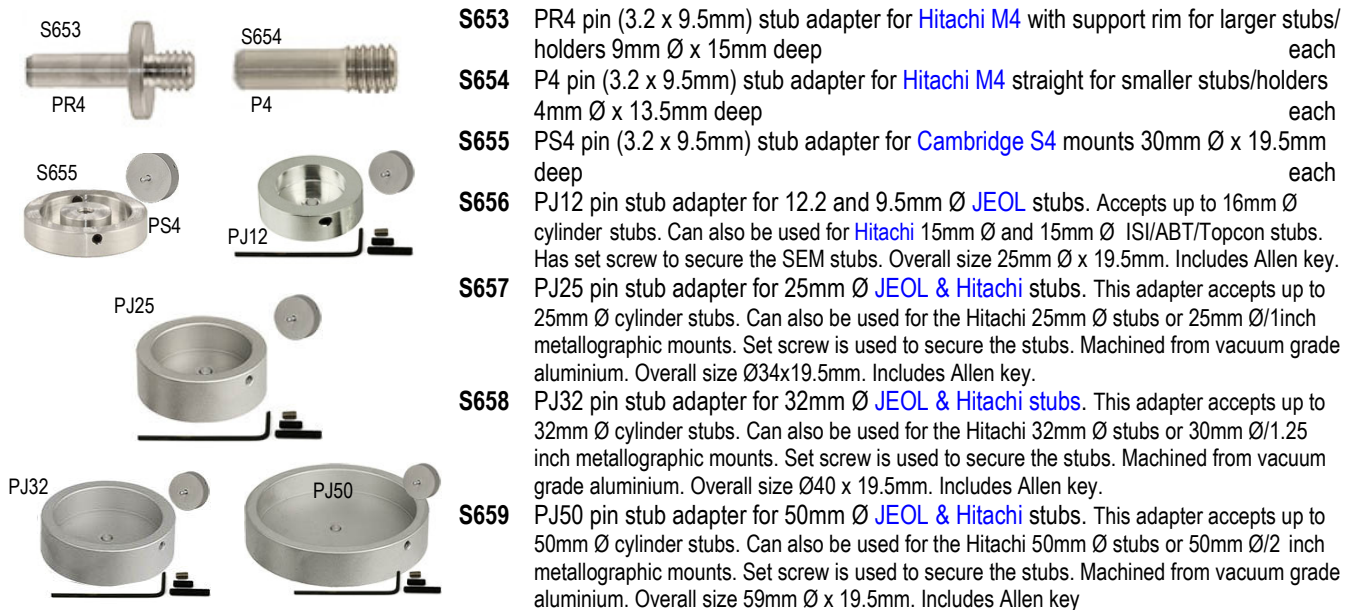

Zeiss short pin stub adapters for using different SEM stubs in Zeiss and LEO SEMs.
Pin stub adapters with the longer pin can be easily modified for use on Zeiss & LEO SEMs.

S647 ZR4 Zeiss pin stub adapter for **Hitachi M4** with support rim. Suitable for larger SEM stubs and larger SEM holders with M4 thread. Used on Zeiss and LEO SEMs. Pin is standard **3.2mm Ø and 6mm** long. The support rim has a 9mm Ø to give extra stability for larger SEM stubs and holders. Machined from vacuum grade aluminium. Overall size is 9mm Ø x1.5mm.



S648 Z4 Zeiss pin stub adapter to **Hitachi M4** for smaller SEM stubs and SEM holders with M4 thread. Used on Zeiss and LEO SEMs. Pin is standard 3.2mm diameter and 6mm long. Small design where the head of the adapter fits in the M4 thread. Machined from vacuum grade aluminium. Overall size is 4mm Ø x10mm.



S649 ZJ12 Zeiss pin stub adapter for 12.2mm and 9.5mm Ø **JEOL** stubs. This stub adapter accepts up to 16mm Ø cylinder stubs. Can also be used for the **Hitachi** and **ISI/ABT/Topcon** 15mm Ø stubs. Set screw is used to secure the stubs. Machined from vacuum grade aluminium. Overall size Ø25x16mm. Includes Allen key.



S650 ZJ25 Zeiss pin stub adapter for 25mm Ø **JEOL** stubs. This stub adapter accepts up to 25mm Ø cylinder stubs. Can also be used for the **Hitachi** 25mm/1" Ø stubs or 25mm Ø/1" metallographic mounts. Set screw is used to secure the stubs. Machined from vacuum grade aluminium. Overall size Ø34x16mm. Includes Allen key.



S651 ZJ32 Zeiss pin stub adapter for 32mm Ø **JEOL** stubs. This stub adapter accepts up to 32mm Ø cylinder stubs. Can also be used for the **Hitachi** 32mm/1" Ø stubs or 30mm Ø/1.25" metallographic mounts. Set screw is used to secure the stubs. Machined from vacuum grade aluminium. Overall size Ø34x16mm. Includes Allen key.



S652 ZJ50 Zeiss pin stub adapter for 50mm Ø **JEOL** stubs. This stub adapter accepts up to 50mm Ø cylinder stubs. Can also be used for the 50 mm/2" Ø stubs or 30mm Ø/2" metallographic mounts. Set screw is used to secure the stubs. Machined from vacuum grade aluminium. Overall size Ø34x16mm. Includes Allen key

Other Pin Stub Adapters

These adapters allow JEOL, ISI/ABT and Hitachi users to accommodate the standard pin stubs of the European and American manufacturers. The conversion cylinder contains a clip to hold the pin stub.

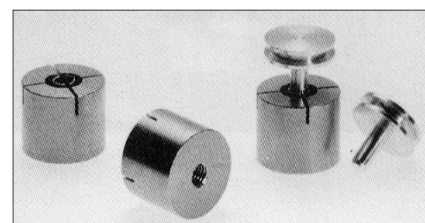

- S367** Converter for JEOL, 10mm Ø cylinder
- S367/1** Converter for JEOL, 12.5mm Ø cylinder
- S367/2** Converter for ISI/ABT, 15mm Ø cylinder
- S367/3** Converter for Hitachi, 15mm Ø cylinder with M4 internal thread

Gatan 3View sample pin stubs, tweezers and storage box

- G311** Gatan 3View system SEM pin stubs with standard 1.4mm Ø flat, 2mm Ø pin x12.5mm H, aluminium pack of 10
- G311/1** Gatan 3View system SEM pin stubs with standard 1.4mm Ø flat, 2mm Ø pin x12.5mm H, aluminium pack of 50
- G213** Gatan 3View system SEM pin stubs with large 2.4mm Ø flat, 2mm Ø pin x12.5mm H, aluminium pack of 10
- G312/1** Gatan 3View system SEM pin stubs with large 2.4mm Ø flat, 2mm Ø pin x12.5mm H, aluminium pack of 50
- T612** Gatan 3View stub handling tweezers, 118mm, anti-magnetic S/S each



B581 PS28 storage box for 28 Gatan 3View pin stubs each

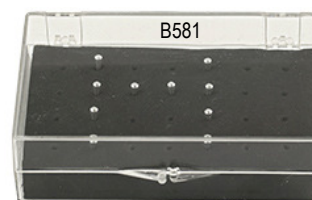

SEM Multiple Stub Holders

Our multiple pin stub holders are an efficient and cost-effective way to load multiple pin stubs with specimens in the SEM. Saves time, allows multi sample processing or quick comparison between samples. Intended for holding the standard 12.7mm (1/2") pin stubs, although the larger 25.4mm (1") pin stubs can be used on the holders for 6 pin stubs or more. All the positions on the holders for 6 pin stubs or more are **numbered** for easy identification and stubs are securely held with small M3 stainless steel set screws for the multi pin stub holders up to 12 pin stubs; an Allen key is included. On the 29 and 49 multi pin stub holders, the pin stubs are held with an integrated stainless steel spring. The 6 and 8 multi pin holders comprise engraved crossed lines to assist with directional navigation. They are all made from vacuum grade aluminium and have undergone a final cleaning step which results in a satin surface finish. Available with **standard pin** to fit FEI, Philips, Tescan, Phenom, Aspex, RJE, AmRay, Cambridge Instruments, Leica, CamScan, Aspex, ETEC and Novascan SEMs.

M4 threaded hole compatible with Hitachi SEMs, FESEMs and table top SEMs and **32mm JEOL SEM stub format** compatible with 32mm stub holders on JEOL SEMs. Additionally there are two **45° degrees pre-tilt multi-pin holders** available:

SEM Multi Pin Stub Holders on Standard Pin Base



Flat - Pin stubs 12.7 & 25.4mm Ø



- S662/4** P4 multi pin stub holder for 4 pin stubs, 31.5 mm Ø x 10.5mm, std pin each
S662/6 P6 multi pin stub holder for 6 pin stubs, 43mm Ø x 10.5mm, std pin each
S662/8 P8 multi pin stub holder for 8 pin stubs, 50mm Ø x 10.5mm, std pin each
S662/12 P12 multi pin stub holder for 12 pin stubs, 62mm Ø x 10.5mm, std pin each
S662/29 P29 multi pin stub holder for 29 pin stubs, 90mm Ø x 7mm, std pin each
S662/49 P49 multi pin stub holder for 49 pin stubs, 117mm Ø x 7mm, std pin each

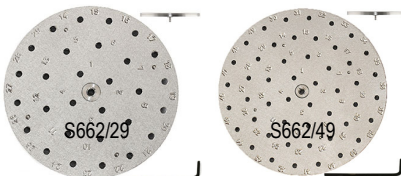

S663 P7 multi pin stub holder for 7 pin stubs 25.4mm Ø, 78mm Ø x 15mm, std pin each
 (No image)

Angled



- S664/3** P3/45 multi pin stub holder 45° for 3 pin stubs, 25mm Ø x 14mm, std pin each
S664/6 P6/45 multi pin stub holder 45° for 6 pin stubs, 35mm Ø x 14mm, std pin each

SEM Multiple Pin Stub Holders on M4 Hitachi Base



Flat - Pin stubs 12.7 & 25.4mm Ø



- S665/4** P4 multi pin stub holder for 4 pin stubs on M4 base 31mm Ø x 10.5mm each
S665/6 P6 multi pin stub holder for 6 pin stubs on M4 base 43mm Ø x 10.5mm each
S665/8 P8 multi pin stub holder for 8 pin stubs on M4 base 50mm Ø x 10.5mm each
S665/12 P12 multi pin stub holder for 12 pin stubs on M4 base 62mm Ø x 10.5mm each
S665/29 P29 multi pin stub holder for 29 pin stubs on M4 base 90mm Ø x 7mm each
S665/49 P49 multi pin stub holder for 49 pin stubs on M4 base 117mm Ø x 7mm each

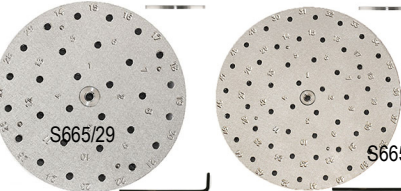

S666/7 P7 multi pin stub holder for 7 x 25.4mm Ø pin stubs, 78mm Ø 15mm M4 base each

Angled



- S667/3** P3/45° multi pin stub holder for 3 pin stubs, 25mm Ø x 14mm M4 base each
S667/6 P6/45° multi pin stub holder for 6 pin stubs, 35mm Ø x 14mm M4 base each

S668 Flat multi pin holder for 4 pin stubs 31.5mm Ø x 10.5mm on JEOL base each



Multiple Stub Holders for M4 Hitachi Stubs

Our multiple stub holders are an economical and simple way to load multiple Hitachi sample stubs with specimens in the SEM. Using multiple stub holders saves time, allows multi sample processing or allows quick comparison of samples. The horizontal multi stub holders are based on the 25mm Ø x 6mm x M4 and the 50mm Ø x 6mm x M4 Hitachi stubs to hold multiple stubs on M4 screws. The 45° multiple holders allow for a 45° pre-tilt which is beneficial for table top SEMs w/o a stage tilt or to quickly image under 45° w/o having to tilt the SEM stage. 45° tilted imaging tends to give a higher SE signal and reveals more of the topography of the specimen surface. The 45° multi stub holders are offered in two versions:

- Fixed M4 threaded screws to hold the Hitachi stubs
- Adjustable rotation M4 threaded screws for individual rotation of the Hitachi stubs to optimize viewing angle for the sample area

Flat

- S669** Multi stub holder for 3x15mm Ø M4 stubs, 25mm Øx6mm, 3.2mm Ø stage pin each
S670 Multi stub holder for 3x15mm Ø M4 stubs, 25mm Øx6mm with M4 thread each
S671 Multi stub holder for 3x25mm Ø M4 stubs, 50mm Øx6mm, 3.2mm Ø stage pin each
S672 Multi stub holder for 3x25mm Ø M4 stubs, 50mm Øx6mm with M4 thread each
S669/6 Multi stub holder for 6x15mm Ø M4 stubs, 50mm Øx6mm, 3.2mm Ø stage pin each
S670/6 Multi stub holder for 6x15mm Ø M4 stubs, 50mm Øx6mm with M4 thread each

Angled 45°

- S673** Multi holder 45° for 3x15mm Ø M4 stubs 25mm Ø x14mm, 3.2mm Ø stage pin each
S674 Multi stub holder for 3x15mm Ø M4 stubs, 25mm Øx14mm with M4 thread each
S673/6 Multi stub holder for 6x15mm Ø M4 stubs, 50mm Øx6mm, 3.2mm Ø stage pin each
S674/6 Multi stub holder for 6x15mm Ø M4 stubs, 50mm Øx6mm, with M4 thread each

45° Angled Stub Holders with Individual Rotation (IR)

Each M4 stub can be individually rotated to optimise the viewing angle for the sample area

- S675** Multi holder 45° IR for 3x15mm Ø M4 stubs, 25mm Øx14mm, std stage pin each
S676 Multi holder 45° IR for 3x15mm Ø M4 stubs, 25mm Øx14mm, M4 thread each
S675/6 Multi holder 45° IR for 6x15mm Ø M4 stubs, 35mm Øx14mm, std stage pin each
S676/6 Multi holder 45° IR for 6x15mm Ø M4 stubs, 35mm Øx14mm, M4 thread each

JEOL Multiple Cylinder Stub Holders

- S677** Multi stub holder for 4x 9.5mm Ø cylinder stubs 31.5mm Ø x 10mm deep each
S678 Multi stub holder for 3x 12.2mm Ø cylinder stubs 31.5mm Ø x 10mm deep each

JEOL multiple cylinder stub holders on standard (3.2mm Ø) pin base

- S679** Multi stub holder for 4x 9.5mm Ø cylinder stubs 31.5mm Ø x 10mm on std pin each
S680 Multi stub holder for 3x 12.2mm Ø cylinder stubs 31.5mm Ø x 10mm on std pin each
S681 Multi stub holder for 6x 12.2mm Ø cylinder stubs 50mm Ø x 10mm on std pin each

JEOL multiple cylinder stub holders on Hitachi M4 base

- S682** Multi stub holder for 4x 9.5mm Ø cylinder stubs 31.5mm Ø x 10mm M4 each
S683 Multi stub holder for 3x 12.2mm Ø cylinder stubs 31.5mm Ø x 10mm M4 each
S684 Multi stub holder for 6x 12.2mm Ø cylinder stubs 50mm Ø x 10mm M4 each



Gold Series SEM Sample Holders and Pin Stub Adapters

Our gold series SEM sample holders comprise a selection of compact holders, all made from brass and plated with 1µm of pure gold. Brass is chosen for greater strength and is fully non-magnetic. The gold plating assists in keeping the sample holders clean during handling. The superior chemical resistance of the gold plating facilitates the use of cleaning solutions or plasma cleaning. Clean sample holder surfaces will also greatly reduce contamination transfer to the samples. Intended for use with table top SEMs, laboratory grade SEMs and FESEMs.



Rectangular type bulk sample holder with pin (or M4) and two side brackets for sample thickness up to 16mm. Made from brass, 1µm thick gold plated. Ideal for smaller samples and smaller SEMs. Provided with 4 set screws.

S690 Bulk sample holder for up 16mm, gold plated brass, [Pin mount](#) each

S691 Bulk sample holder for up 16mm, gold plated brass, [M4 mount](#) each



Mini pin stub tube/needle clamp. Capacity up to 2mm Ø, the needle is secured with a small set screw. This holder is ideal for probes, needles, wire and thin tubes. Holder size is 6mm Ø x4mm. Made from brass and plated with 1µm of pure gold.

S692 Needle/tube sample holder for up to 2 mm Ø, gold plated brass, pin each



A swivel vice which covers a full 180° angle and can also be rotated with the stub. This is the ultimate holder for imaging cross sections at any desired angle. The swivel head size without clamping screws is only 16 x16 x 14mm. The sample is clamped with the two knurled clamping screws; the swivel head can be locked in place with the tilt clamping screw. Made from brass and plated with 1µm of pure gold.

S693 Swivel head sample holder for up 10mm samples, gold plated brass, pin each



Round type bulk sample holder with three brackets for round and awkwardly shaped samples up to 20mm Ø. Made from brass, 1µm thick gold plated. Ideal for smaller samples and smaller SEMs. Provided with 6 set screws.

S694 Bulk sample holder for up to 20mm Ø, gilded brass, [Pin mount](#) each

S695 Bulk sample holder for up to 20mm Ø, gilded brass, [M4 mount](#) each



Lightweight, spider like holder for awkwardly shaped samples up to 25mm Ø. Samples are supported by the three threaded legs and clamped by the flanges on the clamping nuts. Made from brass and plated with 1µm of pure gold.

S696 Spider type bulk sample holder for up to 25mm Ø, gold plated brass, [pin](#) each



Lightweight, spider like holder for awkwardly shaped samples up to 45mm Ø. Samples are supported by the three threaded legs and clamped by the flanges on the clamping nuts. Made from brass and plated with 1µm of pure gold.

S697 Spider type bulk sample holder for up to 45mm Ø, gold plated brass, pin each



Compact Zeiss pin stub adapter with M4 threaded head to convert stubs and sample holders with an M4 threaded hole to a Zeiss pin stub. Pin is 3.2mm diameter and 6mm long. Made from brass and plated with 1µm of pure gold.

S698 Compact Zeiss pin stub adapter with M4 thread, Au plated brass, short Zeiss pin each



Compact standard pin stub adapter with M4 threaded head to convert stubs and samples holders with an M4 threaded hole to a *standard pin stub*. Pin is 3.2mm diameter and 9.5mm long. Made from brass and plated with 1µm of pure gold.

S699 Compact standard pin stub adapter with M4 thread, gold plated brass, pin each

Universal SEM Sample Holder and SEM Stub Adapter Kit

The universal SEM sample holder and SEM stub adapter kit has been created to hold a wide variety of SEM samples up to 42mm. The samples can be flat, round, block or awkwardly shaped. Also included is a useful selection of SEM stub adapters which enables the kit to be used on virtually any SEM. Fully compatible with FEI/Philips, JEOL, Hitachi, Tescan, Zeiss/LEO and other brands of SEMs.

Ideally suited for:

- multi-user environments
- labs with different brands of SEMs
- labs with a large and changing variety of samples
- service labs to cope with different sample stubs
- portability between SEM platforms

The selection of SEM sample holders all include an M4 threaded hole. Fully compatible with the SEM stub adapters provided in this universal sample holder kit and with Hitachi SEMs.

Included SEM stub adapters in the kit are:

- pin stub adapters for FEI/Philips, Zeiss/LEO, Tescan, Amray
- a 12.2mm JEOL stub adapter with M4 screw
- a 12.2mm JEOL stub adapter for pin stubs
- Multi pin holder doubles as pin stub adapter for Hitachi SEMs.

List of included items: Compact vice clamp 0.22mm, Mini vice clamp 0.6mm, Multi holder for 4 pin stubs, Universal spring loaded vice holder up to 42mm, Bulk sample holder up to 32mm Ø, 3x S clip on 25mm Ø M4 stub, 2x S clip on 45/90° 25mm Ø M4 stub, Short pin stub adaptor with rim to M4, Std pin stub adaptor with rim to M4, Long pin stub adaptor with rim to M4, JEOL 12.2mm Ø stub to pin, JEOL 12.2mm Ø stub to M4.

The complete kit is presented in a high quality wooden box with all the SEM sample holder and adapters neatly arranged in a hard plastic insert. This kit can also be used to convert SEM sample stubs up to 32mm diameter to fit other SEM brands.

S475 Universal SEM sample holder and stub adapter kit in wooden box, complete with insert.



Details overleaf



Vacu-Storr High Vacuum SEM Sample Storage Protect Sensitive Samples & Calibration Standards

Dimensions & Capacities of Vacu-Storr

Container	Vacu-Store Small	Vacu-Storr Medium	Vacu-Storr Large	Vacu-Storr X-large
Inside diameter	41mm	76mm	76mm	140mm
Outside diameter	54mm	85mm	90mm	153mm
Volume	40cc	320cc	680cc	3800cc
Top opening diameter	40mm	75mm	75mm	75mm
Inside useable height	30mm	71mm	150mm	305mm
Total height	95mm	140mm	190mm	350mm