

SEM Specimen Stubs

Short Pin Type

Aluminium

1/2" Ø (12.7mm) with 3.2mm Ø x 8mm long pin, with groove for Cambridge/LEO, Philips, Etec etc instruments.

S081	1/2" Pin type stub (with groove)	pack of 100
S081/N	As above with alpha/numeric numbering	min pack of 100
S081/T		
S081/1	1/2" Pin type stub (with groove)	pack of 1000
S081/HP	1/2" Pin type stub (with groove) high purity Al for analysis apps	pack of 100
S182	1/2" Pin type stub (without groove)	pack of 100
S433	1/2" Pin type stub (with groove) Pin 3.2mm Ø x 6mm long for LEO	pack of 100
S434	1/2" Pin type stub (no groove) Pin 3.2mm Ø x 6mm long for LEO	pack of 100

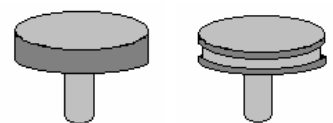

S182

S081/S178/S179



S081/N
Please state sequence when ordering



S081/T

Brass

S178	1/2" Pin type stub (with groove)	pack of 10
-------------	----------------------------------	------------

Copper

S179	1/2" Pin type stub (with groove)	pack of 10
-------------	----------------------------------	------------



S433

1" Ø (25.4mm) Aluminium Short Pin type stub with 3.2mm Ø pin for Cambridge/LEO and Philips instruments.

S087	1" Pin type stub	pack of 50
-------------	------------------	------------

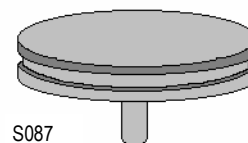

S087

32mm Ø Aluminium Short Pin type stub with 3.2mm Ø pin for Camscan

S181	32mm Ø pin type stub	pack of 50
-------------	----------------------	------------

Re-entry Type

32mm (1 1/4") Ø re-entry (dish) type stub for Cambridge/LEO

S091	32mm (1 1/4") Ø Aluminium re-entry type stub	pack of 50
-------------	--	------------



S091

Cylinder Type

Plain cylindrical aluminium stubs for JEOL instruments

S183 10mm Ø x 3.5mm high	pck of 50	S084 15mm Ø x	
S082 10mm Ø x 5mm high	pck of 50	S085 15mm Ø x 10mm high	pck of 50
S083 10mm Ø x 10mm high	pck of 50	S086 15mm Ø x 15mm high	pck of 50
S184 10mm Ø x 12.5mm high	pck of 50	S089 32mm Ø x 5mm high	pck of 50
S185 12.7mm Ø x 5mm high	pck of 50	S090 32mm Ø x 10mm high	pck of 50
S186 12.7mm Ø x 10mm high	pck of 50	S188 32mm Ø x 20mm high	pck of 50
S187 12.7mm Ø x 15mm high	pck of 50	S189 50mm Ø x 10mm high	pck of 50

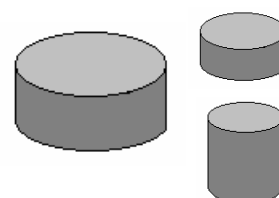

S261

Re-entry Type Stub Adapter

A simple, effective adapter to convert 12.7mm (1/2") pin stubs to allow 32mm (1.5") Ø re-entry dish type stubs to be used on 1/8" stage. The ball catch gives a trouble free, quick solution to a difficult problem.

S261	SEM stub adapter - re-entry stub
-------------	----------------------------------



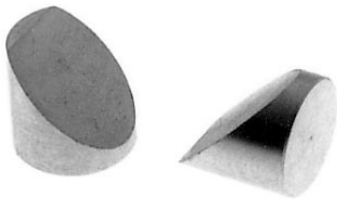

Chamfered Type

Aluminium stubs with a chamfered angle of 45° suitable for **JEOL** or **ISI** instruments where fitting stages are not available.

S127	Angled stub 10mm Ø	pack of 10
S190	Angled stub 12.7mm Ø	pack of 10
S126	Angled stub 15mm Ø	pack of 10

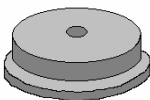
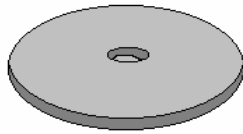

Threaded Type

Aluminium stubs threaded with M4 female thread in base for **Hitachi** instruments.

S128	Threaded stub 15mm Ø x 6mm high	pack of 50
S191	Threaded stub 25mm Ø x 6mm high	pack of 50
S192	Threaded stub 32mm Ø x 2mm high	pack of 50
S193	Threaded stub 32mm Ø x 10mm high	pack of 50

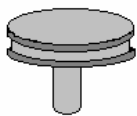

Types S100/101

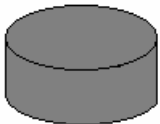
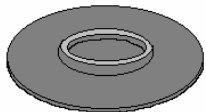
Types
S102/103/104/105

S106/107

Carbon Stubs

Where the background radiation from the specimen stub is troublesome, a specimen stub manufactured from spectroscopic carbon may be used. Stubs for **Cambridge/LEO**, **JEOL** and **ISI** microscopes are available. They can have a *standard* finish or an *ultra smooth* finish for small particles or fibres.

S100	Carbon stub for Cambridge/LEO standard finish	each
S101	Carbon stub for Cambridge/LEO <i>ultra smooth</i> finish	each
S102	Carbon stub for JEOL (10mm Ø x 10mm H) standard	each
S103	Carbon stub for JEOL (10mm Ø x 10mm H) <i>ultra smooth</i>	each
S104	Carbon stub for ISI (15mm Ø x 10mm H) standard	each
S105	Carbon stub for ISI (15mm Ø x 10mm H) <i>ultra smooth</i>	each
S106	Carbon stub for Cambridge microanalysis stage std	each
S107	Carbon stub for Cambridge m/analysis stage <i>u/smooth</i>	each

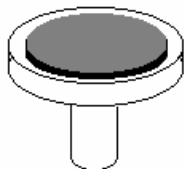

Carbon Disc on Stub

This is an economical solution to the need for a light element surface for mounting specimens that are to be used for microanalysis. The carbon disc is 3mm thick and is glued to a standard ½" (12.7mm) stub.

Supplied in batches of 8 stubs in a stub storage box.

S111 Box of 8 carbon covered ½" (12.7mm) stubs



S402

Slotted Specimen Stubs

S402 A 12.5mm slotted aluminium pin stub with two Allen screws allowing the specimen to be securely clamped for examination. Allen key supplied.

S403 A gripping pin stub with slot and single screw to allow specimens to be mounted edge-on for examination (designed at the University of Leicester).

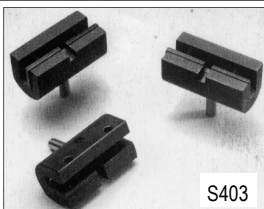

S403

Stub Adapters

These adapters allow JEOL, ISI/ABT and Hitachi users to accommodate the standard pin stubs of the European and American manufacturers. The conversion cylinder contains a clip to hold the pin stub.

S367	Converter for JEOL, 10mm Ø cylinder
S367/1	Converter for JEOL, 12.5mm Ø cylinder
S367/2	Converter for ISI/ABT, 15mm Ø cylinder
S367/3	Converter for Hitachi, 15mm Ø cylinder with M4 internal thread

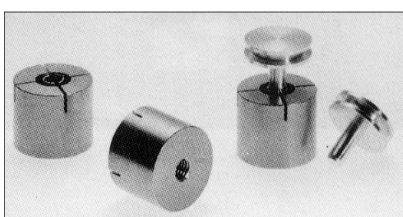

Specialised SEM Specimen Stubs

Stub for TEM Grids

In some applications (e.g. some SEM/EDX) results are improved if particulate samples are mounted on thin films deposited onto TEM grids. This pin-type aluminium stub allows four grids to be held securely for SEM work. There is a hole under each grid to reduce the backscatter component in electron collection and prevent extraneous X-ray collection.

- S400 SEM stub aluminium (pin-type) for TEM grids
- S401 SEM stub copper (pin-type) for TEM grids for cryo applications



Pin Stubs with Engraved Divisions

Aluminium SEM pin mounts with **engraved and numbered** divisions for multiple smaller samples to fit **FEI/Philips, ZEISS/LEO, Cambridge, Leica, Amray, Tescan** and **CamScan** SEMs. Pin is 3.2mm (1/8") and 9mm (3/8") long. Quality machined smooth surface.

- | | | |
|--------|--------------------------------------|------------|
| S536 | 12.7mm Ø pin mount with 4 divisions | each |
| S536/1 | 12.7mm Ø pin mount with 4 divisions | pack of 10 |
| S537 | 19mm Ø pin mount with 4 divisions | each |
| S537/1 | 19mm Ø pin mount with 4 divisions | pack of 10 |
| S538 | 25.4mm Ø pin mount with 12 divisions | each |
| S538/1 | 25.4mm Ø pin mount with 12 divisions | pack of 10 |
| S539 | 32mm Ø pin mount with 12 divisions | each |
| S539/1 | 32mm Ø pin mount with 12 divisions | pack of 10 |

Pin Stubs

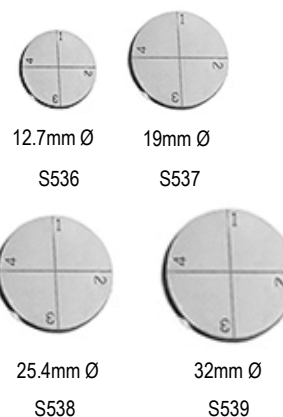

Special Size Aluminium Pin Stubs

- | | | |
|--------|---|-------------|
| S540 | SEM pin stub 6.4mm Ø diameter, standard pin | pack of 50 |
| S540/1 | SEM pin stub 6.4mm Ø diameter, standard pin | pack of 100 |
| S541 | SEM pin stub 12.7mm Ø with Flat on side | pack of 10 |
| S541/1 | SEM pin stub 12.7mm Ø with Flat on side | pack of 50 |
| S541/2 | SEM pin stub 12.7mm Ø with Flat on side | pack of 100 |
| S542 | SEM pin stub 38mm Ø with standard pin | each |
| S542/1 | SEM pin stub 38mm Ø with standard pin | pack of 5 |
| S543 | SEM pin stub 50mm Ø with standard pin | each |
| S543/1 | SEM pin stub 50mm Ø with standard pin | pack of 10 |
| S544 | SEM pin stub 63mm Ø with standard pin | each |
| S544/1 | SEM pin stub 63mm Ø with standard pin | pack of 10 |
| S545 | SEM pin stub 100mm Ø with standard pin | each |
| S545/1 | SEM pin stub 100mm Ø with standard pin | pack of 10 |



Angled Pin Stubs

- | | | |
|--------|--|------------|
| S546 | Pin stub swivel mount, 15mm Ø, 15mm pin | each |
| S547 | 45° angled high profile Al SEM pin stub 12.7mm Ø standard pin | pack of 5 |
| S548 | 45/90° angled high profile SEM pin stub 12.7mm Ø standard pin | each |
| S548/1 | 45/90° angled high profile SEM pin stub 12.7mm Ø standard pin | pack of 5 |
| S548/2 | 45/90° angled high profile SEM pin stub 12.7mm Ø standard pin | pack of 10 |
| S549 | 45° angled standard profile SEM pin stub 12.7mm Ø std pin | each |
| S549/1 | 45° angled standard profile SEM pin stub 12.7mm Ø std pin | pack of 5 |
| S549/2 | 45° angled standard profile SEM pin stub 12.7mm Ø std pin | pack of 10 |
| S550 | 45° angled standard profile SEM pin stub 25.4mm mm Ø std pin | each |
| S550/1 | 45° angled standard profile SEM pin stub 25.4mm mm Ø std pin | pack of 5 |
| S550/2 | 45° angled standard profile SEM pin stub 25.4mm mm Ø std pin | pack of 10 |
| S551 | 45/90° angled standard profile SEM pin stub 25.4mm Ø std pin | each |
| S551/1 | 45/90° angled standard profile SEM pin stub 25.4mm Ø std pin | pack of 5 |
| S551/2 | 45/90° angled standard profile SEM pin stub 25.4mm Ø std pin | pack of 10 |
| S660 | TV12 mini variable 0-90° angle tilt sample holder 11x12mm, std pin | each |
| S661 | TV25 variable 0-90° angle tilt holder for stubs up 38mm Ø, std pin | each |



Angled Pin Stubs cont..



S552	Double 45/90° angled SEM pin stub 25.4mm Ø standard Al pin	each
S552/1	Double 45/90° angled SEM pin stub 25.4mm Ø standard Al pin	pack of 5
S553	Double 90° SEM pin stub 25.4mm Ø standard pin Al pin	each
S553/1	Double 90° SEM pin stub 25.4mm Ø standard pin Al pin	pack of 5
S554	45/90° SEM pin stub 32mm Ø standard pin Al	each
S554/1	45/90° SEM pin stub 32mm Ø standard pin Al	pack of 5
S555	Double 90° SEM pin stub 32mm Ø standard pin Al pin	each
S555/1	Double 90° SEM pin stub 32mm Ø standard pin Al pin	pack of 5

SEM Pin Stubs with Extra Height



S556	Pin stub extender 12.7mm Ø x 22.7mm (10mm extra height)	each
S557	Pin stub 12.7mm Ø 4mm extra height std pin Al	pack of 5
S557/1	Pin stub 12.7mm Ø 4mm extra height std pin Al	pack of 10
S557/2	Pin stub 12.7mm Ø 4mm extra height std pin Al	pack of 50
S558	Pin stub 12.7mm Ø 6mm extra height std pin Al	pack of 5
S558/1	Pin stub 12.7mm Ø 6mm extra height std pin Al	pack of 10
S558/2	Pin stub 12.7mm Ø 6mm extra height std pin Al	pack of 50
S559	Pin stub 25.4mm Ø 4mm extra height std pin Al	pack of 5
S559/1	Pin stub 25.4mm Ø 4mm extra height std pin Al	pack of 10
S559/2	Pin stub 25.4mm Ø 4mm extra height std pin Al	pack of 50

SEM Pin Stubs Low Profile



S560	Low profile SEM pin stub 12.7mm Ø with 1mm height, Al	pack of 5
S560/1	Low profile SEM pin stub 12.7mm Ø with 1mm height, Al	pack of 10
S560/2	Low profile SEM pin stub 12.7mm Ø with 1mm height, Al	pack of 50
S561	Low profile pin stub 12.7mm Ø with 35° for Tescan, FIB x SEM	pack of 5
S561/1	Low profile pin stub 12.7mm Ø with 35° for Tescan, FIB x SEM	pack of 10
S561/2	Low profile pin stub 12.7mm Ø with 35° for Tescan, FIB x SEM	pack of 50
S562	Low profile pin stub 12.7mm Ø with 90° Al	pack of 5
S562/1	Low profile pin stub 12.7mm Ø with 90° Al	pack of 10
S562/2	Low profile pin stub 12.7mm Ø with 90° Al	pack of 50

Dish top Pin Stub



S563	SEM Dish pin stub, 12.7mm Ø x 7mm with 1.5mm dish depth Al	each
S563/1	SEM Dish pin stub, 12.7mm Ø x 7mm with 1.5mm dish depth Al	pack of 5
S563/2	SEM Dish pin stub, 12.7mm Ø x 7mm with 1.5mm dish depth Al	pack of 10

Specialised JEOL SEM Stubs

S564	JEOL 9.5mm Ø x 9.5mm angled SEM stub with 45° and 90° Al	pack of 10
S564/1	JEOL 9.5mm Ø x 9.5mm angled SEM stub with 45° and 90° Al	pack of 50
S565	JEOL 12.2mm Ø x 10mm angled SEM stub with 45° and 90° Al	pack of 10
S565/1	JEOL 12.2mm Ø x 10mm angled SEM stub with 45° and 90° Al	pack of 50
S566	JEOL 25mm Ø x 16mm angled SEM sample stub with 45° Al	pack of 5
S566/1	JEOL 25mm Ø x 16mm angled SEM sample stub with 45° Al	pack of 10
S567	JEOL 25mm Ø x 16mm SEM sample stub with 45° & 90° angles Al	each
S567/1	JEOL 25mm Ø x 16mm SEM sample stub with 45° & 90° angles Al	pack of 5
S568	JEOL 25mm Ø x 16mm SEM sample stub with double 90° Al	each
S568/1	JEOL 25mm Ø x 16mm SEM sample stub with double 90° Al	pack of 5
S569	JEOL Dish stub, 12.2mm Ø x 10mm with 1.5mm dish depth Al	pack of 10
S569/1	JEOL Dish stub, 12.2mm Ø x 10mm with 1.5mm dish depth Al	pack of 50
S646	Swivel mount sample holder with 1 clip on 15mm Ø plate on 12.2mm Ø JEOL stub	each
S737	Swivel mount holder ± 90° 12.2mm Ø x 21mm H Al	each

Specialised Hitachi SEM Stubs

S570	Hitachi 15mm Ø x 10mm M4 angled SEM sample stub 45° Al	each
S570/1	Hitachi 15mm Ø x 10mm M4 angled SEM sample stub 45° Al	pack of 5
S571	Hitachi 25mm Ø x 16mm M4 angled SEM sample stub 45° Al	each
S571/1	Hitachi 25mm Ø x 16mm M4 angled SEM sample stub 45° Al	pack of 5
S572	Hitachi 15mm Ø x 11mm M4 angled SEM sample stub 45° & 90° Al	each
S572/1	Hitachi 15mm Ø x 11mm M4 angled SEM sample stub 45° & 90° Al	pack of 5
S573	Hitachi 25mm Ø x 16mm M4 angled SEM sample stub 45° & 90° Al	each
S573/1	Hitachi 25mm Ø x 16mm M4 angled SEM sample stub 45° & 90° Al	pack of 5
S574	Hitachi 25mm Ø x 16mm M4 angled SEM stub, double 90° Al	each
S574/1	Hitachi 25mm Ø x 16mm M4 angled SEM stub, double 90° Al	pack of 5
S575	Hitachi 32mm Ø x 12mm M4 angled SEM sample stub 45° & 90° Al	each
S575/1	Hitachi 32mm Ø x 12mm M4 angled SEM sample stub 45° & 90° Al	pack of 5
S576	Hitachi 15mm Ø x 10mm M4 dish SEM sample stub, Al	pack of 5
S576/1	Hitachi 15mm Ø x 10mm M4 dish SEM sample stub, Al	pack of 10
S576/2	Hitachi 15mm Ø x 10mm M4 dish SEM sample stub, Al	pack of 50
S689	Hitachi stub swivel mount M4 15mm Ø x 21mm ± 90° Al/brass	each



Pin Stubs with SEM Sample Clips

The S-Clip sample holders comprise one or more spring loaded sample clips either on an SEM sample stub or holder. The spring loaded S-clips are specifically designed to hold thin specimens up to 2mm. Optional elevating (blocks) pillars are available to accommodate thicker samples. Washers can also be used to increase the clamping height.

The S-clips are made from conductive spring grade copper alloy mounted with a small M2 screw which allows the clip to rotate. Samples are clamped securely without the need for adhesives or conductive pastes. Sample changing is quick, easy and clean; contamination issues due to adhesives or glues are eliminated. They are ideal to hold Si chips and other thin samples. The S-Clip sample holders are available to hold samples horizontal (flat), at 45° or at 90°. The 45° and 90° are useful for holding cross sections of thin samples and wafer pieces. S-Clip sample holders are a cost effective alternative for the 1"-3" wafer holders. They can hold the smaller 1" (25.4mm), 2" (51mm) and 3" (76mm) wafers if it is allowed to hold the wafer down with clips:

38mm stub diameter is suitable for 1" (25.4mm) wafers; 63mm stub diameter is suitable for 2" (51mm) wafers and 100mm stub diameter is suitable for 3" (76mm) wafers.

The S-Clips are also separately available to enable customers to make their own custom made sample clip holders. Dimensions are 12.8mm long, tip is 1.6mm wide, height is 1.5mm with a 2.2mm Ø hole for mounting with an M2 screw. Made from 0.25mm thin spring grade copper alloy. Included with the S-clips are the M2 (x3) mounting screws.

S587	19mm Ø standard pin stub with 1 x S-Clip for FEI/Philips, LEO etc	
S588	19mm Ø short (6mm) pin stub with 1 x S-Clip for Zeiss	
S577/1	25mm Ø x 9mm pin stub with 1 clip for FEI/Philips, ZEISS/LEO, Cambridge,	each
S577/2	25mm Ø x 9mm pin stub with 2 clips for FEI/Philips, ZEISS/LEO, Cambridge,	each
S577/3	25mm Ø x 9mm pin stub with 3 clips for FEI/Philips, ZEISS/LEO, Cambridge,	each

Shorter version

S578/1	25mm Ø x 6mm pin stub with 1 clip for ZEISS/LEO, SEM, FIBs	each
S578/2	25mm Ø x 6mm pin stub with 2 clips for ZEISS/LEO, SEM, FIBs	each
S578/3	25mm Ø x 6mm pin stub with 3 clips for ZEISS/LEO, SEM, FIBs	each

S579/1	32mm Ø x 9mm pin stub with 1 clip for FEI/Philips, ZEISS/LEO, Cambridge,	each
S579/2	32mm Ø x 9mm pin stub with 2 clips for FEI/Philips, ZEISS/LEO, Cambridge,	each
S579/3	32mm Ø x 9mm pin stub with 3 clips for FEI/Philips, ZEISS/LEO, Cambridge,	each

S580/1	38mm Ø x 9mm pin stub with 1 clip for FEI/Philips, ZEISS/LEO, Cambridge,	each
S580/2	38mm Ø x 9mm pin stub with 2 clips for FEI/Philips, ZEISS/LEO, Cambridge,	each
S580/3	38mm Ø x 9mm pin stub with 3 clip for FEI/Philips, ZEISS/LEO, Cambridge,	each



Pin Stubs with Sample Clips cont...

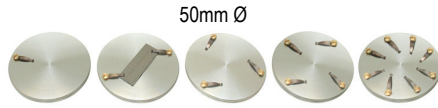

S581/1 50mm Ø x std pin stub with 1 clip for [FEI/Philips](#), [ZEISS/LEO](#), [Cambridge](#) each
S581/2 50mm Ø x std pin stub with 2 clips for [FEI/Philips](#), [ZEISS/LEO](#), [Cambridge](#) each
S581/3 50mm Ø x std pin stub with 3 clips for [FEI/Philips](#), [ZEISS/LEO](#), [Cambridge](#) each
S581/4 50mm Ø x std pin stub with 4 clips for [FEI/Philips](#), [ZEISS/LEO](#), [Cambridge](#) each
S581/8 50mm Ø x std pin stub with 8 clips for [FEI/Philips](#), [ZEISS/LEO](#), [Cambridge](#) each

S582/1 63mm Ø x std pin stub with 1 clip for [FEI/Philips](#), [ZEISS/LEO](#), [Cambridge](#) each
S582/2 63mm Ø x std pin stub with 2 clips for [FEI/Philips](#), [ZEISS/LEO](#), [Cambridge](#) each
S582/3 63mm Ø x std pin stub with 3 clips for [FEI/Philips](#), [ZEISS/LEO](#), [Cambridge](#) each
S582/4 63mm Ø x std pin stub with 4 clips for [FEI/Philips](#), [ZEISS/LEO](#), [Cambridge](#) each
S582/8 63mm Ø x std pin stub with 8 clips for [FEI/Philips](#), [ZEISS/LEO](#), [Cambridge](#) each

S583/1 100mm Ø x std pin stub with 1 clip for [FEI/Philips](#), [ZEISS/LEO](#), [Cambridge](#) each
S583/2 100mm Ø x std pin stub with 2 clips for [FEI/Philips](#), [ZEISS/LEO](#), [Cambridge](#) each
S583/3 100mm Ø x std pin stub with 3 clips for [FEI/Philips](#), [ZEISS/LEO](#), [Cambridge](#) each
S583/4 100mm Ø x std pin stub with 4 clips for [FEI/Philips](#), [ZEISS/LEO](#), [Cambridge](#) each
S583/8 100mm Ø x std pin stub with 8 clips for [FEI/Philips](#), [ZEISS/LEO](#), [Cambridge](#) each

S-Clips 45° & 90° on 25.4mm Ø & 12.7mm Ø Pin Stubs

S589 S-Clip sample holder with 1 clip 45° on [25.4mm Ø](#) pin stub each
S590 S-Clip sample holder swivel mount with 1 S-Clip on [25.4mm Ø](#) pin stub each
S591 S-Clip sample holder with 2x S-Clips 45°/90° on [25.4mm Ø](#) pin stub each
S592 S-Clip sample holder with 2x S-Clips double 90° on [25.4mm Ø](#) pin stub each
S593 S-Clip sample holder with 1x S-Clip at 90° on [12.7mm Ø](#) pin stub each
S594 S-Clip sample holder with 4x S-Clips at 90° on [12.7mm Ø](#) pin stub each
S595 S-Clip sample holder with 4x S-Clips at 45° & 90° on pin stub each
S596 S-Clip sample holder with 10x S-Clips at 90° on 10 x 50mm pin stub each

S-Clips on M4 Hitachi Stubs

S597 S-Clip sample holder with 1x S-Clip on 15mm Ø x 10mm stub, M4 each
S598 S-Clip sample holder with 1x S-Clip on 25mm Ø x 10mm stub, M4 each
S598/2 S-Clip sample holder with 2x S-Clip on 25mm Ø x 10mm stub, M4 each
S598/3 S-Clip sample holder with 3x S-Clip on 25mm Ø x 10mm stub, M4 each

S599 S-Clip sample holder with 1x S-Clip on 32mm Ø x 10mm stub, M4 each
S599/2 S-Clip sample holder with 2x S-Clip on 32mm Ø x 10mm stub, M4 each
S599/3 S-Clip sample holder with 3x S-Clip on 32mm Ø x 10mm stub, M4 each

S630 S-Clip sample holder with 1x S-Clip on 50mm Ø x 6mm stub, M4 each
S630/2 S-Clip sample holder with 2x S-Clip on 50mm Ø x 6mm stub, M4 each
S630/3 S-Clip sample holder with 3x S-Clip on 50mm Ø x 6mm stub, M4 each
S630/4 S-Clip sample holder with 4x S-Clip on 50mm Ø x 6mm stub, M4 each

S631 S-Clip sample holder with 1x S-Clip on 63mm Ø x 6mm stub, M4 each
S631/2 S-Clip sample holder with 2x S-Clip on 63mm Ø x 6mm stub, M4 each
S631/3 S-Clip sample holder with 3x S-Clip on 63mm Ø x 6mm stub, M4 each
S631/4 S-Clip sample holder with 4x S-Clip on 63mm Ø x 6mm stub, M4 each
S631/8 S-Clip sample holder with 8x S-Clip on 63mm Ø x 6mm stub, M4 each

S632 S-Clip sample holder with 1x S-Clip on 100mm Ø x 6mm stub, M4 each
S632/2 S-Clip sample holder with 2x S-Clip on 100mm Ø x 6mm stub, M4 each
S632/3 S-Clip sample holder with 3x S-Clip on 100mm Ø x 6mm stub, M4 each
S632/4 S-Clip sample holder with 4x S-Clip on 100mm Ø x 6mm stub, M4 each
S632/8 S-Clip sample holder with 8x S-Clip on 100mm Ø x 6mm stub, M4 each

S-Clips on M4 Hitachi Stubs 45° & 90°

- S633** S-Clip sample holder 45° with 1x S-Clip on 25mm Ø stub M4 each
S634 S-Clip sample holder 45°/90° with 2x S-Clip on 25mm Ø stub M4 each
S634/A S-Clip sample holder double 90° with 2x S-Clip on 25mm stub M4 each
S635 S-Clip sample holder 90° with 4x S-Clip on 12.7x12.7mm Ø stub M4 each
S636 S-Clip sample holder with 4x S-Clips at 45° & 4x S-Clips at 90°, M4 each
S637 S-Clip sample holder with 10x S-Clips at 90°, 10x50mm, stub M4 each



Spare S-Clip Screws & Elevating Blocks

- S638** 5 Copper alloy S-Clips with 5 each brass M2 x 3mm screws set
S639 6 each S-Clip elevating pillars, 4mm height, M2 x3mm male/female set



S-Clips on Flat JEOL Specimen Stubs

- S640** S-Clip sample holder with 1x S-Clip on 25mm Ø x 10mm JEOL SEM stub each
S640/2 S-Clip sample holder with 2x S-Clip on 25mm Ø x 10mm JEOL SEM stub each
S640/3 S-Clip sample holder with 3x S-Clip on 25mm Ø x 10mm JEOL SEM stub each
S641 S-Clip sample holder with 1x S-Clip on 32mm Ø x 10mm JEOL SEM stub each
S641/2 S-Clip sample holder with 2x S-Clip on 32mm Ø x 10mm JEOL SEM stub each
S641/3 S-Clip sample holder with 3x S-Clip on 32mm Ø x 10mm JEOL SEM stub each



- S642** S-Clip sample holder with 1x S-Clip on 50mm Ø x 5mm JEOL SEM stub each
S642/2 S-Clip sample holder with 2x S-Clip on 50mm Ø x 5mm JEOL SEM stub each
S642/3 S-Clip sample holder with 3x S-Clip on 50mm Ø x 5mm JEOL SEM stub each
S642/4 S-Clip sample holder with 4x S-Clip on 50mm Ø x 5mm JEOL SEM stub each
S646 Swivel mount sample holder with 1 clip on 15mm Ø plate on 12.2mm Ø JEOL stub each



S-Clips on 45° & 90° JEOL Stubs

- S643** S-Clip sample holder with 1x S-Clip on 45° x 25mm Ø JEOL stub each
S644 S-Clip sample holder with 2x S-Clips at 45° & 90° on 25mm Ø JEOL stub each
S645 S-Clip sample holder with 2x S-Clips double 90° on 25mm Ø JEOL stub each



Stub Gripper Tweezers

The EM-Tec SEM stub tweezers securely grip SEM stubs and mounts to avoid touching them by hand to eliminate contamination issues. They are made from *anti-magnetic stainless steel* and are clean room compatible. They are excellent quality at an affordable price **and are available for:**

- All **grooved pin stubs** with 12.7, 19, 25.4 and 32mm head diameters (45° handle angle)
T600 anti-magnetic S/S tweezers for grooved pin stubs 12.7mm Ø 120mm long each
T601 anti-magnetic S/S tweezers for grooved pin stubs 19mm Ø 120mm long each
T602 anti-magnetic S/S tweezers for grooved pin stubs 25.4mm Ø 120mm long each
T603 anti-magnetic S/S tweezers for grooved pin stubs 32mm Ø 115mm long each
All **JEOL cylinder stubs** with 9.5, 12.2, 25.4 and 32mm head diameters (30° handle angle)
T604 anti-mag S/S grippers for 9.5mm Ø JEOL cylinder stubs 114mm long each
T605 anti-mag S/S grippers for 12.2mm Ø JEOL cylinder stubs 120mm long each
T606 anti-mag S/S grippers for 15mm Ø JEOL cylinder stubs 120mm long each
T607 anti-mag S/S grippers for 25mm Ø JEOL cylinder stubs 115mm long each
T608 anti-mag S/S grippers for 32mm Ø JEOL cylinder stubs 115mm long each
All **Hitachi cylinder stubs** with 15, 25 and 32mm head diameters (30° handle angle)
T609 anti-mag S/S grippers for 15mm Ø Hitachi & ISI cylinder stubs 120mm long each
T610 anti-mag S/S grippers for 25mm Ø Hitachi & ISI cylinder stubs 120mm long each
T611 anti-mag S/S grippers for 32mm Ø Hitachi & ISI cylinder stubs 120mm long each



SEM Sample Stub Adapters

SEM stub adapters enable the use of all common types of SEM stubs or mounts in your SEM

JEOL to Hitachi Stub Adapters



- S784** J10H JEOL 9.5mm Ø adapter for M4 Hitachi stubs 9.5 x 9.5mm Ø.
S785 J12H JEOL 12.2mm Ø adapter for M4 Hitachi stubs 12.2 Ø x 10mm
S786 J25H JEOL 25mm Ø adapter for M4 Hitachi stubs 25mm Ø x 10mm

Hitachi to JEOL Stub Adapters



- S787** HJ10 Hitachi M4 adapter for JEOL stubs 9.5mm Ø.
S788 HJ11 Hitachi M4 adapter for JEOL stubs 12.2mm Ø
S789 HJ12 Hitachi M4 adapter for JEOL stubs 15mm Ø
S790 HJ25 Hitachi M4 adapter for JEOL stubs 25mm Ø
S791 HJ32 Hitachi M4 adapter for JEOL stubs 32mm Ø
S792 HJ50 Hitachi M4 adapter for JEOL stubs 50mm Ø

Pin stub adapters for using different SEM stubs in pin type SEMs such as FEI, Philips, Tescan, Phenom, Aspex, Cambridge Instruments, Leica, etc.

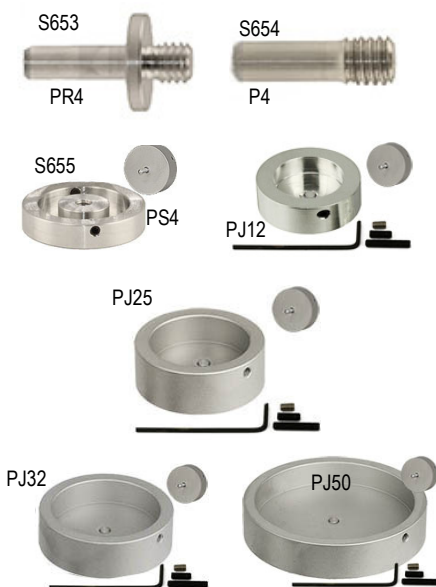

- S653** PR4 pin (3.2 x 9.5mm) stub adapter for Hitachi M4 with support rim for larger stubs/holders 9mm Ø x 15mm deep each
S654 P4 pin (3.2 x 9.5mm) stub adapter for Hitachi M4 straight for smaller stubs/holders 4mm Ø x 13.5mm deep each
S655 PS4 pin (3.2 x 9.5mm) stub adapter for Cambridge S4 mounts 30mm Ø x 19.5mm deep each
S656 PJ12 pin stub adapter for 12.2 and 9.5mm Ø JEOL stubs. Accepts up to 16mm Ø cylinder stubs. Can also be used for Hitachi 15mm Ø and 15mm Ø ISI/ABT/Topcon stubs. Has set screw to secure the SEM stubs. Overall size 25mm Ø x 19.5mm. Includes Allen key.
S657 PJ25 pin stub adapter for 25mm Ø JEOL & Hitachi stubs. This adapter accepts up to 25mm Ø cylinder stubs. Can also be used for the Hitachi 25mm Ø stubs or 25mm Ø/1inch metallographic mounts. Set screw is used to secure the stubs. Machined from vacuum grade aluminium. Overall size Ø34x19.5mm. Includes Allen key.
S658 PJ32 pin stub adapter for 32mm Ø JEOL & Hitachi stubs. This adapter accepts up to 32mm Ø cylinder stubs. Can also be used for the Hitachi 32mm Ø stubs or 30mm Ø/1.25 inch metallographic mounts. Set screw is used to secure the stubs. Machined from vacuum grade aluminium. Overall size Ø40 x 19.5mm. Includes Allen key.
S659 PJ50 pin stub adapter for 50mm Ø JEOL & Hitachi stubs. This adapter accepts up to 50mm Ø cylinder stubs. Can also be used for the Hitachi 50mm Ø stubs or 50mm Ø/2 inch metallographic mounts. Set screw is used to secure the stubs. Machined from vacuum grade aluminium. Overall size 59mm Ø x 19.5mm. Includes Allen key.

Pin Stub Adapter for Incident Light/Reflected Microscope Observation



S797 M31P metal slide adapter to accommodate standard and short Zeiss pin stubs on upright reflected/incident light microscopes. Top part accepts the 3.2mm pin of the pin stubs. Designed for pin stubs up to 25.4mm diameter, but will work with pin stubs of 32 and 38mm as well. Pin stub can be secured with a stainless steel M3 screw. Overall size is 76.2 x 25.4 x 11.2mm. Made from black metal anodised aluminium slide with a 25mm aluminium pin stub adapter.

Zeiss short pin stub adapters for using different SEM stubs in Zeiss and LEO SEMs.
Pin stub adapters with the longer pin can be easily modified for use on Zeiss & LEO SEMs.

S647 ZR4 Zeiss pin stub adapter for **Hitachi M4** with support rim. Suitable for larger SEM stubs and larger SEM holders with M4 thread. Used on Zeiss and LEO SEMs. Pin is standard **3.2mm Ø and 6mm** long. The support rim has a 9mm Ø to give extra stability for larger SEM stubs and holders. Machined from vacuum grade aluminium. Overall size is 9mm Ø x 11.5mm.

S648 Z4 Zeiss pin stub adapter to **Hitachi M4** for smaller SEM stubs and SEM holders with M4 thread. Used on Zeiss and LEO SEMs. Pin is standard 3.2mm diameter and 6mm long. Small design where the head of the adapter fits in the M4 thread. Machined from vacuum grade aluminium. Overall size is 4mm Ø x 10mm.

S649 ZJ12 Zeiss pin stub adapter for 12.2mm and 9.5mm Ø **JEOL** stubs. This stub adapter accepts up to 16mm Ø cylinder stubs. Can also be used for the **Hitachi** and **ISI/ABT/Topcon** 15mm Ø stubs. Set screw is used to secure the stubs. Machined from vacuum grade aluminium. Overall size Ø25x16mm. Includes Allen key.

S650 ZJ25 Zeiss pin stub adapter for 25mm Ø **JEOL** stubs. This stub adapter accepts up to 25mm Ø cylinder stubs. Can also be used for the **Hitachi** 25mm/1" Ø stubs or 25mm Ø/1" metallographic mounts. Set screw is used to secure the stubs. Machined from vacuum grade aluminium. Overall size Ø34x16mm. Includes Allen key.

S651 ZJ32 Zeiss pin stub adapter for 32mm Ø **JEOL** stubs. This stub adapter accepts up to 32mm Ø cylinder stubs. Can also be used for the **Hitachi** 32mm/1" Ø stubs or 30mm Ø/1.25" metallographic mounts. Set screw is used to secure the stubs. Machined from vacuum grade aluminium. Overall size Ø34x16mm. Includes Allen key.

S652 ZJ50 Zeiss pin stub adapter for 50mm Ø **JEOL** stubs. This stub adapter accepts up to 50mm Ø cylinder stubs. Can also be used for the 50 mm/2" Ø stubs or 30mm Ø/2" metallographic mounts. Set screw is used to secure the stubs. Machined from vacuum grade aluminium. Overall size Ø34x16mm. Includes Allen key



Other Pin Stub Adapters

These adapters allow JEOL, ISI/ABT and Hitachi users to accommodate the standard pin stubs of the European and American manufacturers. The conversion cylinder contains a clip to hold the pin stub.

- S367** Converter for JEOL, 10mm Ø cylinder
- S367/1** Converter for JEOL, 12.5mm Ø cylinder
- S367/2** Converter for ISI/ABT, 15mm Ø cylinder
- S367/3** Converter for Hitachi, 15mm Ø cylinder with M4 internal thread

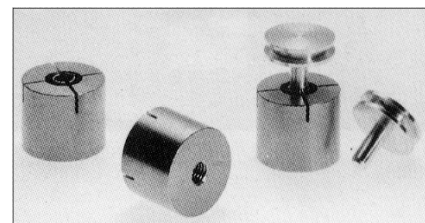

Gatan 3View sample pin stubs, tweezers and storage box

- G311** Gatan 3View system SEM pin stubs with standard 1.4mm Ø flat, 2mm Ø pin x12.5mm H, aluminium pack of 10
- G311/1** Gatan 3View system SEM pin stubs with standard 1.4mm Ø flat, 2mm Ø pin x12.5mm H, aluminium pack of 50
- G213** Gatan 3View system SEM pin stubs with large 2.4mm Ø flat, 2mm Ø pin x12.5mm H, aluminium pack of 10
- G312/1** Gatan 3View system SEM pin stubs with large 2.4mm Ø flat, 2mm Ø pin x12.5mm H, aluminium pack of 50
- T612** Gatan 3View stub handling tweezers, 118mm, anti-magnetic S/S each
- B581** PS28 storage box for 28 Gatan 3View pin stubs each

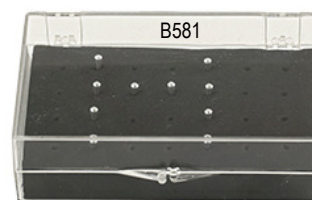

SEM Multiple Stub Holders

Our multiple pin stub holders are an efficient and cost-effective way to load multiple pin stubs with specimens in the SEM. Saves time, allows multi sample processing or quick comparison between samples. Intended for holding the standard 12.7mm (1/2") pin stubs, although the larger 25.4mm (1") pin stubs can be used on the holders for 6 pin stubs or more. All the positions on the holders for 6 pin stubs or more are **numbered** for easy identification and stubs are securely held with small M3 stainless steel set screws for the multi pin stub holders up to 12 pin stubs; an Allen key is included. On the 29 and 49 multi pin stub holders, the pin stubs are held with an integrated stainless steel spring. The 6 and 8 multi pin holders comprise engraved crossed lines to assist with directional navigation. They are all made from vacuum grade aluminium and have undergone a final cleaning step which results in a satin surface finish. Available with **standard pin** to fit FEI, Philips, Tescan, Phenom, Aspex, RJ Lee, Amray, Cambridge Instruments, Leica, CamScan, Aspex, ETEC and Novascan SEMs.

M4 threaded hole compatible with Hitachi SEMs, FESEMs and table top SEMs and **32mm JEOL SEM stub format** compatible with 32mm stub holders on JEOL SEMs. Additionally there are two **45° degrees pre-tilt multi-pin holders** available:

SEM Multi Pin Stub Holders on Standard Pin Base



Flat - Pin stubs 12.7 & 25.4mm Ø

- S662/4** P4 multi pin stub holder for 4 pin stubs, 31.5 mm Ø x 10.5mm, std pin each
S662/6 P6 multi pin stub holder for 6 pin stubs, 43mm Ø x 10.5mm, std pin each
S662/8 P8 multi pin stub holder for 8 pin stubs, 50mm Ø x 10.5mm, std pin each
S662/12 P12 multi pin stub holder for 12 pin stubs, 62mm Ø x 10.5mm, std pin each
S662/29 P29 multi pin stub holder for 29 pin stubs, 90mm Ø x 7mm, std pin each
S662/49 P49 multi pin stub holder for 49 pin stubs, 117mm Ø x 7mm, std pin each

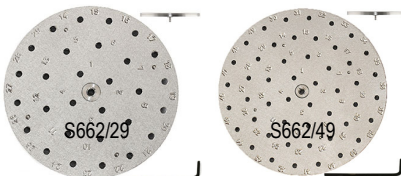

S663 P7 multi pin stub holder for 7 pin stubs 25.4mm Ø, 78mm Ø x 15mm, std pin each
 (No image)

Angled

- S664/3** P3/45 multi pin stub holder 45° for 3 pin stubs, 25mm Ø x 14mm, std pin each
S664/6 P6/45 multi pin stub holder 45° for 6 pin stubs, 35mm Ø x 14mm, std pin each



SEM Multiple Pin Stub Holders on M4 Hitachi Base



Flat - Pin stubs 12.7 & 25.4mm Ø

- S665/4** P4 multi pin stub holder for 4 pin stubs on M4 base 31mm Ø x 10.5mm each
S665/6 P6 multi pin stub holder for 6 pin stubs on M4 base 43mm Ø x 10.5mm each
S665/8 P8 multi pin stub holder for 8 pin stubs on M4 base 50mm Ø x 10.5mm each
S665/12 P12 multi pin stub holder for 12 pin stubs on M4 base 62mm Ø x 10.5mm each
S665/29 P29 multi pin stub holder for 29 pin stubs on M4 base 90mm Ø x 7mm each
S665/49 P49 multi pin stub holder for 49 pin stubs on M4 base 117mm Ø x 7mm each

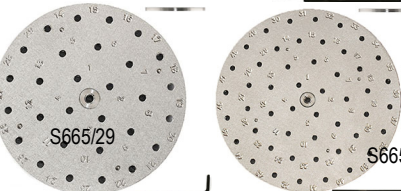

S666/7 P7 multi pin stub holder for 7 x 25.4mm Ø pin stubs, 78mm Ø 15mm M4 base each

Angled

- S667/3** P3/45° multi pin stub holder for 3 pin stubs, 25mm Ø x 14mm M4 base each
S667/6 P6/45° multi pin stub holder for 6 pin stubs, 35mm Ø x 14mm M4 base each

S668 Flat multi pin holder for 4 pin stubs 31.5mm Ø x 10.5mm on JEOL base each



Multiple Stub Holders for M4 Hitachi Stubs

Our multiple stub holders are an economical and simple way to load multiple Hitachi sample stubs with specimens in the SEM. Using multiple stub holders saves time, allows multi sample processing or allows quick comparison of samples. The horizontal multi stub holders are based on the 25mm Ø x 6mm x M4 and the 50mm Ø x 6mm x M4 Hitachi stubs to hold multiple stubs on M4 screws. The 45° multiple holders allow for a 45° pre-tilt which is beneficial for table top SEMs w/o a stage tilt or to quickly image under 45° w/o having to tilt the SEM stage. 45° tilted imaging tends to give a higher SE signal and reveals more of the topography of the specimen surface. The 45° multi stub holders are offered in two versions:

- Fixed M4 threaded screws to hold the Hitachi stubs
- Adjustable rotation M4 threaded screws for individual rotation of the Hitachi stubs to optimize viewing angle for the sample area

Flat

- S669** Multi stub holder for 3x15mm Ø M4 stubs, 25mm Øx6mm, 3.2mm Ø stage pin each
S670 Multi stub holder for 3x15mm Ø M4 stubs, 25mm Øx6mm with M4 thread each
S671 Multi stub holder for 3x25mm Ø M4 stubs, 50mm Øx6mm, 3.2mm Ø stage pin each
S672 Multi stub holder for 3x25mm Ø M4 stubs, 50mm Øx6mm with M4 thread each
S669/6 Multi stub holder for 6x15mm Ø M4 stubs, 50mm Øx6mm, 3.2mm Ø stage pin each
S670/6 Multi stub holder for 6x15mm Ø M4 stubs, 50mm Øx6mm with M4 thread each

Angled 45°

- S673** Multi holder 45° for 3x15mm Ø M4 stubs 25mm Ø x14mm, 3.2mm Ø stage pin each
S674 Multi stub holder for 3x15mm Ø M4 stubs, 25mm Øx14mm with M4 thread each
S673/6 Multi stub holder for 6x15mm Ø M4 stubs, 50mm Øx6mm, 3.2mm Ø stage pin each
S674/6 Multi stub holder for 6x15mm Ø M4 stubs, 50mm Øx6mm, with M4 thread each

45° Angled Stub Holders with Individual Rotation (IR)

Each M4 stub can be individually rotated to optimise the viewing angle for the sample area

- S675** Multi holder 45° IR for 3x15mm Ø M4 stubs, 25mm Øx14mm, std stage pin each
S676 Multi holder 45° IR for 3x15mm Ø M4 stubs, 25mm Øx14mm, M4 thread each
S675/6 Multi holder 45° IR for 6x15mm Ø M4 stubs, 35mm Øx14mm, std stage pin each
S676/6 Multi holder 45° IR for 6x15mm Ø M4 stubs, 35mm Øx14mm, M4 thread each

JEOL Multiple Cylinder Stub Holders

- S677** Multi stub holder for 4x 9.5mm Ø cylinder stubs 31.5mm Ø x 10mm deep each
S678 Multi stub holder for 3x 12.2mm Ø cylinder stubs 31.5mm Ø x 10mm deep each

JEOL multiple cylinder stub holders on standard (3.2mm Ø) pin base

- S679** Multi stub holder for 4x 9.5mm Ø cylinder stubs 31.5mm Ø x 10mm on std pin each
S680 Multi stub holder for 3x 12.2mm Ø cylinder stubs 31.5mm Ø x 10mm on std pin each
S681 Multi stub holder for 6x 12.2mm Ø cylinder stubs 50mm Ø x 10mm on std pin each

JEOL multiple cylinder stub holders on Hitachi M4 base

- S682** Multi stub holder for 4x 9.5mm Ø cylinder stubs 31.5mm Ø x 10mm M4 each
S683 Multi stub holder for 3x 12.2mm Ø cylinder stubs 31.5mm Ø x 10mm M4 each
S684 Multi stub holder for 6x 12.2mm Ø cylinder stubs 50mm Ø x 10mm M4 each



Gold Series SEM Sample Holders and Pin Stub Adapters

Our gold series SEM sample holders comprise a selection of compact holders, all made from brass and plated with 1µm of pure gold. Brass is chosen for greater strength and is fully non-magnetic. The gold plating assists in keeping the sample holders clean during handling. The superior chemical resistance of the gold plating facilitates the use of cleaning solutions or plasma cleaning. Clean sample holder surfaces will also greatly reduce contamination transfer to the samples. Intended for use with table top SEMs, laboratory grade SEMs and FESEMs.



Rectangular type bulk sample holder with pin (or M4) and two side brackets for sample thickness up to 16mm. Made from brass, 1µm thick gold plated. Ideal for smaller samples and smaller SEMs. Provided with 4 set screws.

S690 Bulk sample holder for up 16mm, gold plated brass, [Pin mount](#) each

S691 Bulk sample holder for up 16mm, gold plated brass, [M4 mount](#) each



Mini pin stub tube/needle clamp. Capacity up to 2mm Ø, the needle is secured with a small set screw. This holder is ideal for probes, needles, wire and thin tubes. Holder size is 6mm Ø x4mm. Made from brass and plated with 1µm of pure gold.

S692 Needle/tube sample holder for up to 2 mm Ø, gold plated brass, pin each



A swivel vice which covers a full 180° angle and can also be rotated with the stub. This is the ultimate holder for imaging cross sections at any desired angle. The swivel head size without clamping screws is only 16 x16 x 14mm. The sample is clamped with the two knurled clamping screws; the swivel head can be locked in place with the tilt clamping screw. Made from brass and plated with 1µm of pure gold.

S693 Swivel head sample holder for up 10mm samples, gold plated brass, pin each



Round type bulk sample holder with three brackets for round and awkwardly shaped samples up to 20mm Ø. Made from brass, 1µm thick gold plated. Ideal for smaller samples and smaller SEMs. Provided with 6 set screws.

S694 Bulk sample holder for up to 20mm Ø, gilded brass, [Pin mount](#) each

S695 Bulk sample holder for up to 20mm Ø, gilded brass, [M4 mount](#) each



Lightweight, spider like holder for awkwardly shaped samples up to 25mm Ø. Samples are supported by the three threaded legs and clamped by the flanges on the clamping nuts. Made from brass and plated with 1µm of pure gold.

S696 Spider type bulk sample holder for up to 25mm Ø, gold plated brass, [pin](#) each



Lightweight, spider like holder for awkwardly shaped samples up to 45mm Ø. Samples are supported by the three threaded legs and clamped by the flanges on the clamping nuts. Made from brass and plated with 1µm of pure gold.

S697 Spider type bulk sample holder for up to 45mm Ø, gold plated brass, pin each



Compact Zeiss pin stub adapter with M4 threaded head to convert stubs and sample holders with an M4 threaded hole to a Zeiss pin stub. Pin is 3.2mm diameter and 6mm long. Made from brass and plated with 1µm of pure gold.

S698 Compact Zeiss pin stub adapter with M4 thread, Au plated brass, short Zeiss pin each



Compact standard pin stub adapter with M4 threaded head to convert stubs and samples holders with an M4 threaded hole to a *standard pin stub*. Pin is 3.2mm diameter and 9.5mm long. Made from brass and plated with 1µm of pure gold.

S699 Compact standard pin stub adapter with M4 thread, gold plated brass, pin each

Universal SEM Sample Holder and SEM Stub Adapter Kit

The universal SEM sample holder and SEM stub adapter kit has been created to hold a wide variety of SEM samples up to 42mm. The samples can be flat, round, block or awkwardly shaped. Also included is a useful selection of SEM stub adapters which enables the kit to be used on virtually any SEM. Fully compatible with FEI/Philips, JEOL, Hitachi, Tescan, Zeiss/LEO and other brands of SEMs.

Ideally suited for:

- multi-user environments
- labs with different brands of SEMs
- labs with a large and changing variety of samples
- service labs to cope with different sample stubs
- portability between SEM platforms

The selection of SEM sample holders all include an M4 threaded hole. Fully compatible with the SEM stub adapters provided in this universal sample holder kit and with Hitachi SEMs.

Included SEM stub adapters in the kit are:

- pin stub adapters for FEI/Philips, Zeiss/LEO, Tescan, Amray
- a 12.2mm JEOL stub adapter with M4 screw
- a 12.2mm JEOL stub adapter for pin stubs
- Multi pin holder doubles as pin stub adapter for Hitachi SEMs.

List of included items: Compact vice clamp 0.22mm, Mini vice clamp 0.6mm, Multi holder for 4 pin stubs, Universal spring loaded vice holder up to 42mm, Bulk sample holder up to 32mm Ø, 3x S clip on 25mm Ø M4 stub, 2x S clip on 45/90° 25mm Ø M4 stub, Short pin stub adaptor with rim to M4, Std pin stub adaptor with rim to M4, Long pin stub adaptor with rim to M4, JEOL 12.2mm Ø stub to pin, JEOL 12.2mm Ø stub to M4.

The complete kit is presented in a high quality wooden box with all the SEM sample holder and adapters neatly arranged in a hard plastic insert. This kit can also be used to convert SEM sample stubs up to 32mm diameter to fit other SEM brands.

S475 Universal SEM sample holder and stub adapter kit in wooden box, complete with insert.



Details overleaf

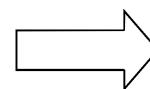

Vacu-Storr High Vacuum SEM Sample Storage Protect Sensitive Samples & Calibration Standards

Dimensions & Capacities of Vacu-Storr

Container	Vacu-Store Small	Vacu-Storr Medium	Vacu-Storr Large	Vacu-Storr X-large
Inside diameter	41mm	76mm	76mm	140mm
Outside diameter	54mm	85mm	90mm	153mm
Volume	40cc	320cc	680cc	3800cc
Top opening diameter	40mm	75mm	75mm	75mm
Inside useable height	30mm	71mm	150mm	305mm
Total height	95mm	140mm	190mm	350mm



EM-Storr Vacuum Storage & Shipping Container for FIB, SEM, TEM, & Calibration Specimens

The EM-Storr vacuum sample storage container has been specifically developed to store and protect SEM/FIB/TEM samples and calibration standards under vacuum. It protects valuable samples from air, moisture and dust. The superior EM-Storr vacuum container is constructed to the highest standards using high vacuum compatible materials, vacuum grade aluminium, a hardened safety glass lid, NBR O-ring and an all metal high vacuum valve with PTFE shaft seal. The outside of the aluminium container is hard anodised for protection. To reduce outgassing and to hold vacuum for extended periods, the inside surface is machined vacuum grade aluminium with a hardened glass lid. The EM-Storr vacuum desiccator is capable of reaching vacuum in the 10^{-4} mbar range. The vacuum connection for pump-down is a 6mm (1/4") barbed hose fitting – compatible with 6mm thick wall silicon vacuum hose. The EM-Storr vacuum containers are stackable and the octagonal design is optimised for handling, strength and weight.

Features

- Protects oxygen sensitive and/or moisture sensitive samples
- Protects samples and calibration standards against contamination
- Designed for SEM pin stubs and/or Hitachi M4 stubs
- Ideal for storing and transporting sensitive samples
- Clear hardened glass lid provides excellent vacuum seal
- Easy sample location through clear glass lid
- Sturdy, space-saving stackable and octagonal design

V106 EM-Storr vacuum sample storage container for 19 x 12.7mm Ø pin stubs

V107 EM-Storr vacuum sample storage container for 19 x 15mm Ø Hitachi stubs

V108 EM-Storr vacuum sample storage container for 60 TEM grids

V109 EM-Storr vacuum sample storage container for 100 FIB lift-out grids in box

V110 Replacement glass lid for EM-Storr vacuum sample container, 100mm Ø x 10mm



Vacu-Storr High Vacuum EM Sample Storage Containers

Protect Sensitive Samples & Calibration Standards

The Vacu-Storr high vacuum glass storage container have been especially developed for protecting materials and samples which are sensitive to dust, moisture, oxygen or other gases found in the environment. The containers consists of a soda lime glass jar, nickel plated aluminium lid, Viton O-ring seal and a metal sealed high vacuum valve. The high vacuum valve has a 6mm (1/4") barbed hose fitting to connect the hose to a vacuum pump or vacuum pumping system. The Vacu-Storr desiccators are capable of reaching a vacuum level of 10^{-4} mbar and expect to have an estimated vacuum holding time of 5 years to 100mbar. There are 4 sizes available, all supplied with a protective plastic netting and a protective polymer coating on the outside to prevent damage.

- | | | |
|-------------|-----------------------|-----------------|
| V111 | Vacu-Storr Small | Capacity 40ml |
| V112 | Vacu-Storr Medium | Capacity 320ml |
| V113 | Vacu-Storr Large | Capacity 680ml |
| V114 | Vacu-Storr Xtra Large | Capacity 3800ml |

Wafer Holders for SEM

Compatible with wafers with or without a notch

These wafer holders are specially designed to hold semi-conductor wafers in sizes of 100mm, 150mm and 200mm diameter (4 inch, 6 inch and 8 inch). They are compatible with wafers with either a flat or with a notch. The unique locking slide is adjustable to cope with non-standard wafers.

Unique features:

- low profile, weight balanced support disc
- square cut-outs for wafer tweezers
- adjustable spring tension
- adjustable for non-standard wafers
- self lubricating locking slide
- compatible with either wafers with a notch or wafers with a flat
- compatible with our stage adapters for all SEM platforms

Available with:

Standard pin to fit on SEMs FEI, Philips, Zeiss, LEO, Leica, Tescan, Aspex, R J Lee, AmRay, Cambridge Instruments, CamScan, ETEC and Novascan.

M4 threaded hole; compatible with Hitachi SEMs, FESEMs and table top SEMs **and** with the our versatile SEM stage adapters.

W106 **Standard pin** Wafer Holder for 100mm Ø (4")
W106/1 **M4 threaded hole** Wafer Holder 100mm Ø (4")

Dimensions without pin 106mm Ø x 16mm

W107 **Standard pin** Wafer Holder for 150mm Ø (6")
W107/1 **M4 threaded hole** Wafer Holder 150mm Ø (6")

Dimensions without pin 156mm Ø x 16mm

W108 **Standard pin** Wafer Holder for 200mm Ø (8")
W108/1 **M4 threaded hole** Wafer Holder 200mm Ø (8")

Dimensions without pin 206mm Ø x 16mm

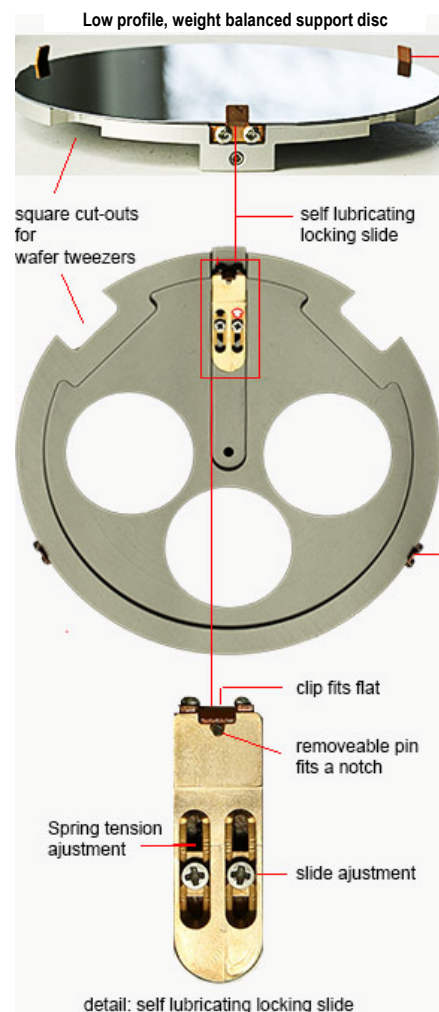

W106



W107



W108

Compact & Universal Vice Type SEM Sample Holders

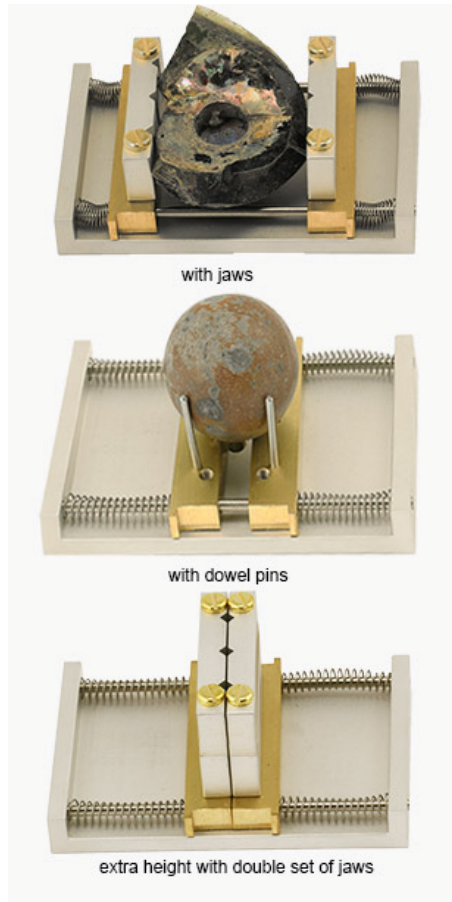

Vice type sample holders with a [standard pin](#) or [M4 threaded](#) hole are quick and easy to use holding the sample by clamping it between the moving jaws. They are especially useful when similar samples or a series of the same sample need to be examined. A vice clamps the sample and provides the rigidity needed for high resolution imaging and is a better alternative to adhesives or glue. All vice clamps are made from vacuum grade aluminium. Currently available items are:

- 1) Compact cost-effective vice sample holder for sample sizes up to 22mm using one fixed jaw and a spindle driven moving jaw. Can be used in both standard and table top SEMs. Brass spindle and stainless steel screws.
- 2) Single action spring-loaded vice for samples with a maximum clamping size of 12mm. The vice is opened by pushing the moving jaw with a push rod. The rod can be removed when the holder is loaded in the SEM. Dowel pins can be inserted in the fixed and moving jaws to increase the opening to a sample size up to 18mm diameter or to hold awkwardly shaped samples; 4 dowel pins are included. Stainless steel rods and springs.
- 3) Compact double action spring-loaded vice for samples with a maximum clamping size of 26mm. Due to the double sided spring, this vice acts as a centring vice. The jaws are opened by push rods which can be removed when the sample holder is loaded in the SEM. Dowel pins can be inserted in the jaws to increase the opening to a sample size up to 34mm diameter or to hold irregular shaped samples; 4 dowel pins are included. Stainless steel rods and springs.
- 4) Universal double sided spring-loaded larger vice for samples with a maximum size of 42mm. Different types of jaws can be mounted on this universal vice. Opens by pulling the jaws. Dowel pins can be inserted in the brass slider to extend the opening size and to hold awkwardly shaped samples. With the dowel pins a disc of up 50mm diameter can be held; 4 dowel pins are included. Includes triple grooved/smooth vice jaws. Additional optionally available vice jaws are:

Jaw with a single 120° large groove for round samples

Standard jaw with triple grooved/smooth side. vice jaws can be stacked to increase the jaw height from 12 to 24mm. Brass sliders and stainless steel rods and springs.

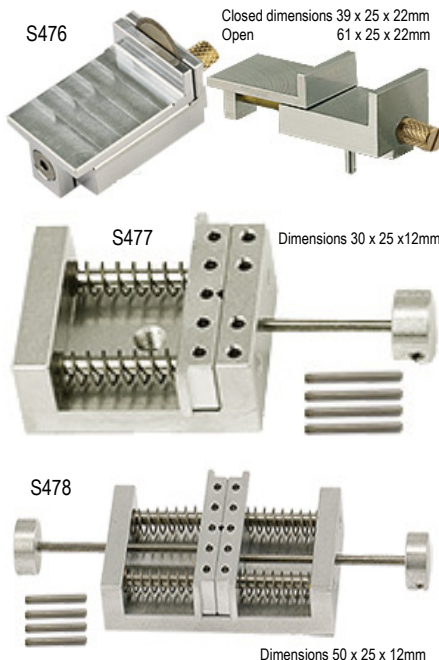

S476 Pin Vice clamp - Jaws open using a knurled brass knob for samples up to **22mm Ø**. Very thin samples can be securely held in this holder. For delicate samples, consider lining the jaws with conductive soft material (S480).

S476/1 As S476 but with [M4](#) threaded hole

S477 Pin single action spring-loaded vice clamp includes one removable push rod and four dowel pins which fit into the top of the jaws. The maximum clamping capacity between the vice jaws is **12mm**. Clamping size increases to **18mm** with dowel pins.

S477/1 As S477 but with [M4](#) threaded hole

S478 Pin base dual action spring-loaded vice clamp includes two removable push rods and four dowel pins which fit into the top of the jaws. The maximum clamping capacity between the vice jaws is **26mm**. Clamping size increases to **34mm** with dowel pins.

S478/1 As S478 with [M4](#) threaded hole

S479 Pin base dual action spring-loaded vice clamp includes two removable push rods and four dowel pins which fit into the top of the jaws. The maximum clamping capacity between the jaws is **42mm**. The aluminium vice plates have reversible jaws with a smooth side and a side with three small grooves. The grooves are more suitable for small round samples or to hold samples with a rough sides. Maximum sample capacity between dowel pins is **50mm**.

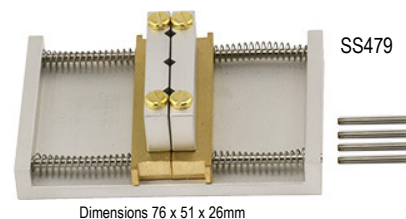

S479/1 As S479 with **M4** threaded hole

S479/T Standard triple groove/smooth vice jaw, 12 x 40 x 6mm, each



S479/S Single large groove/smooth vice jaw, 12 x 40 x 6mm, each



Conductive soft jaw lining kit for vice type SEM sample holders Comprises a conductive neoprene rubber sheet with a conductive adhesive layer on one side. It is intended to hold more delicate samples and to prevent damage to sensitive surfaces. The conductive medium soft rubber provides both a soft grip and a path to earth. This kit has been designed for use on all vice type holders. It comes as one piece and can be cut to size as required. After use it can be easily replaced or removed from the vice jaws (use acetone/isopropanol for cleaning). Supplied as a sheet which holds enough material to cut 5-6 sets of soft jaw linings.



S480 Conductive soft jaw lining kit for vice type SEM sample holders, 50x120mm sheet



Large Versatile Vice Clamp Sample Holders

These holders are large vice clamps with movable jaws and can accommodate large, heavy or multiple samples. They are designed for SEMs with large sample stages. The holders consist of a base plate with two parallel rows of holes to position the vice jaws at 10mm intervals for optimum sample compatibility. Made from vacuum grade aluminium with brass mounting screws and steel clamping screws. The sample can be adequately held using the clamping screws. Two sets of 3 screws with 10mm and 16mm length are provided with each vice clamp plate. The holders are freely configurable. There are **two** models to fit various sample sizes:

- V80 versatile vice clamp holder - for samples up to 80mm
- V120 versatile vice clamp holder – for samples up to 120mm.
Additional jaws can be added to mount multiple samples in the same holder. Currently, there are three types of vice clamps available:
 - standard vice clamp plates with 12mm height
 - optional grooved vice clamp plates with 16mm height
 - height extension clamp plates with 12mm height. Mount one or two additional extension clamps to increase the height to 24mm or even 36mm. The standard and height extension vice clamp plates can be mounted either way to optimise the height of the set screws.

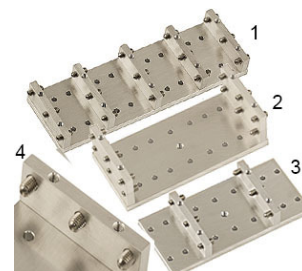

S700 Versatile vice clamp sample holder for up to 80mm **pin stub**

S701 Versatile vice clamp sample holder for up to 80mm **M4 threaded hole**

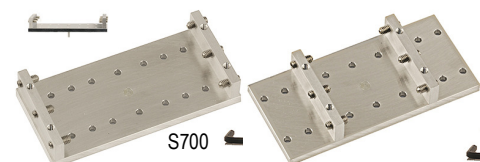

S702 Versatile vice clamp sample holder for up to 120mm **pin stub**

S703 Versatile vice clamp sample holder for up to 120mm **M4 threaded hole**



Additional adjustable clamps next page

With extra clamp plates (not included)

Additional Clamping Jaws for Large Versatile Specimen Clamps



S704

S704 VC12 standard vice jaw plate 12 x 44 x 5mm incl. set screws.

The vice jaw plates can be mounted either way to optimise the height of the clamping screws. When the plates are attached in the standard position, the clamping screws are in a higher position. Attach the plates upside down, and the clamping screw will be in a lower position.

Multiple vice clamps can be used on one vice base plate. The jaw plates can be mounted on the base plate at 10mm intervals to maximise sample size compatibility.

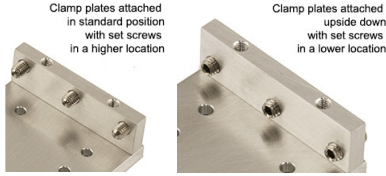

S705 VC16 grooved jaw plate 16 x 44 x 5mm incl. set screws

The grooved vice clamping plates can be mounted either way to optimise the height of the clamping screws. When the grooved vice clamping plates are attached in the standard position, the clamping screws are in a higher position. Attach the grooved clamping plates upside down and the clamping screw will be in a lower position.

Multiple vice clamping plates can be used on one vice base plate. The vice clamping plates can be mounted on the base plate in 10mm intervals to maximise sample size.

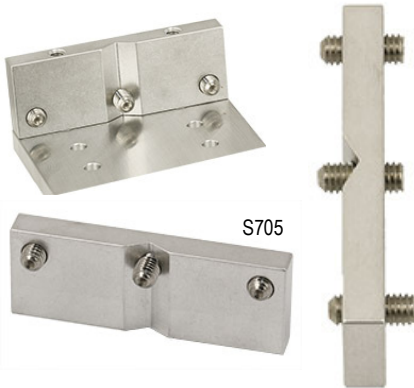

S705

S706 VH12 height extension clamping plate for VC12 with mounting screws, incl. set screws

Height extension vice clamp with 12mm height and 3 set screws. Can be mounted on top of the standard or grooved vice clamps to increase the clamp height to 24 or even 30mm. The vice clamps can be mounted either way to optimize the height of the set screws.

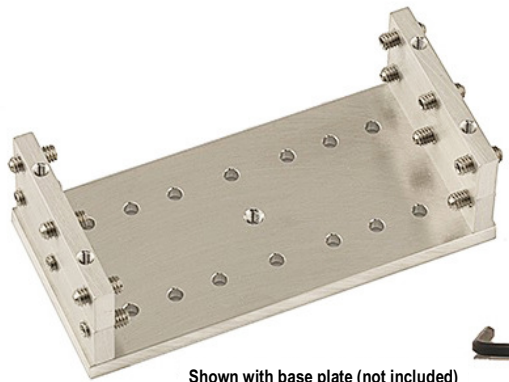

Shown with base plate (not included)



S706

New Range of Swivel/Tilt Sample Holders



A new range of swivel tilt sample holders which enable the clamping of small and thin samples has been added to the existing selection. These swivel/tilt holders allow for quick and easy tilting in both directions. The full range of the swivel/tilt holders are available for pin stub holders, Hitachi SEMs with M4 thread and JEOL SEMs with a 12.2mm stub holder. Ideal for adding tilt facilities to table top SEMs.

Mini Swivel SEM Vice Holders $\pm 90^\circ$

For up to 4mm \varnothing Samples

- S713 Mini aluminium swivel/tilt holder for up to 4mm sample [std pin stub](#)
- S714 Mini aluminium swivel/tilt holder for up to 4mm sample [JEOL 12.2mm \$\varnothing\$ mount](#)
- S715 Mini aluminium swivel/tilt holder for up to 4mm sample [Hitachi M4 mount](#)



For up to 8mm Samples

- S716 Mini aluminium swivel/tilt holder for up to 8mm sample [std pin stub](#)
- S717 Mini aluminium swivel/tilt holder for up to 8mm sample [JEOL 12.2mm \$\varnothing\$ mount](#)
- S718 Mini aluminium swivel/tilt holder for up to 8mm sample [Hitachi M4 mount](#)



For up to 16mm Samples

- S719 Mini aluminium swivel/tilt holder for up to 16mm sample [std pin stub](#)
- S720 Mini aluminium swivel/tilt holder for up to 16mm sample [JEOL 12.2mm \$\varnothing\$ mount](#)
- S721 Mini aluminium swivel/tilt holder for up to 16mm sample [Hitachi M4 mount](#)



Swivel Mount Adaptors

- S722 Aluminium swivel mount [pin](#) adaptor for [M4](#) stub
- S723 Aluminium swivel mount adaptor for [M4](#) to [M4](#) stub
- S724 Aluminium swivel mount adaptor for [JEOL 12.2mm \$\varnothing\$](#) to [M4](#) stub

Gold Plated Brass Swivel 10mm Clamping Mounts

Swivel vice GS10 is for larger samples and cross sections from [0-10mm](#); also allows mounting two cross sections at the time. This is the ultimate holder for imaging cross sections at any desired angle. The swivel head size without clamping screws is only 16 x 16 x 14mm. The sample is clamped with the two clamping screws; the swivel head can be locked in place with the tilt clamping screw. Made from gold plated brass. Also available as HG10 for Hitachi SEM and JG10 for JEOL SEMs.

- S725 Gold plated swivel mount sample holder for up to 10mm on pin base
- S726 Gold plated swivel mount sample holder for up to 10mm on M4 base
- S727 Gold plated swivel sample holder for up to 10mm on 12.2mm \varnothing JEOL base



Versatile 360°/90° off-set sample holder and 90° Quick-Flip holders

90° sample holder and 90° quick-flip kits

These allow the imaging of samples and samples mounted on stubs directly under 90° tilt w/o disturbing background. The 90° sample holder kit has a low profile and small volume to reduce interference with detectors. With the 90° pre-tilt there is no need to tilt the SEM stage (which often runs into limitations on high tilt angles); the 90° sample holder kit avoids those limitations. The 90° mounted stub or sample can be easily rotated in the 90° block to enable quick changes of viewing angles.

Off-set strip

The off-set strip brings the 90° holder away from the centre of the stage. As a result, a sample or sample stub mounted at 90° is positioned closer to the centre of the stage. This allows for easy rotation of the sample (in the X-Y plane). [Also very useful for table-top SEMs which have been configured with simple sample stages lacking tilt and rotation.](#)

90° sample imaging

An additional feature of the 90° holder is the ability to accept a needle with a shaft diameter up to 3.2mm. Samples can be mounted on the needle and easily imaged from different angles by manually rotating the needle in the holder. Due to the long distance from sample to sample stage, there are little or no disturbing background features. To fully reduce background signal, you could place a silicon wafer or carbon disc on the off-set strip directly underneath the sample. The vertical distance to the centre of the stub connection is 16mm which makes this holder kit compatible with pin stubs and Hitachi M4 stubs up to 32mm diameter.

360°/90° offset sample holder kit items and configurations

This kit is truly versatile and fully compatible with all standard SEMs such as FEI and Tescan, Zeiss SEMs with short pin, Hitachi SEMs and with the most SEM stage adaptors. For use on JEOL SEMs, a JEOL pin stub adaptor needs to be used. It can be used in a large variety of configurations. Overall size of the compact 360°/90° offset sample holder is only 36x25x12.7mm.

Off-set sample strip dimensions are: 36x12.7x5mm. 90° sample holder post dimensions are: 12.7x12.7x20mm

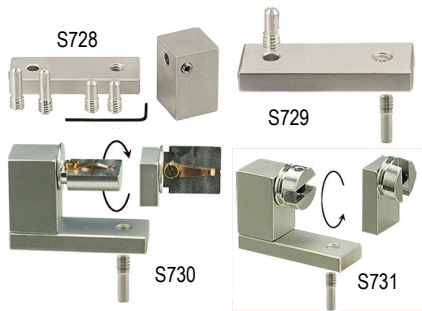

360°/90° Off-Set Sample Holders cont..

- S728** PH90 versatile off-set and 90° sample holder kit
S729 PH23 versatile *off-set strip only*, compatible with pin & M4
S730 PH91 Quick-Flip S-Clip 90° sample holder kit for pin & M4 for Si chips & thin samples
S731 PH92 Quick-Flip mini vice clamp 90° sample holder for pin & M4 samples up to 4mm
S732 PH93 Quick-Flip for thin samples and & samples up to 8mm thickness for pin & M4
S733 PH94 Quick-Flip for samples up to 16mm thickness for pin & M4



Quadruple Vice Holder

- S734** Pin stub vice holder type PS44 for up to 4 samples 0-4mm in size

STEM Imaging Holder



The STEM imaging holder is a cost effective method of adding STEM capabilities to your SEM at a fraction of the cost of a dedicated STEM holder and detector. The holder provides a genuine signal from the converted transmitted electrons, resulting in high contrast STEM imaging. The limiting factors are sample thickness and the accelerating voltage of the SEM.

The height of the holder is 29.5mm; with the electron absorption sleeve this increases to 37.5mm

The ST1 STEM imaging holder facilitates STEM imaging of TEM samples in an SEM or FESEM. The holder uses the Everhart-Thornley SE detector in the SEM chamber. The TEM grid is placed in the STEM imaging holder and the holder is positioned under the electron beam (typically in the centre of the SEM stage). The TEM sample is scanned with the electron beam and the STEM image is formed by converting the transmitted electrons, which hit the platinum conversion plate, into secondary electrons. The secondary electrons (holding the STEM image information) are collected by the SE detector in the sample chamber. It is advised to use high accelerating voltages (25-30kV) and thin samples to increase the transmitted electron signal. The STEM imaging detector is provided with a black conductive plastic electron absorption sleeve which is placed between the pole piece and the ST1 STEM imaging holder. The sleeve absorbs the secondary and backscattered electrons emitting from the sample surface.

Constructed from vacuum grade aluminium, brass TEM grid holder, platinum electron conversion plate and conductive plastic sleeve. Platinum is used for the conversion due to its high secondary electron signal, stability and corrosion resistance.

- S735** ST1 Stem Imaging holder for 1 x 3mm grid on standard 3.2mm pin base
S736 ST1 Stem Imaging holder for 1 x 3mm grid on M4 thread base

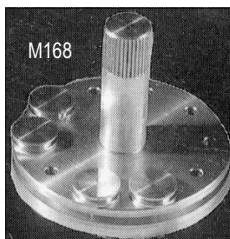

Preparation Stand for SEM Specimens

A cylindrical aluminium block for holding up to 10 specimen mounts for attachment of, or manipulation of samples. A rubber 'O' ring retains the mounts.

- M168** Mounting block - pin stubs each
M169 Mounting block - 10mm cylinders each

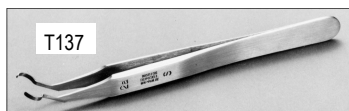

Tweezers for Stubs

Tweezers specially designed for handling ½" specimen stubs commonly used in SEM.

- T137** Tweezer for ½" stubs each
T330 SEM stub handling tool - A simple robust tool to fit 12.5mm pin stubs as an alternative to T137 suitably angled to allow convenient handling of the stubs in confined areas. The beryllium copper prongs allow a firm grip to be repeatedly achieved without loss of spring tension.

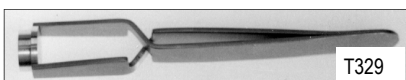
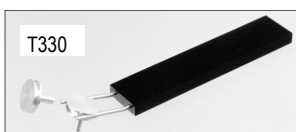

Tweezer for Hitachi Stubs

- T329** Special tweezer for handling 15mm Ø Hitachi stubs each