

## Microtomes

TAAB is now pleased to offer the range of RMC (Research Manufacturing Corporation) rotary microtomes, from this leading US manufacturer. The specification and quality of these microtomes is second to none with service to match.

### MR2 & MR3 Rotary Microtomes

A pair of microtomes offering manual (MR2) or semi-automatic operation (MR3). Rigidly constructed with cross roller bearings for rigidity and lightness of movement.

#### Features include:

- \* Heavy base casting to reduce vibration
- \* Vertical cutting stroke with solid cross roller bearing specimen carriage
- \* Digital Section Counter Display
- \* Touch Screen Control Panel with Easy to Clean Membrane Switches
- \* Section Thickness range 0.5 - 60 microns
- \* Electronic Feed with Fast Return
- \* Separate Trim Control Function with Footswitch
- \* Preset Trim Setting for Fast Block Trimming
- \* Wide range of accessories for Histology, Materials and Forensic Applications
- \* MR2 & MR3 Supplied Complete with High/Low Profile Disposable Steel Blade Holder and Specimen Holder (choice of Cassette Clamp or Fixed Jaw Vice Clamp)
- \* Removable Waste Tray

#### Specifications:

Dimensions: H-279 mm x W-273 mm x L-457 mm Weight - 24.3 kg  
Maximum Specimen Size: 55 x 50 mm  
Cutting Stroke: 64 mm  
Retraction: 70 microns  
Electronic Feed of Knife Stage: 28 mm  
Handwheel Lock: Positive lock at 12:00 o'clock or 6:00 o'clock position  
Specimen Orientation: x and y axis with tilt plus rotation  
Power Supply: Input 100-240 VAC, 50/60 Hz, 0.8 Amps Output 24 VDC, 36 Watts

#### Additional Specifications for MR3:

Variable cutting speed from 0 – 400 mm/second  
Footswitch control for both Cut & Trim Functions

**M417** MR2 Rotary Microtome with Universal Cassette Clamp and Disposable knife holder

**M417/1** MR2 Rotary Microtome with Vice Specimen Clamp and Standard Knife Holder

**M418** MR3 Rotary Microtome with Universal Cassette Clamp and Disposable knife holder

**M418/1** MR3 Rotary Microtome with Vice Specimen Clamp and Standard Knife Holder

### Heavy Duty Rotary Microtomes

#### M419 MT-990 Motorised Precision Microtome

With motorized, programmable, automatic trim, the MT-990 microtome is a high-precision instrument for sectioning both hard and soft material. When paired with its CRT-900 cryo-sectioning attachment, this is the ideal instrument for polymer applications. A full range of specimen and knife holders is available to match all applications.

#### M420 AFM-990 Precision Motorised Microtome

This microtome is primarily intended for specimen surface preparation for: AFM, SPM, SEM, OM, FTIR. This microtome is also ideal for sectioning materials for Forensic, QC and Materials research applications.

Please ask for a personalised quote for these microtomes



**CRT-900 Cryo System** - please ask for details. Fits both RMC and Microm microtomes



## Microtome Knives and Accessories

### Leica

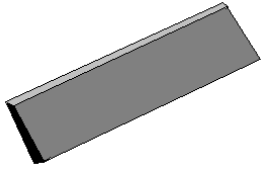

Microtome knife



DDK 16cm tungsten carbide knife

### Leica Standard Knives

All knives are now plain backed (not drilled & tapped for Shandon Knife Sharpener) Each B, C or D knife comes with its own box. *Please ask regarding resharpener of these knives.*

**Knife profile B** (plane/slightly concave for celloidin sections)

LL07831 Knife 25cm long profile B

**Knives profile C** (plane on both sides for paraffin and frozen sections)

LL07531 Knife 16cm long profile C

LL07545 Knife 22cm long profile C

LL07532 Knife 25cm long profile C

LL07128 Knife 30cm long profile C

LL04206 Knife 16cm long *tungsten carbide tipped* profile C

**Knives profile D** (chisel/tool edge for hard specimens and frozen sections)

LL04813 Knife 16cm long *tungsten carbide tipped* profile D

### Tungsten Carbide Knife Resharpener

LL90684 16cm TC profile C

LL90611 16cm TC profile D

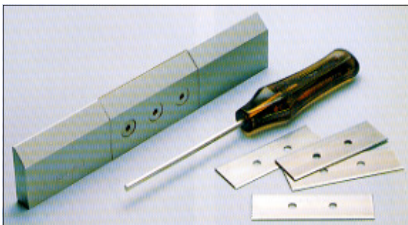

Technovit knives and holder

### Technovit Disposable Histoblade

(replaces Histoknife). Blades and holders

A completely new range of extra rigid blades with a 30° profile (was 40°) for plastic sectioning. Same dimensions as previous blade so existing holders can be used. Have much improved edge characteristics for better sectioning.

T553 Technovit Histoblades pack of 50

T398 Histoblade holder 17cm (for rotary microtomes)

T399 Histoblade holder 22cm (for sledge microtomes)

For knife holder for "Ralph" knives see K058/25 page 12.16

### Feather Disposable Blades



Feather disposable blades

Historically these disposable knives are often referred to as "Low Profile". This was to distinguish them from early Reichert-Jung (Leica) blades designed to fit the American 820 microtome which were deeper and therefore became known as "High Profile".

**A22** This blade permits the production of **very thin sections** in routine use and research and is suitable for fibrous tissues (biopsies/fabrics) and also for ribbon sectioning after trimming. It is very sharp (22° facet angle), and has a long service life.

Material: Stainless steel Facet angle: 22° Length: 80mm Height: 8mm

LL08300 Feather A22 disposable blades dispenser of 50 pieces

**A35** This disposable microtome blade allows the production of very thin sections and is suitable for **hard and soft tissues**. It is sharp and has a long service life.

Material: Stainless steel Facet angle: 35° Length: 80mm Height: 8mm

LL08000 Feather A35 disposable blades in dispenser of 50



**C35** Specifically designed for **cryostat use**, carbon steel with long service life

Material: Carbon steel Facet angle: 35° Length: 80mm Height: 8mm

LL31508 Feather C35 disposable *cryostat* blades dispenser of 20



**N35** This blade is particularly suitable for **hard tissues** and stands out for its long service life. It can also be used for soft tissues and biopsies and for ribbon sectioning after trimming. Trimming is slower but **compression is very low** and durability outstanding

Material: Stainless steel Facet angle: 35° Length: 80mm Height: 8mm

LL31506 Feather N35 disposable blade for hard tissue in dispenser of 50



**N35HR** Suitable for **hard tissue, routine** and **ribbon** sectioning. The new coating on this blade gives a cutting edge which is specially finished to ensure outstanding blade life and allow fast and easy section production.

Material: Stainless steel Facet angle: 35° Length: 80mm Height: 8mm

LL08200 Feather N35HR blade dispenser of 50

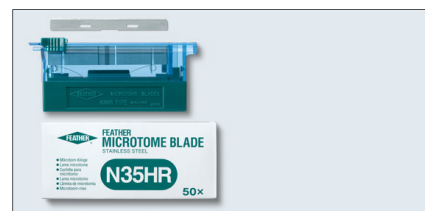

**R35** This blade is suitable for routine ribbon sectioning and for **hard tissues**, having a **specially hardened cutting edge**. It also offers rapid trimming times.

Material: Stainless steel Facet angle: 35° Length: 80mm Height: 8mm

LL31310 Feather R35 hardened steel disposable blade in dispenser of 50



**S22** This disposable microtome blade allows the production of **extra-thin sections** and is suitable for soft tissues and fabrics. Short trimming and long service life.

Material: Stainless steel Facet angle: 22° Length: 80mm Height: 8mm

LL31308 Feather disposable blade 22° for extra-thin sections dispenser of 50



**S35** The **standard** disposable microtome blade for **routine** practice and biopsies. High quality sections and short trimming times

Material: Stainless steel Facet angle: 35° Length: 80mm Height: 8mm

LL31309 Feather S35 routine disposable blade in dispenser of 50

LL31309/L Feather S35L routine blade **Long (120mm)** dispenser of 20

LL31309/LL Feather S35LL routine blade **Extra Long (180mm)** dispenser of 20



**High Profile** Blades for older Reichert-Jung and AO 820 microtomes

Material: Stainless steel Facet angle: 35° Length: 80mm Height: 14mm

LL12881 High profile Feather disposable blades dispenser of 50

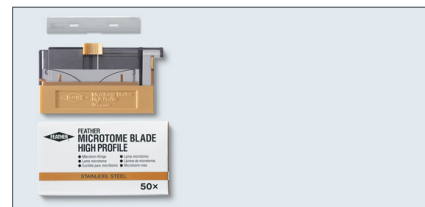

## Longer Disposable Blades



**S35L** 120mm length is particularly suitable for large blocks and routine sectioning.  
Material: Stainless steel Facet angle: 35° Length: 120mm Height: 8mm

LL31309/L S35L 120mm Feather blades in dispenser of 20 pieces



**S35LL** 180mm length for extra large blocks dispenser of 20 pieces  
Material: Stainless steel Facet angle: 35° Length: 180mm Height: 8mm

LL31309/LL S35LL 180mm Feather blades in dispenser of 20 pieces

## Lever Action Disposable Blade Holders

Blades can be easily replaced without tightening any screws

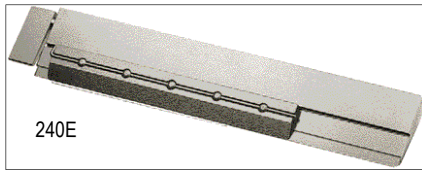

**240E** 240mm holder for *sliding* microtomes designed for sectioning large specimens.  
Can be used with S35L (120mm), S35 or R35 (80mm) disposable blades.

LL09428 240mm blade holder for *sliding* microtomes with fast lever clamping

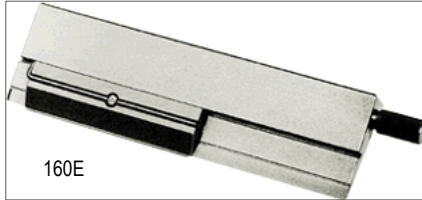

**160E** 160mm holder for *sliding* microtomes with fast action clamp.

LL09429 160mm disposable blade holder for *sliding* microtomes with lever action

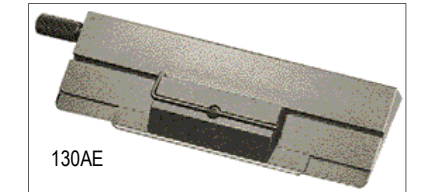

**130AE** 130mm holder for *rotary* microtomes with fast action clamp.

LL09430 130mm disposable blade holder for *rotary* microtomes with lever action

## Standard Disposable Blade Holders

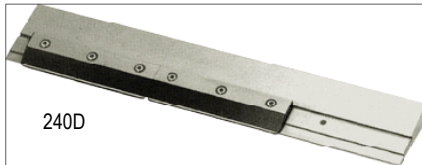

**240D** 240mm holder for *sliding* microtomes designed for sectioning large specimens.  
Can be used with S35 or R35 (80mm) disposable blades. Both trimming and sectioning are possible on the one holder.

LL09425/D 240mm standard disposable blade holder for *sliding* microtomes

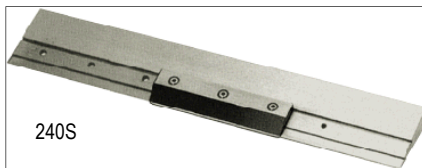

**240S** 240mm holder for *sledge* microtomes. Has one blade fixing plate.

LL09425 240mm standard disposable holder for *sledge* microtomes

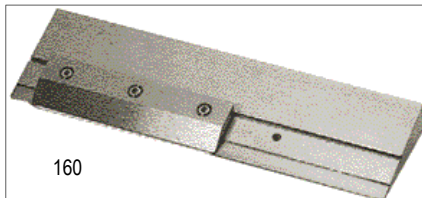

**160** The most popular holder. For *sliding* and *rotary* microtomes

LL09426 160mm Feather holder for *sliding* and *rotary* microtomes

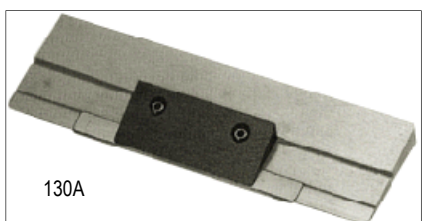

**130A** Standard Feather holder designed for *rotary* and *freezing* microtomes.

LL09427 130mm disposable blade holder for *rotary* and *freezing* microtomes

All holders manufactured from stainless steel



## Cryostat Disposable Blade Holders

- 130C-S** Blade holder 130mm for cryo-sectioning *with* ant-roll guide
- LL09431 Cryo-sectioning blade holder 130mm *with* anti-roll guide
- 130C-A** Blade holder 130mm for cryo-sectioning *without* anti-roll guide
- LL09432 Feather blade holder for cryo-sectioning *without* anti-roll guide
- 160C** A new model 160mm for cryo-sectioning *without* anti-roll guide
- LL09433 160mm blade holder for cryo-sectioning *without* anti-roll guide

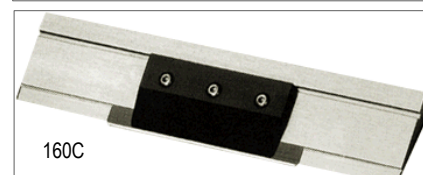
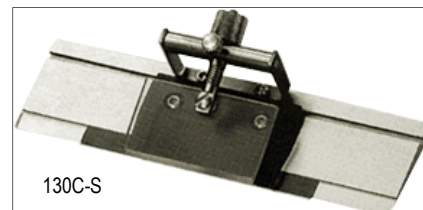

## DDK Tungsten Carbide Knives

These cost effective knives offer outstanding section quality, easily cutting through a variety of densities with consistency and are unconditionally guaranteed. Made from 100% solid high grade tungsten carbide they are recommended for hard tissue, bone or material embedded in MMA, GMA, or frozen material. Available with 35°, 45° or 55° facet angles.

### 16cm Tungsten Carbide Knives for Ambient/Plastic Work

- K115/35** 35° Knife 16cm long DDK *tungsten carbide* profile **C** blade height 3.44cm
- K115/45** 45° Knife 16cm long DDK *tungsten carbide* profile **C** blade height 3.44cm
- K115/55** 55° Knife 16cm long DDK *tungsten carbide* profile **C** blade height 3.44cm
- K116/35** 35° Knife 16cm long DDK *tungsten carbide* profile **D** blade height 3.44cm
- K116/45** 45° Knife 16cm long DDK *tungsten carbide* profile **D** blade height 3.44cm
- K116/55** 55° Knife 16cm long DDK *tungsten carbide* profile **D** blade height 3.44cm

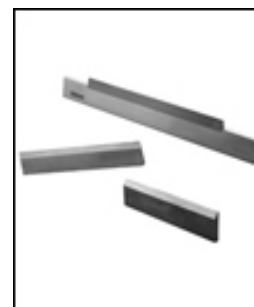

### 16cm Tungsten Carbide Knives for Cryostat Sectioning

This tungsten carbide cutting edge is embedded in a steel holder for improved handling. Available in both C & D profiles.

#### C Profile

- K117/35** 35° 16cm Knife tungsten carbide C profile
- K117/45** 45° 16cm Knife tungsten carbide C profile
- K117/55** 55° 16cm Knife tungsten carbide C profile

#### D Profile

- K118/35** 35° 16cm Knife tungsten carbide D profile
- K118/45** 45° 16cm Knife tungsten carbide D profile
- K118/55** 55° 16cm Knife tungsten carbide C profile

A sharpening service is available - please ask for details

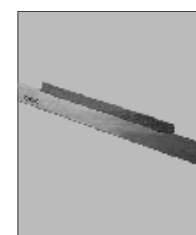

A sharpening service is available for all DDK tungsten carbide knives

## Sectioning Tape Whole Body Autoradiography

- T410** Low temperature sectioning tape type 610 60mm x 50m
- T411** Low temperature sectioning tape type 610 340mm x 25m
- T546** Low temperature sectioning tape type 610 100mm x 50m

The above are *excellent* replacements for the now unavailable 3M 810



# 12 Microtomy and Histology



## Super Cassette Quick Release Chuck C213

Offers the advantage of the standard Quick Release Chuck but takes the larger Super Cassettes for paraffin sectioning. Designed to fit all **sledge** microtomes with minor adjustments, this chuck gives rapid and stable clamping of the cassette along the long axis or across the block with just as rapid removal.



## Cellsafe™ Biopsy Insert

A disposable insert of two hinged interlocking frames with an ultrafine nylon mesh. Fits into any standard cassette. Overall: 28mm x 25mm x 5mm high  
Mesh area 18mm x 18mm x 2mm high

LL30014 Cellsafe™ biopsy insert (100)

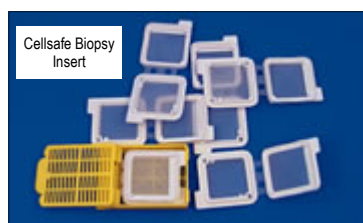

## Large Super Cassettes 75 x 52 x 17mm

These cassettes are 75mm x 52mm x 17mm deep will allow the processing\* and embedding of large sections of brain, breast tissue, prostate, eyes, intact joints, whole animal organs, multiple tissue cases or any specimen larger than normal. Rigidly constructed to support the larger block this cassette is *produced with its own lid*. Super Cassettes are of particular use to research and toxicology laboratories. Available in seven colours. **Super Base Moulds** and the **Super Cassette Chuck** are required for use with this product. Suitable only for **sledge** and **large area** microtomes

Catalogue No.	Description	Quantity
C310/W	Super Cassette <i>White</i>	Case of 100
C310/B	Super Cassette <i>Blue</i>	Case of 100
C310/Y	Super Cassette <i>Yellow</i>	Case of 100
C310/G	Super Cassette <i>Green</i>	Case of 100
C310/P	Super Cassette <i>Pink</i>	Case of 100
C310/O	Super Cassette <i>Orange</i>	Case of 100
C310/GY	Super Cassette <i>Grey</i>	Case of 100
C310/R	Super Cassette <i>Red</i>	Case of 100

## Super Cassette Moulds

Designed for use with Super Cassettes to enable embedding of larger pieces of tissue. Made of stainless steel these reusable base moulds fit the Super Cassette and allow easy block removal after cooling.

C312/10 Super Cassette Mould 66 x 54 x 15 (10)  
C312/2 Super Cassette Mould 66 x 54 x 15 (2)

## Multi-Cassettes with Lids Attached

These processing and embedding cassettes are fitted with a plastic lid attached by a unique hinge enabling quick attachment and removal. They are precision moulded from a solvent and acid resistant plastic, an advantage for decalcification of specimens. The three-sided textured writing surface and flat front provide an advantage when writing and make the cassette particularly suitable for use with cassette printing machines. Moulded with parallel vents for enhanced fluid and wax transfer, this cassette has thickened walls for stability. The "stay-shut" latch closure and rounded thumb tab enables easy lid removal. Readily available in eight colours and with lids attached or packed separately. Size 76 x 52mm. An additional six colours are available on request (minimum quantities apply).

Catalogue No.	Description	Quantity
C309/W	Multi-Cassette <i>White</i>	Case of 100
C309/B	Multi-Cassette <i>Blue</i>	Case of 100
C309/Y	Multi-Cassette <i>Yellow</i>	Case of 100
C309/G	Multi-Cassette <i>Green</i>	Case of 100
C309/P	Multi-Cassette <i>Pink</i>	Case of 100
C309/O	Multi-Cassette <i>Orange</i>	Case of 100
C309/GY	Multi-Cassette <i>Grey</i>	Case of 100
C309/R	Multi-Cassette <i>Red</i>	Case of 100

## Biopsy Cassettes With Lids Attached

Designed for the processing and embedding of most small specimens without the need to use Biopsy Pads or Bio-Wraps®. The rigidly constructed cassette is made from solvent and acid resistant plastic with a three-sided textured writing surface. The 1mm x 1mm square holes permit fluid exchange and thorough wax infiltration. The plastic lid of the cassette also incorporates the "stay-shut" closure design. Readily available in eight colours and with lids attached or packed separately. An additional six colours are available on request (minimum quantities apply).

Catalogue No.	Description	Quantity
C311/W	Biopsy Cassette <i>White</i>	Case of 100
C311/B	Biopsy Cassette <i>Blue</i>	Case of 100
C311/Y	Biopsy Cassette <i>Yellow</i>	Case of 100
C311/G	Biopsy Cassette <i>Green</i>	Case of 100
C311/P	Biopsy Cassette <i>Pink</i>	Case of 100
C311/O	Biopsy Cassette <i>Orange</i>	Case of 100
C311/GY	Biopsy Cassette <i>Grey</i>	Case of 100
C311/R	Biopsy Cassette <i>Red</i>	Case of 100



## Peel-A-Way Moulds

Disposable polyethylene moulds for paraffin or resin embedding designed to easily peel away from the solidified block. All sizes 20mm deep.

**E117** Peel-A-Way mould *rectangular* 25mm x 45mm case of 288  
**E116** Peel-A-Way mould *rectangular* 22mm x 30mm case of 288  
**E115** Peel-A-Way mould *square* 22mm x 22mm case of 288  
**E114** Peel-A-Way mould 22 x 22mm *truncating* to 12mm square 288  
**E113** Peel-A-Way mould 22 x 22mm *truncating* to 8mm square 288

**E117/48** pack of 48  
**E116/48** pack of 48  
**E115/48** pack of 48  
**E114/48** pack of 48  
**E113/48** pack of 48

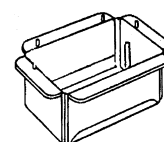

E117

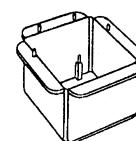

E115

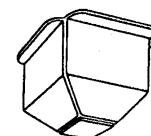

E114

## Pen for Marking Cassettes and Moulds

These Marking Pens are highly resistant to laboratory reagents including alcohol, xylene, xylene substitutes and both water based and alcohol based stains. They have an extra fine point made of rigid nylon which allows for precise marking on glass microscope slides as well as plastic cassettes. The quick drying ink will not run or bleed during routine use. A tight fitting cap helps to prevent the pens from drying out and the thick barrel of the pen and its textured surface provide an excellent grip.

**P361** Cassette Marking Pen box of 12



## Cold Sprays to Assist Sectioning

Frostbite® 12oz can, a CFC free, non flammable but effective rapid cooling agent for paraffin blocks and tissue

**C276** Frostbite® 12oz can

**C276/1** Frostbite® 6 x 12oz cans

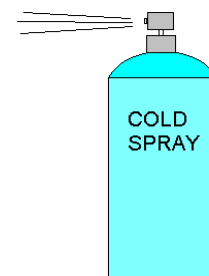

## Frozen Sectioning Embedding Compounds

**C028** Cryo-M-Bed 100ml  
**O023** OCT LT Embedding Compound 125ml

## Immuno Slide Staining Tray



Our immunohistochemistry staining tray is also suitable for routine staining requiring humidity and is ideal for Haematology, Cytology and Microbiology laboratories. It is designed to be semi-disposable. The Immuno Slide Staining Trays are designed for refrigerator to incubator (-20° to +70°C) operation. The standard cover is a black moulded lift-off lid.

The tray is made from black ABS plastic capable of withstanding a wide range of chemicals (avoid chlorinated hydrocarbons). The tray has four rails designed to take up to 20 slides. The rails are topped with a polymer non-slip strip that holds the slides in place without marking them, even when the tray is at an angle. The slides are held at an even height and the interior of the stainer is easily cleaned.

- Black ABS base makes it easier to see specimen on the slide surface.
- Individual wells between rails will hold water securely without splashing.
- Flat Ridges have a black "tacky" surface to minimise slide movement.

It has a sturdy slim line construction and the units are stackable.

Option:

A clear lid allowing visual examination of the slides during staining. Made from PETG with a temperature range of -20°C to +60°C.

**S283** Immuno slide staining tray

## TAAB Bone Saw for Microscopy

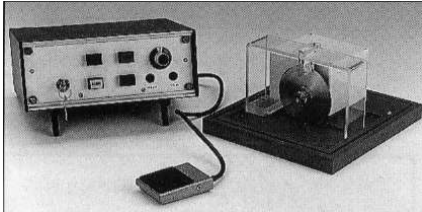

A space saving low speed diamond saw for preparing tough biological specimens including teeth. The control unit can be operated remotely from the cutting head which houses a 4" Ø diamond impregnated cutting wheel (5" instrument available). There is a variable speed control and an immersion lubricating system.

For safety, low voltage circuitry is employed for switching and motor speed control and the whole is encased in a glass reinforced, heat resistant polyester case which is proof against most chemicals, including solvents. Basic unit excludes blades. Ask for quotation.

- M528/B** TAAB bone saw for microscopy 4 inch wheel  
**M528/202** 4" segmented diamond slitting blade  
**M528/203** 4" continuous diamond slitting blade  
**M528/204** 5" continuous diamond slitting blade



G083

## Zerostat 3™ Anti-static Gun

This invaluable tool is ideal for neutralising static electricity in the laboratory. It prevents charged particles from flying during weighing or transfer, keeps film, glass and plastic ware dust and lint free and makes plastic and frozen sectioning more reliable.

**G083** Zerostat 3 anti-static gun

## Water Bath



A paraffin section mounting bath giving comfortable and easy manipulation of sections. The PTFE matt black interior and top allows constant clear visibility. Case constructed from white enamelled aluminium with polypropylene lid. Temperatures from 40° to 60°C.

**W089** Water bath 40° - 60°C 240v 50 Hz



## Mcllwain Tissue Chopper

Designed to prepare tissues for metabolic experiments of small and irregular samples for biopsy or from small organs. For neuroscience it will chop tissues such as hippocampus which is relatively flat and will not suffer excess stress damage. It is also good for preparing cell cultures from the brain of young animals as disturbance to tissue is much less than with a blender or homogeniser. Typical applications are for liver, kidney and parts of the central nervous system. Preparation of 1mm thick slices or cubes and prism samples can be prepared in 30 secs. Section thickness up to 1mm maximum.

Further details on request.

**T537/230** Mcllwain tissue chopper 230v 50Hz  
**T537/110** Mcllwain tissue chopper 110v 60Hz



Rotating chopping table



## Paraffin Wax Dispenser

This wax dispenser provides immediate 'Wax-on-tap' for pathology laboratories. The problem of wax solidifying at the tap is completely eliminated by the incorporation of a thermally insulated tap heater with independent temperature control. The case is constructed of aluminium with an anodised interior and stove enamelled black and white exterior with a black metal lid and polypropylene base. Clear indicating "Power on". Red warning of Over Temperature and amber neons indicating "Bath heater on" and "Tap heater on".

**Capacity** 4. litres (1 gallon Imp.)

**Temperature** Ambient to 75°C. Fitted with safety over-temperature cut-out at 105°C and a non-resettable thermal fuse.

Available in 240V or 110V. Wattage 175 watts (wax heater 150, tap heater 25).

**W085** Paraffin wax dispenser 240V    **W085/1** Paraffin wax dispenser 110V  
**W086** Replacement filter housing    **W087** Replacement tap/heater assy. 240V  
**W087/1** Replacement tap/heater assy. 110V

W085



## Slide Dryer

This slide drying bench speeds the preparation of slides at the mounting stage. It accept up to **50 slides** and has the facility for drying slides according to the preference of the user either by laying across drying bars, angled from the bars or flat without the bars. **Temperature** controllable up to 100°C.

Pilot lights to indicate "Power on" and "Heater on". 150 watts at 230V and 110V

**D128** Slide dryer 230V    **D128/1** Slide dryer 110V  
**D129** Replacement heater 230V    **D129/1** Replacement heater 110V



## Incubators

The Genlab Min Range have temperature control from ambient to 60°C. The outer case has a stoved powder paint finish and there is an aluminium coated mild steel interior with two shelves. Natural convection heating is used, controlled by a direct reading hydraulic thermostat with locking device, supported by an adjustable safety thermostat with indicator. The door has a large window and the controls are at bench level.

**I064** Genlab Min incubator 6 litre capacity 220-240V 50Hz  
 Internal dimensions mm 150H x 230W x 180D External dimensions mm 400H x 330W x 300D

**I061** Genlab Min incubator 18 litre capacity 22-240V 50Hz  
 Internal dimensions mm 260H x 260W x 270D External dimensions mm 510H x 360W x 380D

*Other capacities and temperature ranges quoted on request*



## Filtaire™ Air Purifiers for Laboratories and Offices



Filtaire™ 300

Filtaire™ air purifiers are designed to filter out particles, gases and bacteria down to 0.5µm (Filtaire 200 & 300, Filtaire 5000 down to 0.01µm). They work on a double filtration system, the first in the form of a long lasting spinning disc which collects particles down to sub-micron size, the second being a static filter where the air is projected through it at an acute angle. This enhances its effectiveness at capturing airborne bacteria as well as absorbing gases and odours.

The combination of particle, gas and bacteria entrapment ensures that wherever sited, the Filtaire™ purifier is able to provide a healthier atmosphere in which to work. In addition, there is no 'masking agent' involved and therefore no introduction of further possible pollutants. Maintenance is minimal involving only washing of spinning filters and replacement of static filters dependent on level of air pollution. There are three models available depending on the size of the area to be filtered:

**F220 Filtaire™ 300** ideal for individual offices, rooms, or small laboratories. Bench standing so can be placed close to the source of pollution, or more than one can be located in close proximity to the pollution source.



The Filtaire 5000 can be either wall or ceiling mounted and is supplied complete with a simple to use five speed control unit

Filtaire™ 5000

### Filtaire 5000

A revolutionary new quiet, highly efficient recirculating air purifying system that removes all particulates down to 0.01µm. The ultimate clean air filter removing everything from tobacco smoke to micro-organisms and viruses. The Filtaire™ 5000 system has the ability to focus units close to the source of pollution without extracting air from the environment. This makes it more effective than other forms of air filtering/conditioning systems as the treated air does not have to be reheated in cold weather. Filter changes are fast and simple and units can be bench, ceiling or wall mounted. A single machine will typically clean a room volume up to 150<sup>3</sup>m but larger areas can be covered with multiple units. Filter combinations available for the removal of formalin, glutaraldehyde, toluene, xylene and other life science laboratory chemical vapours. Colour white, but bespoke colours at extra cost with minimum order requirements.

*Dimensions: 200 Depth x 500mm Diameter Weight: 11Kg Power: 230v 130w, 0.6 amps*

Detailed literature available - please ask

**F222 Filtaire™ 5000** high efficiency air filtering system 230v 50Hz

## Section Mounting Press

A metal press for pressing methacrylate sections flat on the slide during the drying procedure.

**T550** Section Mounting Press

### Cover Films

Polyethylene films for covering the methacrylate sections on the slide after spreading (e.g. Technovit 9100 NEW), 25 x 75 mm

**T551** Polyethylene cover films for mounting press 25 x 75mm



## Section Razor S/S

A high quality cut-throat razor with stainless steel blade set in a black plastic handle suitable for use in hand sectioning or clamped in simple microtomes.

**B254** Section razor with S/S blade each

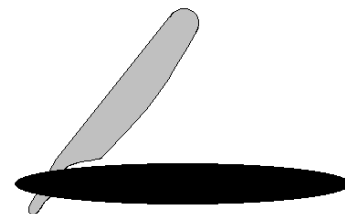

B254

## Palette Knives

Stainless steel, parallel sided blade set in balanced wooden handle. Supplied each

**K079/100** 100mm blade    **K079/150** 150mm blade    **K079/200** 200mm blade

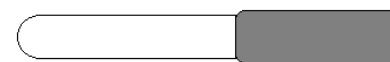

K079

## Section Lifter

**K079** Stainless steel with blade length of 55mm each



## Clean Area Work Trays and Spillage Containers

**Anti-static** spill or work containing trays offering a practical and cost effective solution to managing work areas. These lightweight trays will clearly define your work area without the need for additional bench coverings. Simply rinse away any liquids, wipe the tray dry and you are ready for the next task.

- Made from anti-static, high impact polystyrene
- Sufficient depth to safely contain the largest liquid spills
- Wipe clean and use time and time again

**T451** Spill tray 475 x 360mm    Pk 25    **T452** Spill tray 700 x 450mm    pk 25

**Rigid PVC Spill Trays and Liners** with sufficient depth to prevent dispersal of hazardous liquids. Two colour options - yellow for radiation areas and white for non-radiation areas.

**Colourless PVC Liners** available separately if desired.

**T453** PVC spill tray white 475x360mm (1)    **T456** PVC spill tray yellow 475 x 360mm (1)  
**T454** PVC spill tray white 700x450mm (1)    **T457** PVC spill tray yellow 700 x 450mm (1)  
**T455** Colourless PVC liner 475x360mm (10)    **T458** Colourless PVC liner 700 x 450mm (10)

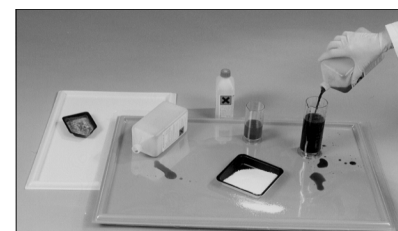
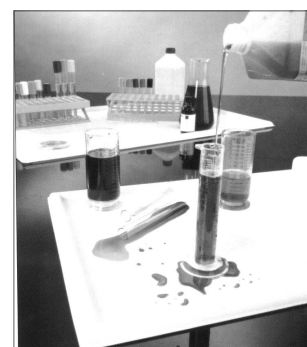

## Dissecting Board

A polypropylene dissecting board 300mm x 210mm

**D130** Dissecting board each



## De-Formalizer™ Pads for cut-up boards

These pads are made with a patented fibre that absorbs and retains aldehyde fluids. On the cut-up board any excess formalin that runs from the tissue will be immediately absorbed and the odour neutralised by a bonded chemical. The Pads are durable, resist tearing even when wet and the blue surface provides an excellent contrast to pieces of tissue.

The Pads are also useful for soaking up leakage and deodorising vapours in other applications. They can be used to line shelves which hold specimen containers which may seep formaldehyde around the lid, or to line transport boxes where leaks may occur.

**D188** De-Formalizer™ Pads 8" x 10" (20.3 x 25.4cm) case of 25





S260

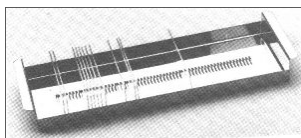

S259

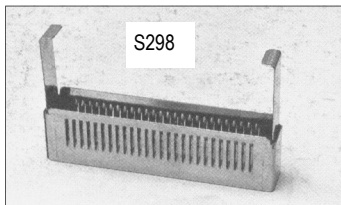
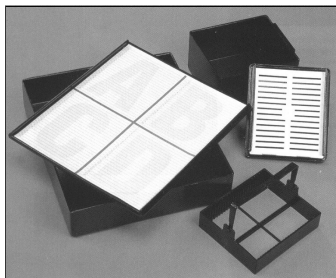
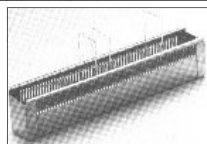

J051



J052



J054

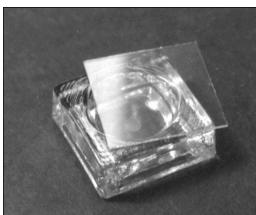
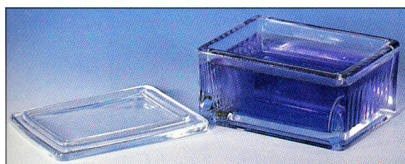

## Slide Staining Racks

**S260 Stainless steel** staining rack carries 60 slides horizontally

**S259 Stainless steel** staining rack carries 60 slides vertically

**Plastic (Polyacetal) Staining Rack** (resistant to xylene and alcohol)

The rack carries 25 slides 76 x 26mm horizontally and is fitted with a swing handle. The trough is fitted with a light-proof lid and can be used for staining, storage and carriage. A polystyrene storage box accommodating four of the staining racks is available.

**S275** Plastic staining rack each

**S276** Staining Trough each

**S277** Storage box for 4 staining racks each

## Coverslip Staining Racks

Stainless steel racks with grooves to hold either 25 or 6 coverslips vertically. Please add suffix **/S** for rack to hold 6 coverslips.

**S298** Staining rack for 12mm coverslips

**S391** Staining rack for 13mm coverslips

**S392** Staining rack for 18mm coverslips

**S393** Staining rack for 24mm coverslips

**S394** Staining rack for 26mm coverslips

**S395** Staining rack for 30mm coverslips

## Coplin Staining Jars

### Glass

A heavy duty staining jar with a drop-on glass lid for slide staining or use as a solvent chamber. Holds **5** single 76 x 26mm slides vertically or **10** slides back-to-back. Volume approx. 30ml.

**J051** Coplin staining jar glass pack of 10    **J051/1** Coplin jar glass each

### Polythene

A tough moulded Polythene staining jar with a screw-on lid with the same capacities as J051. It can also be useful for slide transit

**J052** Coplin staining jar Polythene each    **J052/1** Coplin jar Polythene pack of 10

## Hellendahl-Vertical Staining Jar

An **all glass** rectangular staining jar which accommodates 16 slides 76 x 26mm vertically back-to-back and comes with a drop-on glass lid. The wide top eliminates the need to handle the slides with forceps. Volume 80ml.

**J054** Hellendahl jar each

**J054/1** Hellendahl jar pack of 10

## Schieferdecker-Horizontal Staining Jar

An **all glass** rectangular staining jar with drop-on glass lid to accept 10 76 x 26mm microscope slides horizontally, volume 100ml

**J053** Schieferdecker jar each

**J053/1** Schieferdecker jar pack of 10

## Glass Staining Block

A solid glass block with polished 6mm deep semi-circular cavity and flat glass cover. Useful for viewing or staining free-floating specimens.

**S166** Staining block 40mm x 40mm each



## Glass Staining Trough and Slide Carrier

Glass staining trough 83mm x 103mm x 70mm high with smooth sides and drop-on glass lid. Accepts one glass slide carrier holding 20 slides 76 x 26mm back-to-back

- S337 Staining trough each  
S338 Glass slide carrier each



## Staining Bath and Racks for 50 Slides

A glass staining bath with the capacity to take 50 glass microscope slides in 10 slide holders each holder carrying 5 slides. The slides can remain in the holder even during microscopic examination if required.

- S404 Staining bath and slide holders for 50 slides



## Columbria Jar for Coverslip Staining

Glass staining jar with grooves to take 22mm square coverslips vertically, 4 individually or 8 back to back. Black plastic lid with foil lined cork backing. Low volume (8ml) makes it ideal for use with costly reagents.

- J055 Columbria coverglass staining jar J055/1 Columbria jar pack of 10

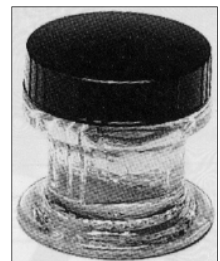

## Pyrex Glass Dish

A clear, circular, flat bottom dish without spout, 140mm Ø and 75mm deep with a volume of 900ml.

- B244 Circular Pyrex dish each



## Dropper Bottles

A clear glass drop bottle with plastic stopper and glass rod dropper. Ideal for dispensing immersion oil.

- B174 Dropper bottle with glass rod 60ml each

### T.K. Drop Bottle

Dark glass bottle with ground in grooved glass stopper for dispensing small amounts of liquid.

- B175 TK Drop bottle 50ml each



B174

B175

## Spirit Levels

**Bulls Eye Level** with single vial which operates in all horizontal planes. Ideal for permanent or temporary attachment to laboratory equipment.

- L146 Bulls eye spirit level 25mm Ø

**General purpose Pocket Level** made from satin finish aluminium hexagonal bar with dome end stops.

- L147 General purpose pocket level 67mm

- L148 General purpose pocket level 96mm



L146

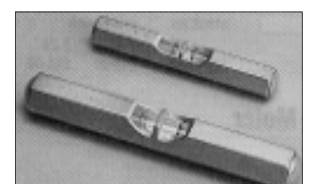

L147/8

Please ask for a copy of our free publication 'The Care and Use of Diamond Knives'.

'Old' knives of a different make can often be used to buy diamond knives at a discount - please ask

## TAAB Diamond Knife Wetting Agent

Most new diamond knives are hydrophilic and should not present problems with edge wetting. However have you got an older knife that causes problems or is the exception to the rule? Then our wetting agent either full strength or diluted should solve your problem for several weeks before re-treatment is needed.

W101 Diamond knife wetting



Standard 35°/45°



Cryo 35°/45°

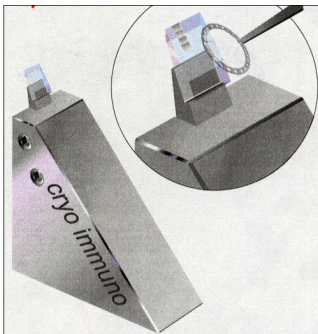

Cryo immune knife



Ultrasonic knife with controller

## Diamond Knives

We are able to offer a choice of the market leading brands of diamond knives for ultrathin and semithin sectioning. All knives are guaranteed and details of their care and use are available in data sheet form from TAAB free of charge.

Diamond knives are not only for those people with tough specimens where they produce results unobtainable with glass knives, but also for the hard pressed modern laboratory where time is of the essence and results are required without time-loss. Diamond knives have the ability to cut all manner of soft and hard specimens and section samples with mixed densities within the same block. They have a remarkable tolerance for producing results from difficult specimens that makes them an invaluable tool for any modern electron microscope laboratory.

The cost of the diamond knives is more than compensated for by the speed of production of useable results from imperfect embeddings or from samples unavoidably accepted from third parties where preparation quality is unknown. Diamond knives supplied by TAAB can be resharpened an infinite number of times at a price a little over half that of a new knife.

## Diatome Diamond Knives for EM

Swiss diamond knives with an enviable reputation for reliability and performance.

### Diatome knives for ultrathin ambient sectioning

#### Standard ambient knives

The standard holder is blue anodised with the diamond is ground to a 45° angle. **We now recommend 35° as a no-cost option for all standard work being the best compromise between performance and edge life.** We can offer black anodised boats for those who prefer them. The choice of holder does not affect the purchase price. The edge lengths available are as follows:

**K065/15** 1.5mm, **K065/20** 2.0mm, **K065/25** 2.5mm, **K065/30** 3.0mm, **K065/35** 3.5mm  
**K065/40** 4.0mm

### Diatome Cryo Knives

#### Standard cryo knives

Holders for cryosectioning are normally triangular (without flotation bath) and manufactured from a special alloy. They can be specified with a flotation bath and 35° or 45° angles at no extra cost. Knife sizes available:

**K065/C/15** 1.5mm, **K065/C/20** 2.0mm, **K065/C/25** 2.5mm, **K065/C/30** 3.0mm, **K065/C/35** 3.5mm and **K065/C/40** 4.0mm

#### Cryo immune knife for sucrose droplet and frozen hydrated sections

The cryo immune knife has a 35° or 25° diamond for lowest section compression and is the first cryo diamond knife with a plateau. The 35° gives optimised section pick-up resulting in the best section quality for immunocytochemistry using a loop and sucrose/methyl cellulose droplet. This method reduces the stress applied to the section and leads to better structural preservation. The 25° knife is designed for frozen hydrated specimens. Both are available only with 3mm edge.

**K065/30/C/35** 3mm Diatome Cryo immune diamond knife 35° for sucrose  
**K065/30/C/25** 3mm Diatome cryo immune 25° for frozen hydrated

**Please ask about cryo 25° knife for frozen hydrated sections**

### Diatome Ultrasonic Knife

A totally new concept in ultrathin sectioning giving practically zero compression, thinner sections, better structural preservation and easier sectioning of 'difficult' materials. The oscillations are strictly controlled in the horizontal plane. The results at room temperature are exciting but at low temperature are exceptional.

**K067/30** 3.0mm Diatome Ultrasonic oscillating diamond knife with controller

## Diatome Cryo Trimming Knives

For successful ultramicrotomy precise trimming of the specimen is essential. The extreme sharpness of the Diatome trimming blades ensures accurate trimming with minimum mechanical damage resulting shiny surfaces that make alignment easier and safer. All three versions can be fitted into Leica or RMC cryo ultramicrotomes:

### Cryotrim 20 and 45

The Cryotrim 45 produces pyramidal sides with an inclined angle of 45° and the Cryotrim 20 produces 20° sides. Both are ideal for:

- sucrose protected biological samples
- frozen hydrated samples
- polymers

**K094/45** Cryotrim 45

**K094/20** Cryotrim 20

For all trimming and sectioning we recommend the use of the Static Line II Deioniser (see page 21)

### Ultratrim

Produces 90° square sides and although useful for cryo sectioning is more suitable for:

- epoxy and acrylic embeddings
- polymers
- non ferrous metals

**K094** Ultratrim trimming diamond 3mm

**K094/4** Ultratrim trimming diamond 4mm

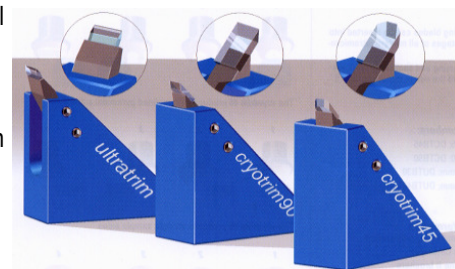

K094



## Knife Cleaning Sticks

Ideal materials for cleaning diamond knives. Bevel one end to a 60° "V" with a degreased razor blade. Dip in ethanol 100% ethanol (50% for biological samples) and shake off the excess. Gently run the rod across the cutting edge without applying lateral pressure.

**C097** Pithwood bundle of 10 pieces

**C259** Polystyrene cleaning stick pack of 5

## Diatome Diamond Knives for Light Microscopy

### Histoknives for Light, Semithin and Materials Microscopy

Polished to a degree which provides excellent results for ultrathin materials sectioning, these knives are resilient enough to produce first class sections over a long period of time in the micron range for light microscopy. Available in the following sizes:

**K090/40** 4.0mm, **K090/50** 5.0mm, **K090/60** 6.0mm, **K090/80** 8.0mm **K090/100** 10.0mm

### Histo Jumbo

A 6mm Histoknife with a water bath large enough to accept 3" x 1" microscope slide.

**K090/60/J** 6mm Diatome Histoknife with jumbo water bath

### Diatome Cryohistoknife

A triangular knife with holder of special alloy suitable for low temperature cryostat sectioning in life science and materials applications.

**K090/4/C** Diatome 4mm Cryo Histoknife



Histo

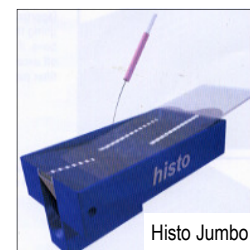

Histo Jumbo



## Diatome Knives for AFM

The high quality Diatome diamond knives are not just perfect for producing ultrathin and semi-thin sections, but also for surfacing sectioning of all kinds of biological and industrial specimens for AFM investigation. Instead of a section as for TEM, the specimen surface is investigated using AFM. In order to achieve the best results for AFM investigation, only the highest quality diamond knives should be used.

Diatome ultra AFM and cryo AFM knives are specially tested to ensure that they meet the increased quality requirements of AFM investigation. They produce extremely smooth sample surfaces and guarantee the best possible structural preservation. They are produced with a 35° angle.

**K092/20** Diatome Ultra AFM 2mm

**K093/20** Diatome Cryo AFM 2mm

**K092/30**

Diatome Ultra AFM 3mm

**K093/30**

Diatome Cryo AFM 3mm

Morphology of a blend of two SBS block copolymers with different chain-architecture. AFM tapping mode, phase image.

Rameshwar Adhikari, Institut für Werkstoffwissenschaft, Martin-Luther-Universität, Halle-Wittenberg.

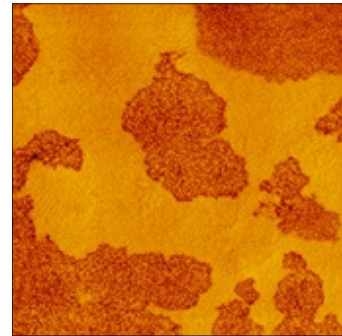

## Diamond Knife for Gatan 3View®

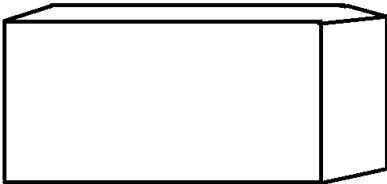

Diatome diamond knife for fitting to Gatan 3View® ultramicrotome system for serial blockface SEM 3D reconstruction. Consists of the complete diamond shank ready to fit to the 3View® system by the customer. Alternatively the complete holder can be returned for factory fitting at no extra cost other than postage. A sharpening service is also available.

**K121** Diatome diamond knife for Gatan 3View® 3D reconstruction system

## Diamond Knife Cleaner



This instrument has been specially designed for cleaning diamond knives. The diamond knife (any make with a 9.5mm base) is held in a special holder which fits into a 100ml beaker mounted on top of a magnetic stirrer turning at approximately 1800 rpm. Direction is reversed twice every minute. The cleaning liquid can be distilled water or one of the mild surfactants recommended in our "Care and use of diamond knives" data sheet. The six position timer can be set from 15 minutes to eight hours. Dimensions 4¾" x 3" x 2½" high (with beaker in place 5½")

**C205/1** Diamond knife cleaner 240V

**C205** Diamond knife cleaner 120V

## Diamond Knife Cleaning Kit

A kit for cleaning the edge of diamond knives consisting of Tween 80 solution (100mls), dropper bottle, polystyrene sticks, single bristle brush and cleaning instructions.

**C262** Diamond knife cleaning kit

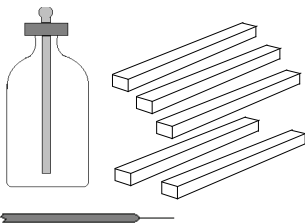



## Microstar Diamond Knives

American knives with a huge range of holders. Each knife has a 12 month warranty against any defects. The following types of knife are available:

**SU** Standard Ultramicrotomy      **CW** Cryo Wet      **CD** Cryo Dry

**MT** Materials Science      **LH** Light Microscopy      **LC** Light Microscopy Cryo

There are eight different boat styles but we supply standard black anodised holder type SU with oval cavity unless otherwise instructed, or for cryo, triangular stainless steel with non-glare finish. Normal knife angle is 45° but 35° and 55° are no-cost options for some applications.

**Microstar ultrathin knives Types SU, CD, CW**, in sizes:

<b>K080/10</b> 1.0mm	<b>K080/12</b> 1.2mm	<b>K080/14</b> 1.4mm	<b>K080/15</b> 1.5mm
<b>K080/16</b> 1.6mm	<b>K080/18</b> 1.8mm	<b>K080/20</b> 2.0mm	<b>K080/22</b> 2.2mm
<b>K080/24</b> 2.4mm	<b>K080/25</b> 2.5mm	<b>K080/26</b> 2.6mm	<b>K080/28</b> 2.8mm
<b>K080/30</b> 3.0mm	<b>K080/32</b> 3.2mm	<b>K080/34</b> 3.4mm	<b>K080/35</b> 3.5mm
<b>K080/36</b> 3.6mm	<b>K080/38</b> 3.8mm	<b>K080/40</b> 4.0mm	<b>K080/42</b> 4.2mm
<b>K080/44</b> 4.4mm	<b>K080/45</b> 4.5mm	<b>K080/46</b> 4.6mm	<b>K080/48</b> 4.8mm
<b>K080/50</b> 5.0mm	<b>K080/52</b> 5.2mm	<b>K080/54</b> 5.4mm	<b>K080/55</b> 5.5mm
<b>K080/56</b> 5.6mm	<b>K080/58</b> 5.8mm	<b>K080/60</b> 6.0mm	

**Microstar ultrathin knives type MT** (Materials Science)

Ultramicrotomy knives suitable for difficult materials samples and not polished to the same degree as **SU** knives. Available in the following sizes:

<b>K081/20</b> 2.0mm	<b>K081/25</b> 2.5mm	<b>K081/30</b> 3.0mm	<b>K081/35</b> 3.5mm
<b>K081/40</b> 4.0mm	<b>K081/45</b> 4.5mm	<b>K081/50</b> 5.0mm	<b>K081/55</b> 5.5mm
<b>K081/60</b> 6.0mm	<b>K081/65</b> 6.5mm	<b>K081/70</b> 7.0mm	

**Microstar light microscope knives types LH**

Knives suitable for thicker sections (>1µm) on ultramicrotomes or special motorised rotaries. Available in the following sizes:

<b>K082/40</b> 4.0mm	<b>K082/45</b> 4.5mm	<b>K082/50</b> 5.0mm	<b>K082/55</b> 5.5mm
<b>K082/60</b> 6.0mm	<b>K082/65</b> 6.5mm	<b>K082/70</b> 7.0mm	<b>K082/75</b> 7.5mm
<b>K082/80</b> 8.0mm	<b>K082/85</b> 8.5mm	<b>K082/90</b> 9.0mm	<b>K082/95</b> 9.5mm
<b>K082/100</b> 10.0mm			

**Microstar light microscope knives types LC**

Knives suitable for cryostat sectioning (>1µm) or low temperature materials EM. Available in the following sizes:

<b>K083/40</b> 4.0mm	<b>K083/45</b> 4.5mm	<b>K083/50</b> 5.0mm	<b>K083/55</b> 5.5mm
<b>K083/60</b> 6.0mm	<b>K083/65</b> 6.5mm	<b>K083/70</b> 7.0mm	<b>K083/75</b> 7.5mm
<b>K083/80</b> 8.0mm	<b>K083/85</b> 8.5mm	<b>K083/90</b> 9.0mm	<b>K083/95</b> 9.5mm
<b>K083/100</b> 10.0mm			

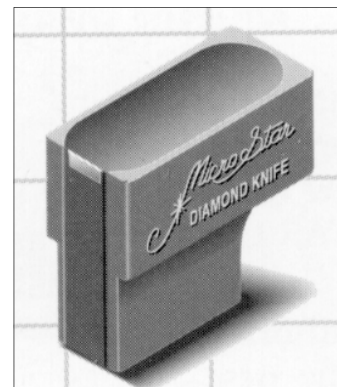

Microstar type SU



Microstar type CD

Standard boat and holder

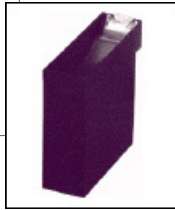

Old style boat and holder



Dry Cryo Knife



Wet Cryo Knife

**Please ask about:**

Trade-in Prices

Exchanges

Upgrades

## DDK Diamond Knives (Delaware Diamond Knives Inc)

DDK have a long history with electron microscopy and the roots go back to the DuPont knives of the 1960's. DDK was formed in March 1986 when the DuPont diamond knife business was purchased by the manager of the DuPont EM business and operated as DDK. The Company has a vast knowledge of the applications of their products.

All knives are made from gem quality diamonds and the holder is anodised aluminium or stainless steel (cryo). The epoxy sealing the diamond into the boat is impervious to all solvents and is hydrophilic so that edge wetting is not a problem. The clearance angle is factory set for 4°.

The standard included knife angle is 45° but other angles such as 55° or 35° are available on request as a no cost option. Custom knives and angles can also be specified.

All knives may be resharpened an infinite number of times.

**The quality of new and resharpened knives is second to none**

## DDK Knives for Ultramicrotomy

We will normally supply a 45° diamond blade sealed in the standard, black anodised holder with a large oval reservoir which will fit all standard ultramicrotomes. Please contact us if you require other included angles. The old boat style is still available. Please indicate this on your order should you prefer it.

### Edge Lengths mm

K113/10	1.0-1.4	K113/15	1.5-1.9	K113/20	2.0-2.4	K113/25	2.5-2.9
K113/30	3.0-3.4	K113/35	3.3-3.9	K0113/40	4.0-4.4	K113/45	4.5-4.9
K113/50	5.0-5.4	K113/55	5.5-5.9				

**Cryo knives** are available in the same sizes with holders in *stainless steel*. For Dry Cryo Knives please add the suffix */C* and for cryo knives with boats please add the suffix */CW*

Example: the **Cat. No.** for a 3mm Dry Cryo knife is **K113/30/C**  
for a 3mm Wet Cryo knife is **K113/30/CW**

## DDK "Histoknives" for Histology

The DDK diamond histo knives are made from natural diamond and will cut thin sections of plastic embedded tissue/material. Suitable for Biological or Materials work they are a cost-effective solution for cutting semi-thin or hard materials. As with the Ultra knives they may be resharpened an infinite number of times.

### Edge Lengths in mm

K114/20	2.0-2.9	K114/30	3.0-3.9	K114/40	4.0-4.9	K114/50	5.0-5.9
---------	---------	---------	---------	---------	---------	---------	---------



## DDK Triangular Tungsten Carbide Knives

A disposable knife made to fit glass knife holders on ultramicrotomes or specialised rotary microtomes for cutting location sections 2—15µm or trimming plastic blocks or hard specimens. Example applications are:

Serial sectioning of the cornea, mouse brains, fish embryos, Spinal cords, Section scanning, Polyester film and hard materials, Trimming / block facing, Ovaries / Fish eggs, Skin biopsies, Bone marrow biopsies and mineralized bone, Lymph nodes, Decalcified bone.

### Specifications:

Cutting edge length	9.6mm (0.38")
Blade height	25.4mm (1")
Cutting angle	40°
Material	100% high grade, solid Tungsten Carbide

**K119** DDK triangular tungsten carbide knife pack of 3

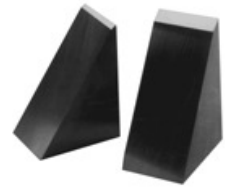

## DDK Disposable Tungsten Carbide Knives

These blades give improved productivity and versatility when sectioning plastic. They feature a low angle (35°) for best quality sections of soft samples. Try them for your toughest cryostat sectioning problems, too! Other applications are:

Fibres in GMA	3µm	Animal tissues in cryostat	3µm
Cartilage in paraffin	5µm	Decalcified bone in paraffin	5µm
Renal biopsies in GMA	1.5µm	Skin in cryostat	7µm
Paint samples in GMA	3µm	Eucalyptus root in GMA	1µm
Neurotox studies in GMA	1µm	Tumours in GMA	2µm

**KXXX** Disposable tungsten carbide blades

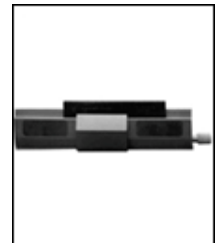

## Sapphire Knife Synthetic Single Crystal Sapphire for Vibrating Microtomes

These cost effective knives offer outstanding section quality, easily cutting through a variety of densities with consistency and are unconditionally guaranteed. With a sapphire knife, thinner sections are possible with [vibrating microtomes](#). Made from synthetic single-crystal sapphire, the more-perfect edge of this knife gives distortion-free sections under 10 microns thick. Makes the vibrating microtome an attractive alternative to the cryostat when you need thin sections of fresh or lightly fixed tissue for fluorescent labelling, autoradiography, immunohistochemistry, etc.

With cleaner sections and smoother surfaces the sapphire knife provides significantly improved section quality over traditional razor blades, particularly in electrophysiology applications. By making a cleaner cut, the surface cells remain alive and intact, so the researcher can more easily explore the live and responsive interior cells. The clean cut produced by the sapphire knife results in vibratomed sections for histology that have smoother surfaces, making it easier to follow small labelled elements.

Avoid the hassles of frequent changing of disposable blades! Take care to avoid contact of the edge with anything other than your sample and your sapphire knife edge will last for thousands of sections. The knife is easily cleaned of glue and tissue and fits tightly in knife holders of most vibrating microtomes.

### Specifications

Height 12mm (0.5") Length 40mm (1½") Width 0.9mm (0.035")

**B581** Sapphire blade (each)



## Glass Knives and Accessories

### Leica EM KMR3 Glass Knifemaker



This new design EM KMR3 glass knifemaker from Leica has simpler operation and more consistent results from all thicknesses of glass than previous models. The knives are triangular after Latta and Hartman. With the breaking mechanism now above the glass, easier manipulation of the glass and a new design scoring wheel and cartridge, the "Balanced Break" technique can be utilised using a slower break providing better knives with less distortion. New adjusters with self-locking screws allow the glass to be positioned so that two knives with similar sized counterpieces can be made. Previously, glass knives would have a final angle of 55-60° but with the EM KMR3 they are much nearer to 45° and much more suitable for cryosectioning.

Glass of thicknesses 6, 6.4, 8 and 10mm can be routinely broken making the knifemaker suitable for ultramicrotomy or histology.

**K111** Leica EM KMR2 glass knifemaker

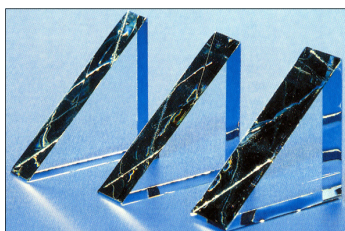

### TAAB Histoknifemaker for "Ralph" Knives

An easy to use knifemaker of substantial construction for the reliable production of Ralph glass knives for use in histology or plastic sectioning.

Preset with simple controls the instrument allows inexperienced operators to quickly produce knives of excellent quality. The standard instrument will produce knives from 25.4mm (1 inch) wide Superglass strips (or any other 6mm thick glass). An instrument for 38mm (1½") glass is available to special order. Both instruments are easily cleaned to maintain years of accurate and safe knife making. Instruments delivered with tools and a pack of appropriate glass.

**K058** TAAB Histoknifemaker for 25.4mm glass  
**K058/W** TAAB Histoknifemaker for 38mm glass

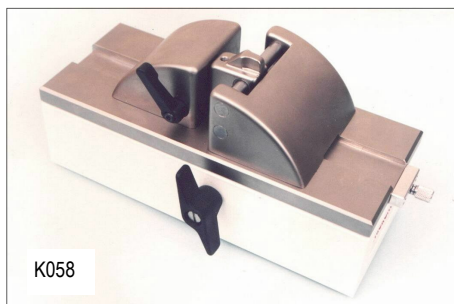

K058

### Knife Holder for "Ralph" Glass Knives

A brass knife holder to take either 25.4mm or 38mm "Ralph" knives which will fit into any standard rotary microtome knife clamp (e.g. knife holder 'N' from Leica or Microm). The angle brackets locate the knife firmly with Allen screws (key supplied) and the clearance angle can be altered in the normal way. Length 17cm, width 6mm (with clamps 16mm).

**K058/25** Histoknife holder for 25.4mm (1 inch) "Ralph" knife



### Glass Breaking Pliers

**G103** Very strong to give life-long trouble free use. They have alignment marks for accurate positioning on the glass

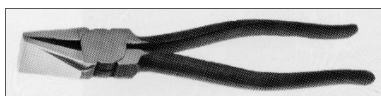

### Manual Glass Scorer

**G051** High quality tungsten cutting wheel with shaped handle for comfort and control





## Knifemaker Glass for Electron and Light Microscopy

TAAB Superglass is specially selected high quality glass precision cut for reproducible results. Glass ages quickly after scoring so it is always best to score and break immediately and not store previously scored glass strips. We recommend all glass is washed with a dilute detergent in water before use and dried using non fibrous cloth or tissue.

### Glass for TAAB and older Sorvall/RMC Knifemakers

- G065** TAAB Superglass 8" x 2" x 6mm pack of 50 sheets
- G066** TAAB Superglass 8" x 2" x 10mm pack of 30 sheets
- G070** TAAB Superglass 8" x 2" x 12mm pack of 25 sheets

### Glass for LKB/Reichert/Leica and newer RMC Knifemakers

- G067** TAAB Superglass 16" x 1" x 6mm pack of 30 strips
- G067/1**TAAB Superglass 16" x 1" x 6mm pack of 10 strips
- G067/T**TAAB Superglass 16" x 1" x 6.4mm pack of 30 strips
- G137** LKB/Leica ultramicrotome glass 16" x 1" x 6.4mm pack of 30
- G105** TAAB Superglass 16" x 1" x 8mm pack of 24 strips
- G159** TAAB Superglass 16" x 1" x 10mm pack of 15
- G154** TAAB Superglass 8" x 1" x 6mm pack of 32 \*
- G106** TAAB Superglass 8" x 1" x 8mm pack of 28 strips \*
- G068** TAAB Superglass 8" x 1" x 10mm pack of 20 strips \*
- G081** TAAB Superglass 16" x 1½" x 6mm pack of 20 strips

\* Can also be used on TAAB Glass Knifemaker Mk2

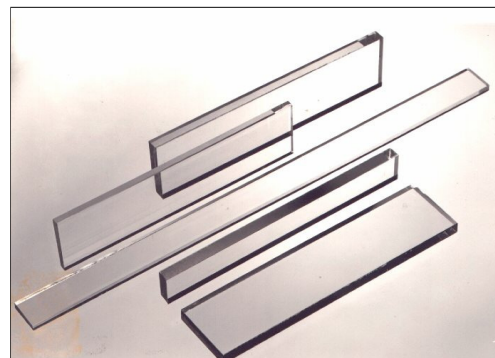

### Histological Grade

- G084** TAAB Superglass 16" x 1½"(38mm) x 6mm pack of 20 strips
- G085** TAAB Superglass 16" x 1"(25.4mm) x 6mm pack of 30 strips

## Boat Making Materials

- T066** **Silver Tape** roll 9mm wide x 66m long for making boats (non conducting)
- T402** **Silver Tape** roll 12mm wide x 66m long for boats
- T065** **Heavy duty tape dispenser** for reels with internal dimension of 75mm
- T366** **SLEEK Tape.** Self sealing tape one inch wide for making boats without wax. Easy-to-follow guide available on request
- W050** Dental wax pink, toughened, 1 box. Each box contains 1lb (454g), 22 sheets

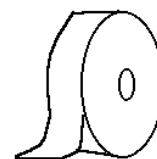

## LKB/Leica Preformed Trufs

Moulded disposable black plastic troughs that speed up and simplify the preparation of glass knives for ultramicrotomy without the use of tape. The uniform shape gives reproducible lighting parameters and water levels. They are easily sealed to the glass knife with molten wax using the LKB/Leica Multiplate and the large water bath allows large area sectioning or long ribbons to be produced.

- T336** Trufs for boats 6.4mm wide sealed pack of 50
- T341** Trufs for boats 6.4mm wide sealed pack of 500
- T445** Trufs for boats 8mm wide sealed pack of 500 pieces
- T446** Trufs for boats 8mm wide sealed pack of 50 pieces
- T447** Trufs for boats 10mm wide sealed pack of 500 pieces
- T448** Trufs for boats 10mm wide sealed pack of 50 pieces



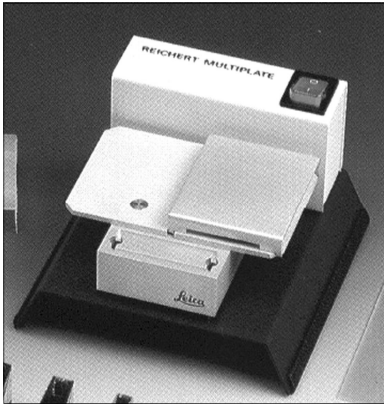

## LKB/Leica Multiplate

A compact ultramicrotomy hotplate with three decks at 95°C, 80°C, and 60°C.

### Attaching Trufs

The wax melting deck is at 95°C to provide wax for attaching Trufs. By placing Trufs on this deck the wax is distributed evenly on the edges so they attach easily and securely to the knives.

### Drying and heating

The drying deck has a temperature of 80°C, ideal for drying and attaching semi-thin sections to slides. The deck is large enough to dry 6 slides at a time. By mounting a raised plate over half of the drying deck a heating deck of 60°C is produced for staining sections.

**H065** Multiplate 220/240V 50 Hz

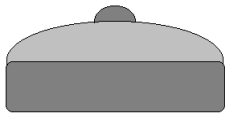

K063/64

## Glass Knife Storage Boxes

TAAB have available two economically priced storage boxes for 6mm or 10mm and 12mm triangular glass knives. The 6mm storage box with accommodate 10 knives and the 10/12 box 6 knives in a secure and clean environment. The knives are held in slots formed in a silicon rubber insert and protected by a removable plastic dust cover. Ideal for transit around the laboratory.

**K063** Knife storage box 6mm

**K064** Knife storage box 10/12mm

K107

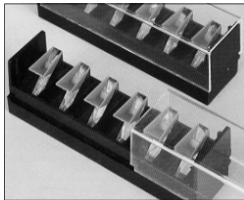

The Leica knife box has a clear sliding lid and can hold up to six 6mm knives with or without Trufs.

**K107** Leica knife storage box (3 pieces)

## Ultramicrotomy Heat Pen



P184

A controlled, safe and efficient way of reducing compression in plastic sections. Eliminates the disadvantages of vapour methods which subject the operator to a health hazard. Provides an easily controllable amount of heat just above the floating sections. Potentiometer control for adjustment of output voltage and LED auto zero current meter.

### Specification

220V 50Hz or 120V 60Hz

Dimensions: 65 x 130 x 114mm Power cable 1.8m Penholder cable 1.5m

Weight approx. 480gms

**P184** Heat pen 220V

**PP184/1** Heat pen 120V

**P184/F** Replacement filament

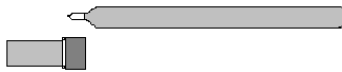

P273

## Disposable Heat Pen

Low priced disposable units using alkaline batteries as the power source. Compact and portable, 20cm long with protective cap. Safer and more controllable than organic vapours for expanding sections in the ultramicrotome water bath.

**P273** Disposable heat pen

## Absorbent Paper Points

Machine rolled paper with a tapered end which offers good water absorbency and assists in the accurate removal of surplus water from the knife boat, the block face, between the tines of tweezers or from grids. No random fibres to obstruct or damage the specimen.

Available in several sizes:

**P400** 200 assorted point sizes 15, 20, 25, 30, 35 and 40

**P401** 200 assorted point sizes 45, 50, 55, 60, 70 and 80

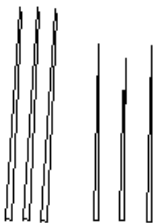

Also available in individual sizes. Point size increases as the number increases.

## Section Perfect Loop for light and electron microscopy

The Perfect Loop allows consistent section pick-up. The outside diameter is the same as the grid and the thickness about 40µm. As the grid and loop are the same diameter they attract one another without section stress or creasing and the section remains in place on the grid without fail.

L138 Perfect Loop EM set L141 3mm loop only L141/5 3mm loop (set of 5) L142 Handle only

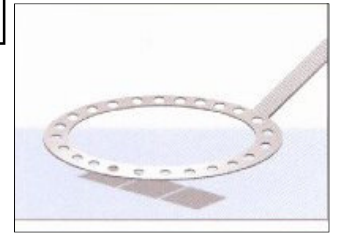

## Section Pick-Up Loop

For those people requiring a ready-made EM loop. Made from nichrome wire and fitted into a black anodised aluminium handle, it is ideal for transferring sections from water surfaces to a specimen grid or microscope slide. Also useful for replica and freeze fracture work. Available with stand.

L089 Section pick-up loop L090/S Stand L090 Section pick-up loop with stand

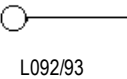
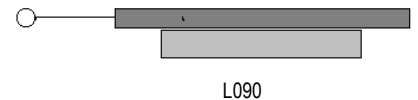

## Wire Loops (to Fit Wire Holder W080)

L092 Nichrome wire loop pack of 3

L093 Platinum wire loop pack of 3

## Wire Holder

Nickel plated brass fitted with screw chuck. Suitable for wire or needles up to 0.56mm (24SWG)

W080 Wire holder 150mm long

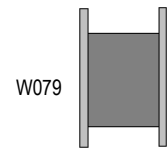
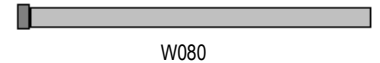

## Nickel/Chrome Wire 80%/20% 'Nichrome'

For making nichrome section loops by hand, 0.25mm Ø (30SWG)

W079 Nichrome wire 10m

## Razor Blades

**Standard** single edged, rigid backed blades ideal for sectioning, trimming etc. Packed in boxes of 100 blades

B054 Blades grade 2 carbon steel box of 100

B301 Blades grade 2 carbon steel **Teflon coated** box of 100

B055 Blades grade 2 carbon steel 10 x 100

B056 Blades grade 1 *stainless steel* box of 100

**Heavy Duty.** For those wishing for a stronger, more rigid blade. Similar to B054 but without the end notches. Added strength with a superior cutting edge.

B146 Blades grade 2 heavy duty carbon steel box of 100

### Holder for Single Edge Blades

This holder will accept any of the B054, B055 or B056 blades. The blade holder offers a much safer method of use of single edge blades, keeping the fingers further away from the cutting edge when cutting hard materials. The blade is retracted when not in use. It is easy to reverse the blade to reveal a new cutting edge or to refill with a new blade. Comes complete with one blade.

B181 Holder for single edge blade

**GEM Blades in Dispenser.** Acclaimed as the first quality carbon steel blade 0.009" thick. The GEM blades from the USA come in a safety dispenser containing 10 blades and used blades are stored in the base of the dispenser for safe disposal.

B147 GEM blades 10 in dispenser

B147/1 GEM blades pack of 12 dispensers

See more Razor Blades also on page

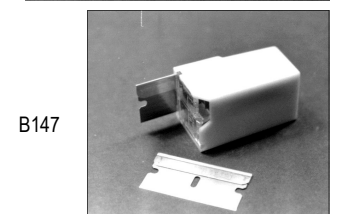
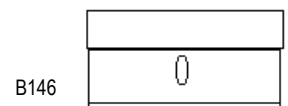
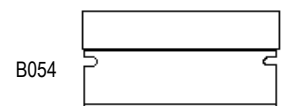

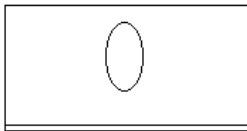

B335

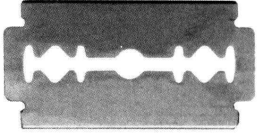

B253

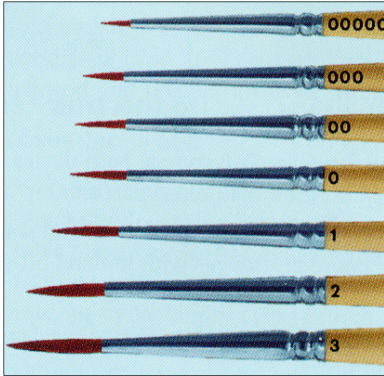

B246

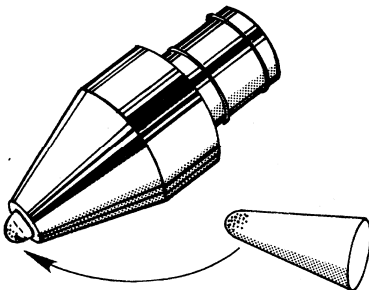
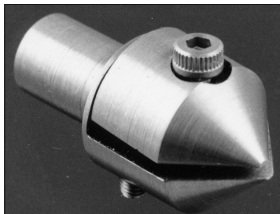

## Blades Unbacked

**B335** Blades unbacked rigid carbon steel box of 100

## Blades Double Edge

**B253** Double edge stainless steel 0.004" thick box of 10

**B253/1** Double edge stainless steel 0.004" thick box of 10 x 10

## Sable and Squirrel Hair Brushes

A range of high quality brushes for handling and manoeuvring delicate sections.

### Sable Hair

**B187** Brush size 3 pack of 5

**B191** Brush size 00 pack of 5

**B188** Brush size 2 pack of 5

**B192** Brush size 000 pack of 5

**B189** Brush size 1 pack of 5

**B193** Brushes one of each size (6)

**B190** Brush size 0 pack of 5

**Squirrel Hair** an economical alternative to sable for many applications

**B194** Brush size 0 pack of 5

**B126** Brush size 3 pack of 5

**B124** Brush size 1 pack of 5

**B127** Brush size 4 pack of 5

**B125** Brush size 2 pack of 5

**B195** Brushes one of each size (5)

## Single Bristle Brush

**Single Bristle Brush** for very fine manipulation of sections.

**B246** Single bristle brush (pack of 5)

## Ultraclear Specimen Tape

A super-clear tape ideal for collecting particles, fibres etc. for identification in the optical microscope, or where optical clarity is vital whilst maintaining the integrity of difficult sections such as bone or teeth.

**T 392/12** Ultraclear tape 12mm x 60m

**T392/50** Ultraclear tape 50mm x 60m

## U/M Chuck for Flat Embeddings

This specimen chuck is suitable for all Leica and RMC ultramicrotomes and enables secure clamping of flat embedded plastic blocks of varying thicknesses.

**M366** Ultramicrotome flat embedding chuck (specify make of microtome)

## U/M Chuck for Eppendorf Embeddings

After using Eppendorf tubes for processing and spinning down cells etc, the material is embedded *in-situ*. The resulting conical block is difficult to mount in a standard ultramicrotome specimen holder. These chucks have been specially designed to hold such embeddings securely.

**M401/R** Eppendorf chuck Leica/Reichert

**M401/L** Eppendorf chuck LKB

**M401/RM** Eppendorf chuck for RMC

**M401/RT** Eppendorf chuck RMC threaded

## Grid Coating Pen

A convenient system for providing an adhesive surface on TEM grid bars for secure attachment of sections and film coatings. Simply touch the pen onto the grid and a solvent containing an adhesive is released which finely coats the grid bars.

**P293** Grid coating pen



## Delimiting, Slide Adhesive and Film Writing Pens

### Super Pap-Pen Liquid Blocker

The Super Pap-Pen is designed to provide a water barrier when drawn around a specimen/section. It minimises antibody wastage on paraffin, plastic or frozen sections and cytological preparations. The formulation is water repellent, insoluble in alcohol and acetone and is stable for long periods up to 120°F. It is available in clear, red and blue all of which can be removed with xylene.



P283 Super Pap-Pen Clear

### Frozen Section Pen

A wide tipped pen designed to prevent frozen sections from falling off, moving or wrinkling on the slide during immunostaining procedures. The pen provides a sticky membrane that is applied to the slide before placement of the section. The membrane is stable up to 110°C and is suitable for vigorous applications such as *in situ* hybridisation and antigen retrieval by microwaving for frozen sections.

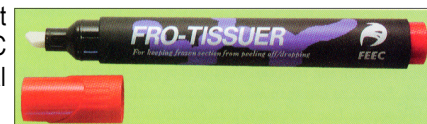

P285 Fro Tissuer Pen

### Tissue Capture Pen

This pen provides an adhesive membrane on the slide to prevent loss or wrinkling of paraffin sections. The sticky membrane flattens the section and can eliminate the need for hot water extension. It is suitable for microwave use and can be used with the Super Pap-Pen for small scale cultures. It is stable up to 120°C.



P498 Para-Tissuer Pen (tissue capture pen)

### Film Register Pen

With its dense opacity this Film Register pen is perfect for writing letters and numbers onto film in photo, medical and chemical applications. It is waterproof and writes on glass and metal as well as film. Available in black and red inks plus a solvent pen for easy correction.

- Flows smoothly on the surface of the film
- Produces an extra fine line
- Near perfect resistance to film cleaner
- Long lasting ink
- Does not contaminate by contact

P556 Black film register pen  
P556/R Red film register pen  
P556/S Solvent pen



See also page 22.34 for additional products

## Mounting Media

### Mount-Quick



A mounting medium in a tube. It dries quickly, gives easy control of dispensing, there is no density change if capped after every use and it has high transparency with no bubbles. It is long lasting both in the tube and on the slide. Soluble in xylene.  
*Specific gravity 0.89SP, Viscosity 33cP @ 25°C.*

**M402** Mount-Quick coverslip mounting medium 30g tube

### Mount-Quick Aqueous



A mounting medium developed for lipid and immunocytochemistry staining, especially with soluble chromogen solutions e.g. AEC when used with an organic solvent. Simply blot water from the slide, drop Mount-Quick Aqueous onto the section and gently lower the coverslip.

*Refractive index 1.41 Specific gravity 0.88 sp Viscosity 33cp @ 25°C pH 7.0*

**M403** Mount-Quick Aqueous 30g dropper

### Canada Balsam in Xylene

Refractive Index 1.522, Weight per ml @ 20°C 0.98g

**C403** Canada balsam in xylene 100ml

### Histomount

A polystyrene mountant for stained, dehydrated specimens with a R.I. of 1.50. Easy to use, mobile, crystal clear, rapid drying, non shrinking and stable. pH 6.6-7.1. *No fluorescence under UV.*

**M124** Histomount 500ml

### Mountex

A specially formulated acrylic resin to enable slides to be coverslipped from absolute alcohol thus eliminating the final xylene stages. Low viscosity, soluble in xylene and alcohol, neutral and colourless. R.I. 1.488

**M199** Mountex 1 litre

### DPX Mountants

A mixture of distyrene, a plasticiser and xylene. Perhaps the most well known of all mountants replacing xylene-balsam. A colourless synthetic mountant preserving the stain and drying quickly.

**M192/L** Low viscosity 500ml

**M192** Standard viscosity 500ml

**M192/T** Thick viscosity 500ml (Specially thickened for Cytology)

### Multipurpose Sealant/Varnish

A clear or black liquid sealant (nail varnish) that can be used to seal troughs or tape boats for ultramicrotomy, to attach hairs or fine wires to sticks to make fine probes, or to make a temporary seal around coverslips.

**S343** Clear sealant/varnish

**S343/B** Black sealant/varnish



See also  
Mountants  
page 22.34

## Static Line 2 Static Neutraliser

The Diatome 'Static Line 2' ionizer can dramatically improve ultramicrotomy of **frozen** and **room temperature** sections. The 'Static Line 2' emits negative and positive ions thus neutralising the static charges built up during sectioning. The variable voltage ensures the exact emission for the work in hand is achieved including trimming of cryo specimens.

At room temperature the high cutting forces that are needed to separate an ultrathin section from an insulating block of epoxy or acrylic material, leads to a highly charged sample surface. With a water bath this can result in the block face wetting, sections being pulled back over the knife edge, wrinkles distortion etc. The 'Static Line 2' can achieve perfect ribbons with virtually all specimens. With dry sections e.g. Lowicryl, the 'Static Line 2' prevents the loss of sections due to static attractions around the knife holder. Further literature available - please ask.

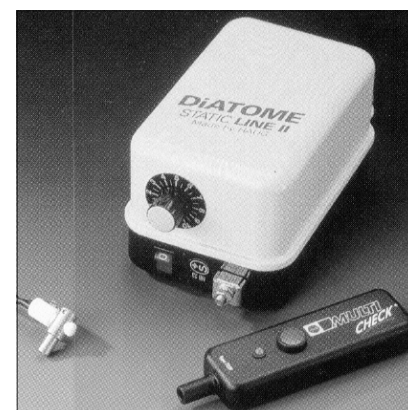

S348 Static Line 2 Ioniser 230V/115V 50-60Hz

## Specialised Filter/Blotting Papers

We can offer a range of fibre-free papers with a variety of properties for laboratory use. In the following tables the physical test data were obtained as follows:

**Filtration Time** - time in seconds to collect 100ml of water under a constant hydrostatic head as in BS6410.

**Retention Size** - the minimum size of spherical particles measured in micrometers, 90% of which will be retained by the paper under laboratory test conditions. The actual retention achieved under operating conditions will depend on the specific application.

**Pore Size** - the minimum and mean pore sizes have been determined using a Coulter Porometer and Porofil wetting fluid, both of which are industry standards for this test.

**Size** - The standard size we offer is 89 x 140mm but any size rectangular or circular is available on request. Minimum quantity of any size is 100 sheets.

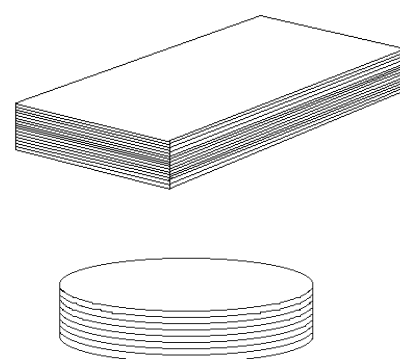

Product	Basis weight gm/sq meter	Filtration time secs	Retention size microns	Minimum pore size microns	Mean pore size microns	Catalogue number 89 x 140mm
<b>Creped Cellulose</b>						Box of 100 sheets
H w/s	60	23	25	7.9	16.5	F250
B w/s	90	72	10	6.1	9.8	F251
B140 w/s	140	28	13	7.8	14.2	F252
BT	180	195	9	4.3	8	F253
<b>Smooth Cellulose</b>						
TW w/s	70	135	6	5.5	8.1	F254
MW w/s	90	161	5	5.1	7.4	F255
E w/s	140	320	4	4.1	7.3	F256
P w/s	225	749	2.5	3.3	5.7	F257
W26 w/s	225	89	5	7.1	12	F258
TO w/s	280	459	3	3.9	6.7	F259
<b>Smooth Synthetic</b>						
V130	40	<1	160			F260
P150	50	<1	120			F261
R300	90	1.2	50			F262

## Vibroslice Automatic Tissue Slicers

British designed and built vibrating tissue slicers that will cut 50 to 700 $\mu$ m sections of fresh, unfixed tissue for in vitro recordings, tissue culture and microassay work. They can cut fixed material down to 20 $\mu$ m without previous embedding or freezing.

The blade oscillates at a fixed lateral displacement of 1.0mm at a frequency set by the user. Operation is actuated by a footswitch. The instruments have a removable tissue holder and bath which allows tissue to be prepared and stored ready for later use.



### Vibroslice HA752

This instrument offers manual advance of the section thickness and is recommended for use in producing a small number of sections or for use with tissues with differing mechanical properties.

**V090/230** Vibroslice HA752 230v 50Hz or **V090/115** 115v 60Hz



### Vibroslice MA752

This model offers motorised advance of the section thickness. Section thickness is selected on a rotary dial and the instrument is then operated via a footswitch leaving both hands free for other operations. Recommended for cutting serial sections for reconstruction or for producing multiple sections.

**V091/230** Vibroslice MA752 230v 50Hz or **V091/115** 115v 60Hz



### Vibroslice ROMA752

This remote motorised Vibroslice was designed specially for use with hazardous tissues such as those containing Prions or rabies infection. The cutting head, tissue bath and associated drive mechanisms are operated via an umbilical from the control box and thus can be placed inside a controlled environment. A tissue bath and cutting head capable of withstanding autoclaving at 140°C are included.

**V092/230** Vibroslice ROMA752 230v 50Hz or **V092/115** 115v 60Hz

### Vibroslice Accessories

All Vibroslices can be fitted with cutting heads and tissue baths that can be removed and sterilised by autoclave. Please ask.

**B294** 100 S/S injector blades in safety holder for Vibroslice  
**B294/RF** 100 blade refill for B294 (return to TAAB for loading)  
**B406** Injector style single edge blades PTFE coated pack of 20



## Vibrating Microtomes 5000mz & 7000smz

The Campden Instruments 5000mz and 7000smz are very competitively priced, high precision, vibrating microtomes. Tissue sectioning is made easy for the expert and beginner alike with a z-axis deflection of only 1-2 microns, and a blade advance controllable to 10 microns/sec. Sectioning for visual patching of neurological tissue, heart and lung have all been published using the previous generation of "Integralslice" machine from which the 5000mz represents a significant advance in higher precision at lower cost.

A completely new design of vibrating mechanism, with near silent operation and wider amplitude and speed ranges, gives the 5000mz and 7000smz much higher performance whilst keeping to a low cost. The user interface is completely new and extremely simple. Slicing begins at the touch of a button and a menu enables the setting of your own preferences.

Cooling is by either an ice-water bath or an electronically controlled thermo-electric cooler. Other options include the cold light and magnifier or stereo binocular for clear observation whilst slicing.

- Includes a z-axis calibration unit
- Z-axis blade adjust minimizer
- Blade holder angle to user requirement
- Set start and stop position from blade travel
- Vibration speeds from 50 to 120 Hz
- Amplitudes from 0.5mm to 2.5mm
- Controlled blade advance at 10microns per sec.
- Manual or automatic operation
- "Auto" programming by storage of the first slicing
- Ice water bath easily removed for cleaning
- Optional LED light and scope for clear observation

V106 Vibrating Microtome 5000mz      V107 Vibrating Microtome 7000smz



Vibrating Microtome 5000mz



Vibrating Microtome 7000smz

## Specifications

	5000mz	7000smz
Section thickness step size	0.001mm	0.001mm
Z axis deflection	1-2µm	sub micron
Blade oscillation frequency	25Hz	25Hz
Blade oscillation amplitude	2.0mm	2.25mm
Total travel of bath table	19mm	19mm
Bath table rise & fall speed	0.85mm/sec max	0.85mm/sec max
Cutting head speed resolution	0.01mm/sec	0.01mm/sec
Blade oscillation frequency	50Hz to 120Hz	50Hz to 120Hz
Dimensions less peripherals mm	H 270 x W 395 x D 390	H 270 x W 395 D 390

## Replacement Blades for all Tissue Choppers

- B294** 100 S/S injector blades in safety holder for 5000mz & 7000smz
- B294/RF** 100 blade refill for B294 (return to TAAB for loading)
- B581** Sapphire blades (each). See also page 12.16 for more details  
Blades can be resharpened
- B406** Injector style single edge blades PTFE coated      pack of 20  
38mm wide x 8mm high x 0.25mm thick (cutting edge 36.8mm long)



B406 PTFE coated blades

**New**

## RMC EM Products



A range of well designed and beautifully engineered instruments for specimen preparation and embedding and sectioning of specimens for electron microscopy at ambient and cryo temperatures.

### PT-PC PowerTome Ultramicrotome

A PC controlled ultramicrotome supplied complete with all-in-one slim design computer, with integrated "Touch Screen" control monitor, wireless mouse & keyboard, interconnect cables & accessories. All control functions are activated by touching the control monitor screen, or by mouse, or by using the digital controller. Color monitor displays bright, user friendly, control icons logically & clearly located around central video image display panel.

Please contact us for full specification.

**M404** MT-XL Ultramicrotome 230v 50Hz or 115v 60Hz

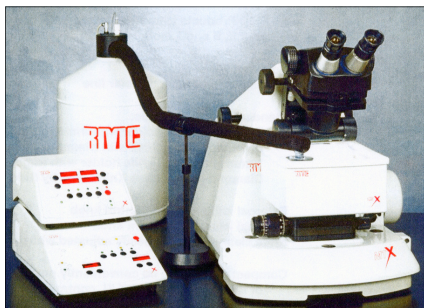

CR-X attached to MT-XL

### CR-X Cryosectioning System

An adaptable, user friendly cryosectioning system for RMC or Reichert/Leica ultramicrotomes. Quick fitting and removal, very low liquid N<sub>2</sub> consumption from 9 litre table top Dewar (< 0.75l/hour) yet giving quick response to temperature adjustments. Easy access into insulated cryo chamber with sectioning possible from +35° to -185°C (display resolution 0.1°C). External knife controls, dual rotating knife holder with trimming tool and complete accessory kit to start immediate cryosectioning. Separate power supply and control unit with microprocessor giving 4 user-adjustable programmes for knife and specimen temperatures. 10 each specimen mounting pins 2mm, 3mm, 6.5mm and flat specimen holder (clamping).

**M405** CR-X cryosectioning system 230v 50Hz or 115v 60Hz

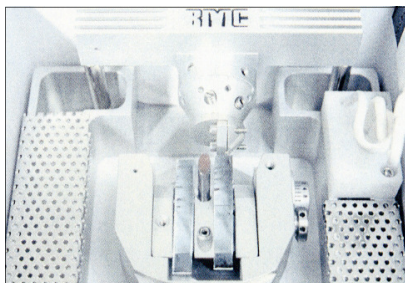

Interior view of cryochamber



CR-X attached to Ultracut ultramicrotome

### FS-7500 Freeze Substitution System

Trouble-free freeze substitution and low temperature embedding.

- Performs conventional and PLT (Progressive Lowering of Temperature) substitution
- User friendly controller holds up to 10 programmes
- 4 soak and 3 ramp settings for maximum process flexibility
- Low LN<sub>2</sub> coolant consumption
- Dewar refillable whilst substitution is in progress
- Wide choice of specimen holders

New "IMPS" processing chamber and flat embedding system incorporated.

**F317** FS-7500 freeze substitution system 115v 60Hz or 230v 50Hz



## Glass Knife Maker (RMC)

A precision instrument with micrometers for precise control and repeatable scoring. Uses "balanced break" method that allows for controlled slow breaking for optimum knife edges. The instrument body is machined from a solid block of metal for long term stability and precision. Uses 25mm wide glass strips from 6 to 12mm thick and can produce knives with cutting angles of 35° to 55° using micrometer adjustments.

*Dimensions:*

Width 360mm (14")  
Height 160mm (6.3")  
Depth 170mm (6.8")  
Weight 13.6Kg (30lbs)

*Comes complete with:* Protective goggles, brush, Instruction manual, Replacement scoring wheel and axle

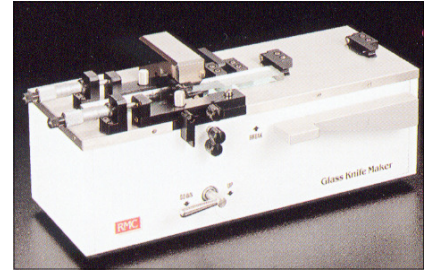

**K110** Glass knife maker RMC

## EMP-5160 Automatic Tissue Processor

If you are embedding TEM samples three or more times per week you need the EMP 5160. It uses a proven robotics system to move baskets of tissue from one vial to another. It can be programmed from the hand-held key pad to agitate the sample and maintain the temperature you desire. Microprocessor based with 50 built-in protocols and closed vials with vented hood so unit can be used in an open laboratory without exposing the operator to noxious fumes. Uses minimal reagents (2-18mls per sample).

**P557** EMP-5160 Automatic Tissue Processor

Supplied with the following: 1 set specimen handling tools, load & unload for specimen stack rings  
1 specimen load/unload plate for specimen baskets, 50 reagent vials with caps, 50 stack rings with mesh screens, 5 processing chambers, 1 basket holder assembly, 25 large, 3 compartment specimen baskets, 25 small, 4 compartment specimen baskets, 50 each EM grid baskets, 100 basket lids, 5 syringes, 30cc capacity, 3 meter exhaust hose, 1 programming keypad, 1 programmable data key, Instruction manual, Fuse kit, Cables



## QG-3100 Automated TEM Stainer

Automated programmable stainer for use with heavy metal salts such as lead citrate & uranyl acetate. Holds up to 40 EM grids per run with staining time typically 60-90 min and wash cycle time 5 min + 5 min

**Features:**

- Closed flow system provides clean conditions and exclusion of air
- Staining procedures are reliable and reproducible
- Exposure to staining solutions is minimized
- Extremely low operation costs
- Individual staining procedures may be easily configured
- Simple maintenance due to freely accessible tubing and valves
- Patented rotatable staining chamber

**S620** QG 3100 Automated TEM Stainer

Supplied complete with the following:

Main staining unit complete with peristaltic pump control valves, large illuminated touch screen controller/monitor, quick release processing chamber with grid loading plate, Grid loading/unloading tools, Cleaning holder, Filling syringe with weighted dispenser, Waste storage bottles with rack, Interconnect tubing, Drip tray, Power cord, Instruction manual

